

UNOPIU'

Outdoor
— 2024

UNOPIU'



Content Index

Collections - Index	5
Products - Index	7
Company	15
Designers	19
Materials	21
Sustainability	23
Metal Collections	25
Wooden Collections	97
Fibre Collections	187
Sunshades	215
Complements	269
Fabrics	301
Furnishings - Technical Sheets	319
Sunshades - Technical Sheets	367
Complements - Technical Sheets	409
Materials - Maintenance	423

Collections

Metal Collections



Davos
p. 27



Treble
p. 35



Nanda
p. 41



Lulù
p. 43



Coco
p. 45



Toscana
p. 55



Aurora
p. 63



Luce
p. 71



Ariete
p. 79



Panarea
p. 85



Conrad
p. 89



Fresbee
p. 95

Wooden Collections



Synthesis
p. 99



Ginger
p. 113



Amanda
p. 119



Chelsea
p. 123



Welcome
p. 133



Pevero
p. 141



Swing
p. 149



Clio
p. 155



Emy
p. 159



Titanic
p. 163



William
p. 169



C'est La Vie
p. 173



Cosette
p. 181

Fibre Collections



Agorà
p. 189



Experience
p. 199



Nacre
p. 205



Olimpia
p. 207



Capri
p. 211

Collections

Sunshades



Shibuya
p. 217



Tibisco
p. 223



Solaire
p. 229



Lipari
p. 235



Salento
p. 239



Damian
p. 243



Orangerie
p. 245



Manta
p. 251



Nagi
p. 255



Levante
p. 259



Covercar
p. 263



Dafne
p. 265

Complements



Aton
p. 271



Tratto
p. 275



Solare
p. 279



Hotty
p. 285



Carpets
p. 287



Vases
p. 291



Solar Shower
p. 293



Jolly Cushions
p. 297

Products

Sofas



Davos
p. 27



Treble
p. 35



Coco
p. 45



Toscana
p. 55



Aurora
p. 63



Luce
p. 71



Ariete
p. 79



Synthesis
p. 99



Synthesis
p. 99



Chelsea
p. 123



Welcome
p. 133



Pevero
p. 141



C'est La Vie
p. 173



Agorà
p. 189



Experience
p. 199



Olimpia
p. 207

Chairs Small armchairs



Coco
p. 45



Toscana
p. 55



Aurora
p. 63



Aurora
p. 63



Luce
p. 71



Ariete
p. 79



Conrad
p. 89



Synthesis
p. 99



Ginger
p. 113



Chelsea
p. 123



Pevero
p. 141



Pevero
p. 141



William
p. 169



Cosette
p. 181



Agorà
p. 189



Experience
p. 199



Experience
p. 199



Capri
p. 211

Products

Armchairs



Davos
p. 27



Treble
p. 35



Nanda
p. 41



Lulù
p. 43



Coco
p. 45



Toscana
p. 55



Aurora
p. 63



Luce
p. 71



Ariete
p. 79



Synthesis
p. 99



Synthesis
p. 99



Chelsea
p. 123



Chelsea
p. 123



Welcome
p. 133



Welcome
p. 133



Pevero
p. 141



Emy
p. 159



C'est La Vie
p. 173



Agorà
p. 189



Experience
p. 199



Nacre
p. 205



Olimpia
p. 207

Stools



Coco
p. 45



Coco
p. 45



Luce
p. 71



Conrad
p. 89



Conrad
p. 89



Conrad
p. 89



Swing
p. 149



Swing
p. 149

Products

Tables



Coco
p. 45



Toscana
p. 55



Toscana
p. 55



Toscana
p. 55



Toscana
p. 55



Aurora
p. 63



Luce
p. 71



Luce
p. 71



Ariete
p. 79



Conrad
p. 89



Conrad
p. 89



Conrad
p. 89



Synthesis
p. 99



Synthesis
p. 99



Synthesis
p. 99



Synthesis
p. 99



Chelsea
p. 123



Chelsea
p. 123



Chelsea
p. 123



Pevero
p. 141



Pevero
p. 141



C'est La Vie
p. 173



C'est La Vie
p. 173



Cosette
p. 181



Agorà
p. 189



Agorà
p. 189



Experience
p. 199

High Tables



Coco
p. 45



Luce
p. 71



























Luce
p. 71



Conrad
p. 89

Products

Coffee tables

				
Davos p. 27	Davos p. 27	Treble p. 35		
				
Coco p. 45	Toscana p. 55	Toscana p. 55	Luce p. 71	Luce p. 71
				
Panarea p. 85	Synthesis p. 99	Synthesis p. 99	Synthesis p. 99	Synthesis p. 99
				
Chelsea p. 123	Chelsea p. 123	Welcome p. 133	Welcome p. 133	Pevero p. 141
				
Pevero p. 141	Pevero p. 141	Pevero p. 141	C'est La Vie p. 173	Agorà p. 189
				
Agorà p. 189	Experience p. 199	Olimpia p. 207		

Products

Sunloungers Chaise longues

				
Coco p. 45	Aurora p. 63	Luce p. 71		
				
Panarea p. 85	Synthesis p. 99	Synthesis p. 99	Synthesis p. 99	Synthesis p. 99
				
Synthesis p. 99	Amanda p. 119	Chelsea p. 123	Pevero p. 141	Pevero p. 141
				
Swing p. 149	Clio p. 155	Titanic p. 163	C'est La Vie p. 173	C'est La Vie p. 173
				
Agorà p. 189	Agorà p. 189	Experience p. 199		

Products

Lightings and Complements



Aurora
p. 63



Chelsea
p. 123



Aton
p. 271



Tratto
p. 275



Solare
p. 279



Hotty
p. 285



Carpets
p. 287



Vases
p. 291



Solar Shower
p. 293



Jolly Cushions
p. 297

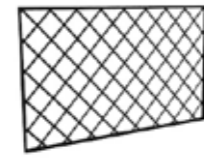

Iron Panels
p. 397, 401



Wooden Panels
p. 378, 382, 383



Concrete Vases
p. 418



Iron Planters
p. 400



Wooden Flower Pots
p. 378, 384

Sunshades



Shibuya
p. 217



Tibisco
p. 223

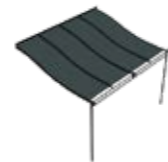

Tibisco
p. 223



Tibisco
p. 223



Solaire
p. 229



Solaire
p. 229



Solaire
p. 229



Lipari
p. 235



Salento
p. 239



Salento
p. 239



Damian
p. 243



Orangerie
p. 245



Orangerie
p. 245



Manta
p. 251



Nagi
p. 255



Levante
p. 259



Covercar
p. 263



Dafne
p. 265



En ->

Unopiù, leading company in the production and distribution of outdoor design furniture and accessories, was founded in the heart of Tuscany over forty years ago. The philosophy behind the name 'Unopiù' stems from the desire to create 'ONE MORE ROOM', that extra space dedicated to the outdoors. The company's mission is to furnish any outdoor space in the house with the same care and passion usually reserved for interiors, envisioning and recreating spaces in a functional and elegant way so as to experience inspirational moments of relaxation in a perfect Italian style. The company provides a total look for any type of environment, from terraces and large gardens to the outdoor environments in resorts, hotels and on yachts. All the creations by Unopiù have been made to last over time, thanks to the selection of unrivalled materials, which are weather resistant, even in the most extreme conditions.

It ->

Unopiù, azienda leader nella produzione e distribuzione di arredi e accessori di design per esterni, nasce in Italia nel cuore della Toscana più di quarant'anni fa. La filosofia dietro al nome "Unopiù" nasce dalla volontà di creare 'UNA STANZA IN PIU', ovvero quello spazio in più dedicato all'outdoor. Missione dell'azienda è arredare ogni spazio esterno della casa con la cura e la passione che vengono dedicate agli interni, pensando e organizzando gli spazi in modo funzionale ed elegante per vivere momenti ispirazionali e di relax in perfetto stile italiano. "L'azienda offre un "total look" per qualsiasi tipo di ambiente, dalla terrazza, ai grandi giardini, fino agli ambienti esterni di resort, hotel e yachts. Tutte le creazioni di Unopiù sono realizzate per durare nel tempo, grazie alla selezione di materiali dalla qualità impareggiabile, in grado di resistere a tutti gli agenti atmosferici, anche i più estremi.

Fr ->

Unopiù, entreprise leader dans la production et distribution de meubles et accessoires design d'extérieur, naît en Italie au cœur de la Toscane il y a plus de quarante ans. La philosophie derrière le nom "Unopiù" trouve son origine dans la volonté de créer UNE PIECE EN PLUS, c'est-à-dire cet espace en plus dédié à l'extérieur. La mission de la société est de meubler chaque espace extérieur avec le même soin et passion consacrés à l'intérieur, en pensant et en organisant les espaces de manière fonctionnelle et élégante pour vivre des moments inspirants et de détente dans le parfait style italien. L'entreprise offre un « total look » à tous les types d'environnements, de la terrasse aux grands jardins, en passant par les espaces extérieurs de complexes touristiques, hôtels et yachts. Toutes les créations d'Unopiù sont réalisées pour durer dans le temps, grâce à la sélection de matériaux de qualité incomparable, capables de résister à tous les agents atmosphériques, même les plus extrêmes.

Since its very beginning, Unopiù has had a vision: to see the outdoors as an additional space, to be furnished using versatile, elegant and functional solutions, created to last over time by adapting harmoniously to the environment. The Company today is considered one of the main reference points in the outdoor sector, that is perceived as a place to spend time in communion with Nature, to benefit from the sensations of comfort, well-being, and freedom it offers.

Unopiù nasce dalla volontà di immaginare l'esterno come uno spazio aggiuntivo da arredare attraverso soluzioni versatili, eleganti e funzionali, nate per durare nel tempo adattandosi all'ambiente in modo armonioso. L'Azienda rappresenta oggi uno dei punti di riferimento più significativi del mondo dell'outdoor, visto come luogo dove trascorrere il tempo in comunione con la Natura, per beneficiare delle sensazioni di comfort, benessere, libertà che offre.

Unopiù nait de la volonté d'imaginer l'extérieur comme un espace supplémentaire à meubler grâce à des solutions polyvalentes, élégantes et fonctionnelles, nées pour durer dans le temps tout en s'adaptant à l'environnement de manière harmonieuse. L'entreprise représente aujourd'hui l'un des points de référence les plus significatifs du monde de l'outdoor, considéré comme un lieu où passer du temps en communion avec la nature, pour bénéficier de sensations de confort, de bien-être et de liberté.

En -

In 1978, Unopiù was the first brand to design furniture entirely dedicated to the outdoors, and since then it has been an international reference, thanks to its unique heritage. Since its very beginning, the Company's goal has been to furnish the outdoors with the same attention and care usually reserved for interiors, creating functional and esthetically elegant spaces, and providing them with complete and tailored solutions: from seating and structures to furniture accessories. Products by Unopiù, many of them created by well-known designers, are timeless proposals, in terms of both quality and design aesthetic criteria. The best terraces and outdoor spaces of renowned hotels and Resorts - including the Bulgari Hotel, the Mandarin Oriental Hotel, the Greenwich Hotel in New York, and the Four Seasons Resort in Hawaii, the Hilton West Palm Beach in Florida, Garage Italia Custom in Milan, the Cipriani Hotel in Vernice, the Gran Melià in Rome, the Argentario Golf Resort & Spa, the Verdura Resort in Sciacca, the W Hotel in Saint Petersburg, illy Café in Milan, the Westin Resort in Costa Navarino (Greece) and the Relais & Chateaux Sol y luna in Urubamba (Perù). The most recently completed projects are the One & Only Royal Mirage in Dubai, the Grand Hotel Via Veneto in Rome and the Abi d'Oru Hotel in Sardinia. Unopiù has an extensive global presence, with 10 flagship stores, in the Brera district in Milan and in the Boulevard Saint-Germain, in Paris.

It -

Unopiù nel 1978 è stato il primo brand a progettare arredi interamente dedicati all'outdoor, e da allora rappresenta un punto di riferimento internazionale, grazie ad un heritage unico. Fin dall'inizio, l'obiettivo dell'azienda è stato quello di arredare ogni spazio outdoor con la stessa cura e attenzione solitamente rivolti all'interior design, creando spazi funzionali ed esteticamente eleganti con soluzioni di arredo complete e su misura: dalle sedute, alle strutture, fino ai complementi. I prodotti Unopiù, molti firmati da noti designer, sono proposte 'senza tempo', sia in termini di qualità sia come canoni estetici di design. Unopiù nel tempo ha arredato le migliori terrazze e spazi esterni di rinomati hotel e resort, tra cui Bulgari Hotel, Mandarin Oriental Hotel, Greenwich Hotel di New York, Four Season Resort alle Hawaii, l'Hilton West Palm Beach in Florida, il Garage Italia Custom di Milano, l'Hotel Cipriani di Venezia, il Gran Melià di Roma, l'Argentario Golf Resort & Spa, il Verdura Resort di Sciacca, il W Hotel di San Pietroburgo, illy Café a Milano, il Westin Resort a Costa Navarino (Grecia) e il Relais & Chateaux Sol y luna a Urubamba (Perù). Gli ultimi progetti completati sono il One & Only Royal Mirage a Dubai, il Grand Hotel Via Veneto a Roma e l'Hotel Abi d'Oru in Sardegna. Unopiù ha un'ampia presenza globale con 10 negozi monomarca, in Brera a Milano e in boulevard Saint-Germain a Parigi.

Fr -

En 1978, Unopiù fut la première marque concevant du mobilier entièrement dédié à l'extérieur et, depuis lors, elle constitue une référence internationale, grâce à son patrimoine unique. Dès le début, l'objectif de l'entreprise a été de meubler chaque espace extérieur avec le même soin et attention généralement consacrés au design d'intérieur, en créant des espaces fonctionnels et esthétiquement élégants avec des solutions d'ameublement complètes et sur mesure : des assises aux structures jusqu'aux compléments. Les produits Unopiù, dont beaucoup sont signés par des designers de renom, sont proposés 'intemporellement', soit en termes de qualité, soit en tant que canons esthétiques de design. Unopiù, au fil du temps, a meublé les plus belles terrasses et espaces extérieurs d'hôtels et de complexes illustres, dont l'Hôtel Bulgari, l'Hôtel Mandarin Oriental, l'Hôtel Greenwich à New York, le Four Season Resort à Hawaï, le Hilton West Palm Beach en Floride, le Garage Italia Custom à Milan, l'hôtel Cipriani à Venise, le Gran Melià à Rome, l'Argentario Golf Resort & Spa, le Verdura Resort à Sciacca, le W Hotel à St Petersburg, illy Café à Milan, le Westin Resort à Costa Navarino (Grèce) et le Relais & Châteaux Sol y luna à Urubamba (Pérou). Les derniers projets achevés sont le One & Only Royal Mirage à Dubai, le Grand Hotel Via Veneto à Rome et l'Hotel Abi d'Oru en Sardaigne. Unopiù a une large présence mondiale avec 10 magasins, à Brera à Milan et boulevard Saint-Germain à Paris.

Designers



Marco Acerbis
Andrea Andretta
Andreucci & Hoisl
Stefano Boeri
Michele Bönan
Daniel Jarefeldt
Ferruccio Laviani
Matteo Nunziati
Meneghello & Paoletti
Studiomartino.5
Studio Adolini
Adam D. Tihany
Gio Tiroto

En

Unopiù projects its vision of the outdoors through the eyes of designers that, inspired by traditions, give form to the Company's values creating signature products that embody the quality and unique style of Unopiù.

It

Unopiù interpreta la visione dello stile outdoor attraverso lo sguardo dei designer che, ispirati dalla tradizione, hanno tradotto i valori dell'azienda firmando prodotti capaci di raccontare la qualità e lo stile unico di Unopiù.

Fr

Unopiù interprète la vision du style outdoor à travers le regard des designers qui, inspirés par la tradition, ont traduit les valeurs de l'entreprise en signant des produits capables de raconter la qualité et le style unique d'Unopiù.

Materials

En -

In order to create outdoor furniture that will last outside for an infinite amount of time, it is constantly necessary to research, choose and use raw materials with unique characteristics. Unopiù materials are always selected with strict criteria to ensure unrivalled resistance to all weather conditions, even when most extreme, making the furniture ideal for any outdoor or indoor space. To meet and satisfy all requirements, Unopiù uses fine materials such as high-quality wood including teak, mahogany, iroko and pine, metals (iron, steel and aluminium), fibres and synthetic rope, and fabrics.

It -

Per creare mobili per outdoor che resistano un tempo infinito all'aperto, è costantemente necessario ricercare, scegliere e utilizzare materie prime dalle caratteristiche uniche. I materiali Unopiù sono sempre selezionati con criteri rigorosi per garantire un'impareggiabile qualità di resistenza a tutti gli agenti atmosferici, anche i più estremi, in modo da rendere gli arredi ideali per qualsiasi spazio esterno e interno. Per rispondere e soddisfare tutte le esigenze, Unopiù utilizza materiali di eccellenza come legni pregiati quali teak, mogano, iroko e pino, metalli (ferro, acciaio, alluminio), fibre e corda sintetica, tessuti.

Fr -

Afin de créer des meubles d'extérieur qui dureront un temps infini à l'extérieur, il est constamment nécessaire de rechercher, de choisir et d'utiliser des matières premières aux caractéristiques uniques. Les matériaux Unopiù sont toujours sélectionnés selon des critères rigoureux afin de garantir une qualité inégalée de résistance à toutes les conditions météorologiques, même les plus extrêmes, ce qui rend le mobilier idéal pour tout espace extérieur ou intérieur. Pour répondre à toutes les exigences, Unopiù utilise des matériaux d'excellence tels que des bois précieux comme le teck, l'acajou, l'iroko et le pin, des métaux (fer, acier, aluminium), des fibres et des cordes synthétiques, des tissus.





Sustainability

En -

The use and processing of natural resources requires great responsibility for the natural environment, its protection and preservation. This ethical commitment and promise are reflected in the philosophy, aspirations and in every project by Unopiù. The continuous search for excellence and innovation, which is supported from the outset by the desire to keep the quality standards high while maintaining a responsible attitude towards raw materials and the environment, has led Unopiù to focus on creating designer furniture elements that are sustainable and attractive, without losing their appeal and value over time. The selection of materials during the design phase and the company's production choices contribute to the longevity of each piece of furniture, thus making it sustainable, a concept which for Unopiù is inherent in the product itself.

It -

L'utilizzo e la lavorazione di risorse naturali impone grande responsabilità nei confronti dell'ambiente naturale, della sua tutela e della sua salvaguardia. Un impegno etico e una promessa rispecchiati dalla filosofia, dalle aspirazioni e da ogni progetto firmato Unopiù. La continua ricerca di eccellenza e innovazione – sostenuta fin da subito dalla volontà di mantenere alti standard qualitativi conservando un atteggiamento fortemente responsabile verso materie prime e ambiente – ha portato Unopiù a focalizzarsi su una produzione di elementi d'arredo di design che siano sostenibili e che abbiano la facoltà di attrarre senza perdere appeal e valore nel tempo. La selezione dei materiali in fase progettuale e le scelte produttive dell'azienda contribuiscono alla longevità di ogni mobile, rendendolo quindi sostenibile, perché per Unopiù il concetto di sostenibilità è connotato nel prodotto stesso.

Fr -

L'utilisation et la transformation des ressources naturelles imposent une grande responsabilité vis-à-vis de l'environnement naturel, de sa protection et de sa préservation. Un engagement éthique et une promesse qui se reflètent dans la philosophie, dans les aspirations et dans chaque projet d'Unopiù. La recherche continue de l'excellence et de l'innovation – soutenue dès le départ par le désir de maintenir des normes de qualité élevées tout en conservant une attitude fortement responsable à l'égard des matières premières et de l'environnement – a porté Unopiù à se concentrer sur la production de meubles design durables et ayant la capacité d'attirer sans perdre leur attrait et leur valeur au fil du temps. La sélection des matériaux lors de la phase de conception et les choix de production de l'entreprise contribuent à la longévité de chaque meuble, le rendant ainsi durable car, pour Unopiù, le concept de durabilité est inhérent au produit lui-même.

Metal Collections

01.

Davos
Treble
Nanda
Lulú
Coco
Toscana
Aurora
Luce
Ariete
Panarea
Conrad
Fresbee

Davos Collection

Design by
Matteo Nunziati



En -

Design by Matteo Nunziati, Davos is a seating system with infinitely modular elements, designed to be used seamlessly both inside and outdoors, thanks to padding and fabrics that replicate the comfort and softness of indoor furnishings. The very lightweight structure is easy to transport and can be assembled in an intuitive way due to the highly sophisticated and innovative production technology. The name is a tribute to the Swiss city at the centre of the Walser population, which has influenced the design of the collection.

It -

Firmato dal designer Matteo Nunziati, Davos è un sistema di sedute a elementi modulabili all'infinito, progettato senza soluzione di continuità tra indoor e outdoor, grazie ad una imbottitura e a tessuti che replicano il comfort e la morbidezza degli arredi da interno. La struttura, molto leggera, è facilmente trasportabile e componibile in modo intuitivo grazie ad una tecnologia di produzione altamente sofisticata ed innovativa. Il nome è un omaggio alla città svizzera al centro della popolazione Walser, che ha influenzato il design della collezione.

Fr -

Signé par le designer Matteo Nunziati, Davos est un ensemble d'éléments modulables à l'infini, conçu de manière à assurer une continuité entre intérieur et extérieur, grâce à un rembourrage et à des tissus qui reproduisent le confort et la douceur du mobilier d'intérieur. La structure, très légère, est facilement transportable et modulable de manière intuitive grâce à une technologie de fabrication hautement sophistiquée et innovante. Le nom est un hommage à la ville suisse au centre de la population Walser, qui a influencé le design de la collection.



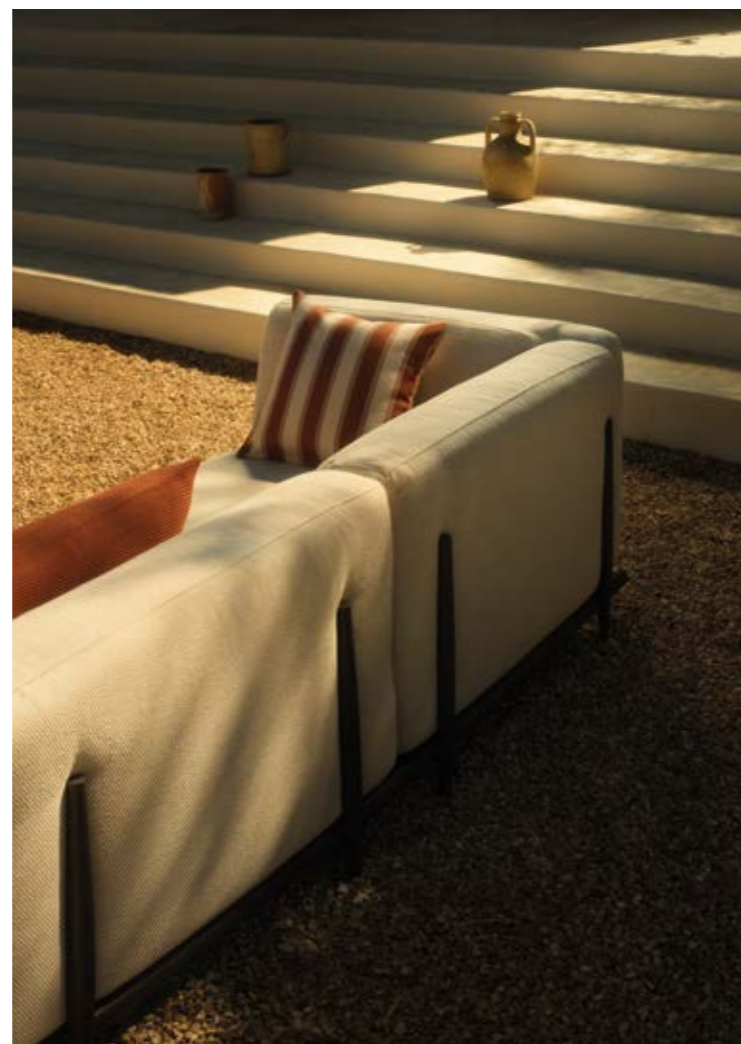

En -

The aesthetics of the Davos seating system draw inspiration from the rural architecture of the houses of the Walser population. Easy to handle even the soft part of the sofa: the cushions that are placed and fixed on the frame are easily removed in case of adverse weather events or even only at the end of the season.

It -

L'estetica del sistema di sedute Davos trae ispirazione dall'architettura rurale delle case della popolazione Walser. Di facile gestione anche la parte morbida del divano: i cuscini che vengono appoggiati e inseriti sul telaio sono rimovibili facilmente in caso di eventi atmosferici avversi o anche solo a fine stagione.

Fr -

L'esthétique des éléments modulables Davos s'inspire de l'architecture rurale des maisons locales. La partie souple du canapé est également facile à manipuler : les coussins qui sont posés et fixés sur le cadre peuvent être facilement enlevés en cas d'événements météorologiques défavorables ou même à la fin de la saison.





En -

The joints designed for the aluminum structure reflect the wooden ones typical of the historic buildings of this mountain context. The joints present in the structure of the seats are reproduced in the coffee tables in porcelain stoneware, contributing to the great modularity of the collection.

It -

I giunti studiati per la struttura in alluminio riprendono quelli in legno tipici degli edifici storici di questo contesto montano. I giunti presenti nella struttura delle sedute sono riprodotti nei tavolini in grès porcellanato, contribuendo alla grande modularità della collezione.

Fr -

Les jointures étudiées pour la structure en aluminium reprennent celles en bois typiques des bâtiments historiques de ce contexte montagnard. Les jointures présentes dans la structure des sièges sont reproduites dans les tables basses en grès cérame, contribuant à la grande modularité de la collection.

Treble Collection



En -

Bi-material, the Treble collection is characterised by its lightness, clean lines, high performance when used outdoors and its aesthetic rigour, qualities that make it easily adaptable to urban and residential settings. There are four finishes for the frame and weave: graphite, sage, syrah and sand. In addition to the modular seating, a rectangular coffee table is also available with a solid teak top.

It -

Bimaterica, in alluminio e corda, la collezione Treble si caratterizza per la leggerezza, la purezza delle linee, l'alta performance nell'utilizzo outdoor e il rigore estetico, qualità che la rendono facilmente adattabile a contesti urbani e residenziali. Quattro le finiture della struttura e dell'intreccio: grafite, salvia, syrah e sabbia. Oltre alle sedute modulari è disponibile anche un coffee table rettangolare con solido piano in teak.

Fr -

Bi-matière, en aluminium et corde, la collection Treble se caractérise par la légèreté, la pureté des lignes, l'excellente résistance en extérieur et la rigueur esthétique, des qualités qui lui permettent de s'adapter aux contextes urbains et résidentiels. Quatre finitions de la structure et du tressage : graphite, sauge, syrah et sable. En plus des sièges modulaires, une table basse rectangulaire avec plateau en teck massif complète l'ensemble.



En -

Precious detail, the handcrafted weave of synthetic rope - a material that offers a high performance of weather resistance while recalling to the eye and touch the warmth and softness of natural rope - draws armrests and backrest of the armchair, sofa and modular system.

It -

Prezioso dettaglio, l'intreccio artigianale di corda sintetica - materiale che offre un'elevata performance di resistenza alle intemperie pur richiamando alla vista e al tatto il calore e la morbidezza della corda naturale - disegna braccioli e schienale della poltrona, del divano e del sistema modulare.

Fr -

Détail précieux, le tressage artisanal en corde synthétique - matériau qui offre une grande résistance aux intempéries tout en rappelant à la vue et au toucher la chaleur et la douceur de la corde naturelle - dessine les accoudoirs et le dossier du fauteuil, du canapé et du système modulaire.





Nanda Collection

Design by
Gio Tiroto

En -

Nanda, by Gio Tiroto, is inspired by the wonderful bergère, an armchair that has won over and influenced artists and designers from the eighteenth century to the present day. The minimalist design of Nanda deconstructs the iconic bergère by making limited use of materials, giving it a decidedly contemporary appeal, perfect for outdoors. The Nanda frame is made of galvanised and powder coated iron in the colour of sand or graphite, and it has been carefully designed to be easily stackable. The seat padding is made of Batyline Serge Ferrari fabric in the shades of brick red and sand.

It -

Nanda, firmata da Gio Tiroto, si ispira alla meravigliosa bergère, poltrona che ha influenzato artisti e designer dal Settecento fino ai giorni nostri. Il disegno minimalista di Nanda, destruttura l'iconica poltrona, facendo un uso minimo di materiali, conferendole un appeal decisamente contemporaneo, perfetto per l'outdoor. La struttura di Nanda è realizzata con ferro zincato e verniciato color sabbia o grafite, e grazie a un'attenta progettazione, è facilmente impilabile. L'imbottito della seduta è realizzato in tessuto Batyline Serge Ferrari nelle tinte del mattone e sabbia.

Fr -

Nanda, signée par Gio Tiroto, s'inspire de la merveilleuse bergère, fauteuil qui conquiert et influence artistes et designers du XVIIIe siècle jusqu'à nos jours. Le design minimaliste de Nanda, déstructure la bergère iconique en utilisant un minimum de matériaux, lui donnant ainsi un attrait résolument contemporain, parfait pour le grand air. La structure de Nanda est réalisée en fer galvanisé et peint de couleur sable ou graphite, et grâce à une conception minutieuse, est facilement empilable. Le rembourrage de l'assise est réalisé en tissu Batyline Serge Ferrari dans les teintes brique et sable.

Lulù Collection

Design by
Daniel Jarefeldt



En

Lulù is a lounge chair, designed by Daniel Jarefeldt, for a wide range of environments, both public and private, outdoor and indoor. Lulù has an elegant and timeless identity but at the same time playful and light, because it resembles a swing. The inspiration initially derives from rattan easy chairs from the 1950s but the form is rationalised into a more contemporary look. The hanging seat in canvas also references classic sun chairs and contributes to a design that gives a light and easy impression. The material palette of coloured metal, warm textile, tactile leather and wooden details contribute to a sophisticated and elegant appearance.

It

Lulù è una poltrona lounge, progettata da Daniel Jarefeldt, per un'ampia gamma di ambienti, sia pubblici che privati, sia indoor che outdoor. Lulù ha un'identità elegante e senza tempo ma al contempo giocosa e leggera, perché ricorda un'altalena. L'ispirazione deriva inizialmente dalle poltrone in rattan degli anni Cinquanta, ma la forma viene razionalizzata in un look più contemporaneo. Anche la seduta sospesa in tela fa riferimento alle classiche sedie a sdraio e conferisce un design che dà un'impressione di leggerezza e semplicità. La palette dei materiali, composta da metallo colorato, tessuto caldo, pelle tattile e dettagli in legno, contribuisce a creare un aspetto sofisticato.

Fr

Lulù est un fauteuil lounge conçu par Daniel Jarefeldt, pour une large gamme d'espaces, à la fois publics et privés, intérieurs et extérieurs. Lulù a une identité élégante et intemporelle, mais aussi ludique et légère, puisqu'elle ressemble à une balançoire. L'inspiration vient initialement des fauteuils en rotin des années 1950, mais la forme est rationalisée dans un look plus contemporain. Le siège suspendu en toile fait également référence aux chaises longues classiques et contribue à distiller un design qui donne une impression de légèreté et de simplicité. La palette des matériaux, composée de métal coloré, de tissu chaud, de cuir tactile et de détails en bois, contribue à créer un aspect sophistiqué.

Coco Collection

Design by
Andrea Andretta



En -

Inspired by the iconic chair from the '70s, Andrea Andretta's new Coco collection brings contemporary freshness and purity of lines, without forgetting its roots, identity, and the essence of Italian lifestyle. Lightness, versatility, and a three-dimensional twist are the main assets of the Coco collection. A cool design with an aesthetic reading: the frame - a tubular galvanized iron structure - and the polypropylene cord, stretched and braided, are the common thread at the heart of the collection.

It -

Ispirata all'iconica sedia degli anni '70, la nuova collezione Coco di Andrea Andretta porta con sé freschezza contemporanea e purezza di linee, senza dimenticare le radici, l'identità e l'essenza del lifestyle italiano. Leggerezza, versatilità e tridimensionalità sono i punti di forza della collezione Coco. Un design fresco con una lettura estetica: il telaio - una struttura tubolare in ferro zincato - e la corda in polipropilene, tesa e intrecciata, sono i punti di forza della collezione Coco.

Fr -

Inspirée de la chaise emblématique des années 70, la nouvelle collection Coco d'Andrea Andretta affiche une fraîcheur contemporaine et des lignes épurées, tout en préservant ses racines, son identité et l'essence de l'art de vivre à l'italienne. Légèreté, polyvalence et tridimensionnalité sont les principaux atouts de la collection Coco. Un design frais faisant montre d'un souci esthétique : l'armature, une structure tubulaire en fer galvanisé, et la corde en polypropylène tendue et tressée sont le fil rouge de la collection Coco.



En -

Coco is a collection that is eminently suitable for all traditional garden locations, but is designed with contemporary urban contexts in mind, making it interesting for contract use to pubs, cafes, public dining, and any other entertainment-type venues.

It -

Coco è una collezione che si adatta perfettamente a tutti i giardini tradizionali, ma è stata progettata pensando ai contesti urbani contemporanei, rendendola interessante per l'uso contract in pub, caffè, ristoranti e qualsiasi altro luogo di intrattenimento.

Fr -

La collection Coco s'intègre parfaitement dans tous les jardins traditionnels et a été conçue en tenant compte des contextes urbains contemporains. Ceci la rend particulièrement adaptée aux pubs, cafés, restaurants et autres lieux de divertissement.





En -
 Andrea Andretta is expanding his collection with four new entries with a contemporary design, in line with the retro concept and style of Coco: a lounge, with a graphite-coloured steel frame equipped with two wheels and ecru rope; a round dining table decorated with rope details; a bar table and stool, especially suitable for contract settings.

It -
 Andrea Andretta nel 2024 espande la sua collezione con quattro new entry dal disegno contemporaneo, in linea con il concetto retro e lo stile di Coco: un lettino, con una struttura in acciaio color grafite dotata di due rotelle e corda écru; un tavolo dining rotondo impreziosito da dettagli in corda; uno sgabello e un tavolino da bar, adatti soprattutto a contesti contract.

Fr -
 Andrea Andretta développe sa collection en 2024 avec quatre nouveaux arrivants au design contemporain, en phase avec le concept rétro et le style de Coco: un bain de soleil, avec une structure en acier couleur graphite équipée de deux roulettes et une corde écru; une table dining ronde ornée de détails en corde; un tabouret et une table hauts, particulièrement adaptés à l'univers Contract.





En -
Ease of handling is
ensured by the large
wheels at the rear, which
allow it to be moved
practically.

It -
La maneggevolezza del
lettino è garantita dalle
grandi ruote posteriori che
consentono di spostarlo
con praticità.

Fr -
La maniabilité du bain de
soleil est garantie par les
grandes roues arrière qui
permettent de le déplacer.

Toscana Collection



En -

The Toscana collection is a classic icon of handcrafted production in powder-coated galvanized iron. Quality craftsmanship and attention to detail by expert artisans translate into structures with thin and geometric volumes with a contemporary geometric design that characterizes all the elements of the line.

It -

La collezione Toscana è una classica icona di produzione artigianale a mano realizzata in ferro zincato verniciato a polveri. La maestria e l'attenzione al dettaglio di esperti artigiani si traducono in strutture dai volumi geometrici sottili il cui design contemporaneo e geometrico caratterizza tutti gli elementi.

Fr -

La collection Toscana est une icône classique de la production artisanale faite à la main en fer galvanisé et peinture poudre. Le savoir-faire et l'attention au détail d'artisans expérimentés se traduisent par des structures aux volumes géométriques et subtiles, dont le design contemporain et précis caractérise tous les éléments.



En -

The galvanised iron frame of the tables, which is slender and light, can be customised with tops in various shapes and sizes. The round table features a hole in the centre, while the rectangular version is extendable up to a size of 300 cm.

It -

La struttura dei tavoli in ferro zincato, slanciata e leggera, si personalizza con piani di diverse forme e dimensioni. Il tavolo rotondo è caratterizzato da un foro centrale, mentre la versione rettangolare è allungabile sino ad una dimensione di 300 cm.

Fr -

La structure des tables en fer galvanisé, élancée et légère, est personnalisée avec des plateaux de différentes formes et tailles. La table ronde se caractérise par un trou central, tandis que la version rectangulaire est extensible jusqu'à une taille de 300 cm.







En -
The ends of the armrests
of the folding armchair
are curled, giving it a
classic, romantic look.

It -
L'estremità del bracciolo
della poltroncina pieghevole
termina in un motivo
a ricciolo, donandole
un aspetto classico
e romantico.

Fr -
L'extrémité de l'accoudoir
de la chaise pliante
se termine par un motif
de tourbillon, ce qui lui
donne un look classique
et romantique.



Aurora Collection



En

A romantic spirit characterizes this timeless collection: hand-forged and inspired by the Umbrian-Tuscan tradition of the late 1900s, Aurora comes out refined and traditional thanks to its stylishly sinuous shapes. Its powder-coated wrought iron structure is its signature trait, which sums up the perfect combination of elegance and durability.

It

Un'anima romantica caratterizza questa collezione senza tempo: forgiata a mano e ispirata alla tradizione umbro-toscana di inizio '900, Aurora si presenta raffinata e tradizionale grazie alle forme sinuose e chic. La distingue la struttura in ferro battuto verniciata a polveri, che riassume il perfetto connubio tra eleganza e durevolezza.

Fr

Une âme romantique caractérise cette collection intemporelle: forgée à la main et inspirée par la tradition ombro-toscane du début du XXème siècle, Aurora est raffinée et traditionnelle grâce à ses formes sinueuses et chics. Elle se distingue par sa structure en fer forgé peinture poudre, qui résume la combinaison parfaite entre élégance et durabilité.





En -

Timeless beauty and romantic lines, the Aurora collection is rich and complete; it offers all the elements necessary to furnish the outdoors in a timeless style.

It -

Bellezza senza tempo e linee romantiche, la collezione Aurora è ricca e completa; propone tutti gli elementi per arredare l'esterno con uno stile intramontabile.

Fr -

La collection Aurora, riche et complète, se caractérise par sa beauté intemporelle et ses lignes romantiques. Elle propose tous les éléments nécessaires pour aménager vos espaces extérieurs et offre un style intemporel.





Luce Collection



En -

Luce collection is created by the encounter of the aluminium frame with the synthetic rope covering armrests and backrest. The collection gets its name from the effects the light plays off the two materials. The tapered legs, slenderer at the bottom, are a feature of the line that confers a sense of lightness to the furnishings, without forfeiting the stability and solidity ensured by the aluminium.

It -

Luce nasce dall'incontro tra l'alluminio della struttura e la corda sintetica che riveste braccioli e schienale. Il nome della collezione si ispira agli effetti luminosi generati dal gioco tra i due materiali. Le gambe rastremate, che tendono ad assottigliarsi all'estremità, sono la peculiarità della linea: conferiscono leggerezza agli arredi senza rinunciare alla stabilità e solidità garantite dall'alluminio.

Fr -

Luce naît de la rencontre entre l'aluminium de la structure et la corde synthétique qui recouvre les accoudoirs et le dossier. Le nom de la collection s'inspire des effets lumineux générés par le jeu entre les deux matériaux. Les pieds effilés, qui ont tendance à s'amincir à l'extrémité, sont la particularité de la ligne : ils donnent de la légèreté au mobilier sans renoncer à la stabilité et solidité garanties par l'aluminium.

En -

Now included in the Luce collection is the new deckchair, a contemporary reinterpretation of the classic sun bed: very lightweight, versatile and comfortable, with a foldable aluminium frame in two colours, graphite and ivory, and a lightly padded, water and sun resistant cover, in the colours brown and ecru.

It -

Entra a far parte della collezione Luce la nuova sdraio, una reinterpretazione contemporanea della classica brandina estiva: leggerissima, versatile e comoda, con una struttura pieghevole in alluminio in due tinte, grafite e avorio, e un telo leggermente imbottito e resistente all'acqua e ai raggi solari, nei colori brown ed écru.

Fr -

Un nouveau transat intègre la collection Luce, une réinterprétation contemporaine du classique lit de camp d'été : très léger, polyvalent et confortable, avec une structure pliable en aluminium et deux couleurs, graphite et ivoire. La toile, légèrement rembourrée et résistante à l'eau et aux rayons du soleil, est dans les couleurs gris/marron et écru.

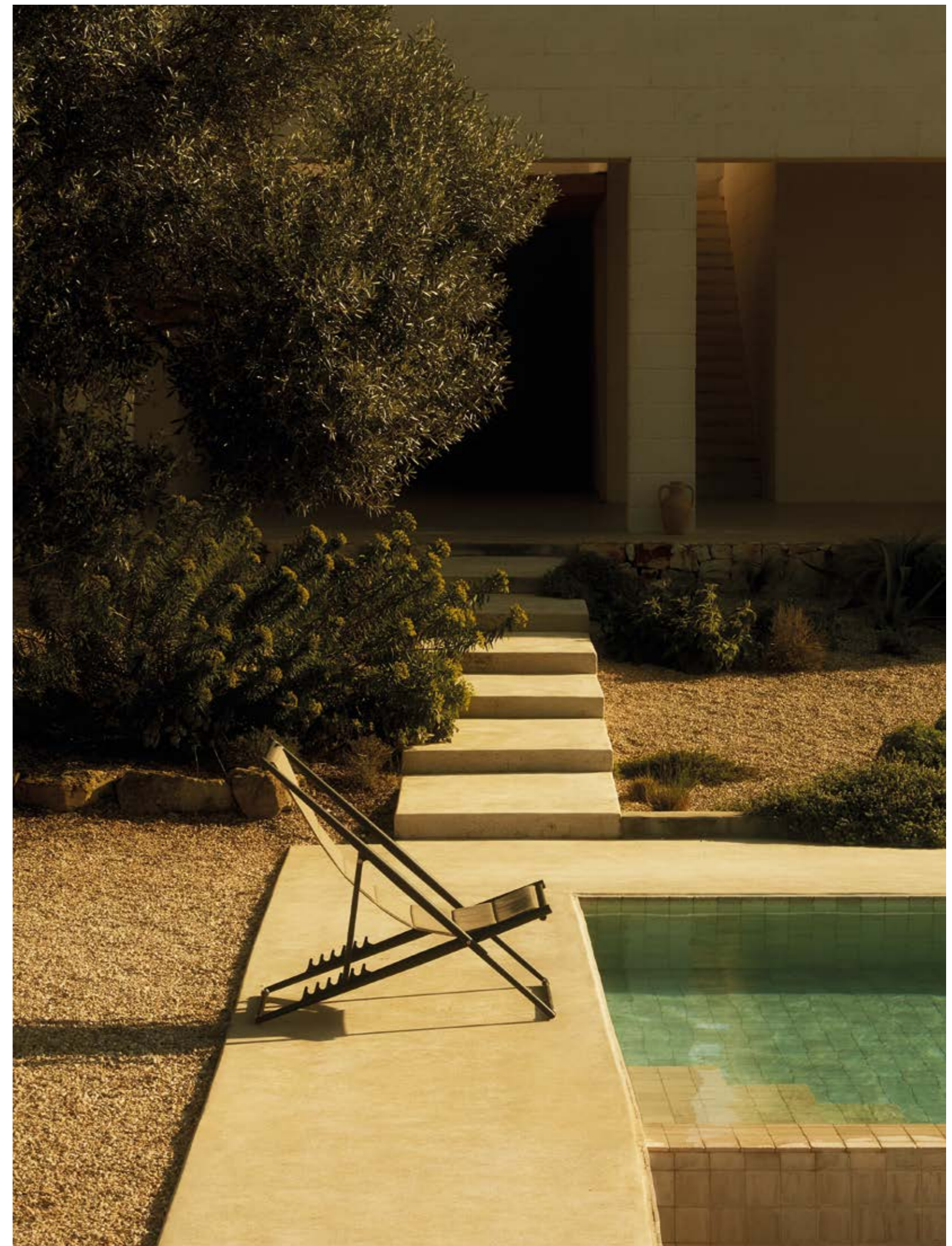



En -

The tables in aluminium are available in round or square shapes.

It -

I tavoli in alluminio sono disponibili nella forma rotonda o quadrata.

Fr -

Les tables en aluminium son disponibles en forme ronde ou carrée.



Ariete Collection

Design by
Adam D. Tihany



En

Designed by Adam D. Tihany, Ariete enhances the primary geometry of the circle as a unique feature through which to reinterpret wrought iron work in a contemporary style. The generously sized collection is handcrafted by skilled craftsmen and includes sofas, armchairs, tables and seating that are ideal for decorating environments with timeless elegance.

It

Disegnata da Adam D. Tihany, Ariete valorizza la geometria primaria del cerchio come tratto peculiare per reinterpretare in chiave contemporanea le lavorazioni in ferro battuto. La collezione dalle proporzioni generose è realizzata a mano da sapienti artigiani, ed include divani, poltrone, tavoli e sedute ideali per arredare gli ambienti con eleganza senza tempo.

Fr

Conçue par Adam D. Tihany, Ariete valorise la géométrie primaire du cercle et en fait un trait distinctif, tout en modernisant les éléments en fer forgé. Les produits de cette collection aux proportions généreuses sont réalisés à la main par des maîtres artisans et comprennent des canapés, un fauteuil, des tables et des sièges, parfaits pour meubler les environnements extérieurs en leur conférant un style élégant et intemporel.



En -

The Ariete collection, designed for contemporary outdoor solutions, stands out for its warm bronze tone and its simple and soft shapes that give a traditional material such as wrought iron a fresh and contemporary style. These features are reflected in the vertical striped pattern of the backrest and the substantial circular shape of the armrests.

It -

La collezione Ariete, pensata per soluzioni outdoor contemporanee, si distingue per la tonalità calda del bronzo e per le sue forme semplici e morbide che conferiscono a una materiale tradizionale come il ferro un'aria fresca e moderna. Queste caratteristiche si riflettono nel pattern a righe verticali dello schienale e nell'ampia forma circolare dei braccioli.

Fr -

La collection Ariete, spécialement conçue pour les solutions outdoor contemporaines, se distingue par sa couleur bronze chaleureuse et ses lignes simples et douces qui confèrent un style jeune et moderne à ce matériau traditionnel qu'est le fer. Ces caractéristiques se retrouvent dans le motif rayé vertical du dossier et dans la forme large et circulaire des accoudoirs.



Panarea Collection



En -

This beach lounger is made in aluminum from a technical fabric that combines the resistance of PVC with the softness of weft made from polyester chenille. Available in graphite and white.

It -

Il lettino è realizzato in alluminio con un tessuto tecnico che unisce la resistenza del PVC alla morbidezza della trama composta da ciniglia di poliestere. Disponibile nei colori grafite e bianco.

Fr -

Le bain de soleil est réalisé en aluminium avec un tissu technique qui unit la résistance du PVC à la douceur de la chenille de polyester que composent la trame. Il est disponible dans les couleurs graphite et blanc.



Conrad Collection



En -

Essential lines and the stability of galvanized iron represent the compositional qualities that make Conrad the best choice for furnishing contract environments and smaller spaces. The texture with small holes is accompanied by square, thin forms, which means the collection has a minimal, contemporary design.

It -

Le linee essenziali e la stabilità del ferro zincato rappresentano le qualità compositive che rendono Conrad la scelta più adatta per arredare ambienti contract e spazi più contenuti. La texture dai piccoli fori si accompagna a forme squadrate e sottili, che conferiscono alla collezione un design minimale e contemporaneo.

Fr -

Grâce à ses lignes sobres et à la stabilité apportée par le fer galvanisé, Conrad est le choix idéal pour aménager les lieux d'accueil et les petits espaces. La texture perforée de petits trous et les formes carrées et fines des différents éléments confèrent à cette collection un design minimal et contemporain.

En -

The discreetly sized stools are available in a high version with or without backrest and in a lower version. The models are easily stackable for ease of movement.

It -

Gli sgabelli dalle proporzioni discrete sono disponibili nella versione alta con o senza schienale e nella versione più bassa. I modelli sono facilmente impilabili per facilitarne lo spostamento.

Fr -

Les tabourets aux proportions discrètes sont disponibles dans la version haute, avec ou sans dossier, et dans la version basse. Les modèles sont facilement empilables pour un déplacement facile.





En -

The extensive collection consists of an extendable rectangular table and chairs with or without armrests, which can be folded and stacked, adapting to different space requirements and making the outdoor environment convivial.

It -

L'ampia collezione si compone di un tavolo rettangolare allungabile e sedie con o senza braccioli, pieghevoli e impilabili, adatta alle differenti esigenze di spazio e rendendo l'ambiente outdoor conviviale.

Fr -

La vaste collection se compose d'une table rectangulaire extensible et de chaises avec ou sans accoudoirs, qui peuvent être pliées et empilées, s'adaptant ainsi aux différentes exigences d'espace et rendant l'environnement extérieur convivial.



Fresbee Collection



En -

With minimalist and simple lines, the new Fresbee coffee table is the perfect combination of functionality and design. The load-bearing frame is available in two versions, teak or graphite-coloured aluminium. The top, with a diameter of 46 cm, made of graphite-coloured aluminium in both cases, is removable and can therefore be used as a tray. The simple and elegant lines of Fresbee, along with the option to choose the base, enable it to integrate easily with the elements of different Unopiù designer collections.

It -

Minimalista ed essenziale nelle linee, il nuovo coffee table Fresbee rappresenta il perfetto connubio tra funzionalità e design. La struttura portante è disponibile in due versioni, teak oppure alluminio color grafite. Il top, del diametro di 46 cm, realizzato in alluminio color grafite in entrambi i casi, è asportabile e può quindi essere usato come vassoio. Le linee semplici ed eleganti di Fresbee, insieme alla possibilità di scelta della base, gli permettono di integrarsi facilmente con gli elementi di diverse collezioni firmate Unopiù.

Fr -

Minimaliste et épurée dans ses lignes, la nouvelle table basse Fresbee représente la combinaison parfaite entre fonctionnalité et design. La structure portante est disponible en deux versions, teak ou aluminium couleur graphite. Le plateau, d'un diamètre de 46 cm, réalisé en aluminium couleur graphite dans les deux cas, est amovible et peut donc être utilisé comme plateau. Les lignes simples et élégantes de Fresbee, ainsi que la possibilité de choisir la base, lui permettent de s'intégrer facilement aux différentes collections signées Unopiù.

Wooden
Collections

02.

Synthesis
Ginger
Amanda
Chelsea
Welcome
Pevero
Swing
Clio
Emy
Titanic
William
C'est La Vie
Cosette

Synthesis Collection



En -

Synthesis is a contemporary collection with an essential design, where the stylish combination of teak and hand-woven WaProLace® synthetic fibre plays a role in enhancing the purity of its lines. Craftsmanship and attention to detail are the identifying features of the many products in the collection.

It -

Synthesis è una collezione contemporanea dal design essenziale: l'elegante connubio tra teak e fibra sintetica WaProLace® intrecciata a mano contribuisce a esaltarne la purezza di linee. Lavorazione artigianale e cura del dettaglio sono tratti identificativi dei molteplici prodotti della collezione.

Fr -

Synthesis est une collection contemporaine au design essentiel : l'élégante combinaison de teck et de fibre synthétique WaProLace® à la main contribue à exalter la pureté des lignes. Le travail artisanal et l'attention donnée aux détails sont des traits distinctifs des nombreux éléments de la collection. une durabilité maximale.





En -
The loungers are adjustable from both sides and designed to meet multiple living needs.

It -
I lettini sono regolabili da entrambi i lati, pensati per rispondere alle molteplici esigenze abitative.

Fr -
Les transats, réglables de chaque côté, sont conçus pour s'adapter aux divers besoins des espaces d'habitation.



En -

Synthesis is characterised by its versatility and ability to adapt to multiple living solutions. Thanks to the use of fine materials and careful workmanship, the collection transforms each room into an elegant, sophisticated and contemporary landscape.

It -

Synthesis si caratterizza per la sua versatilità e capacità di adattarsi a molteplici soluzioni abitative. Attraverso l'uso di materiali pregiati e l'accurata lavorazione la collezione trasforma ciascun ambiente in un paesaggio elegante, sofisticato e contemporaneo.

Fr -

Synthesis se distingue par sa polyvalence et sa capacité à s'adapter à de multiples solutions d'aménagement. Composée de matériaux précieux et se caractérisant par le soin apporté aux détails, cette collection transforme tout type d'environnement en un cadre élégant, raffiné et contemporain.

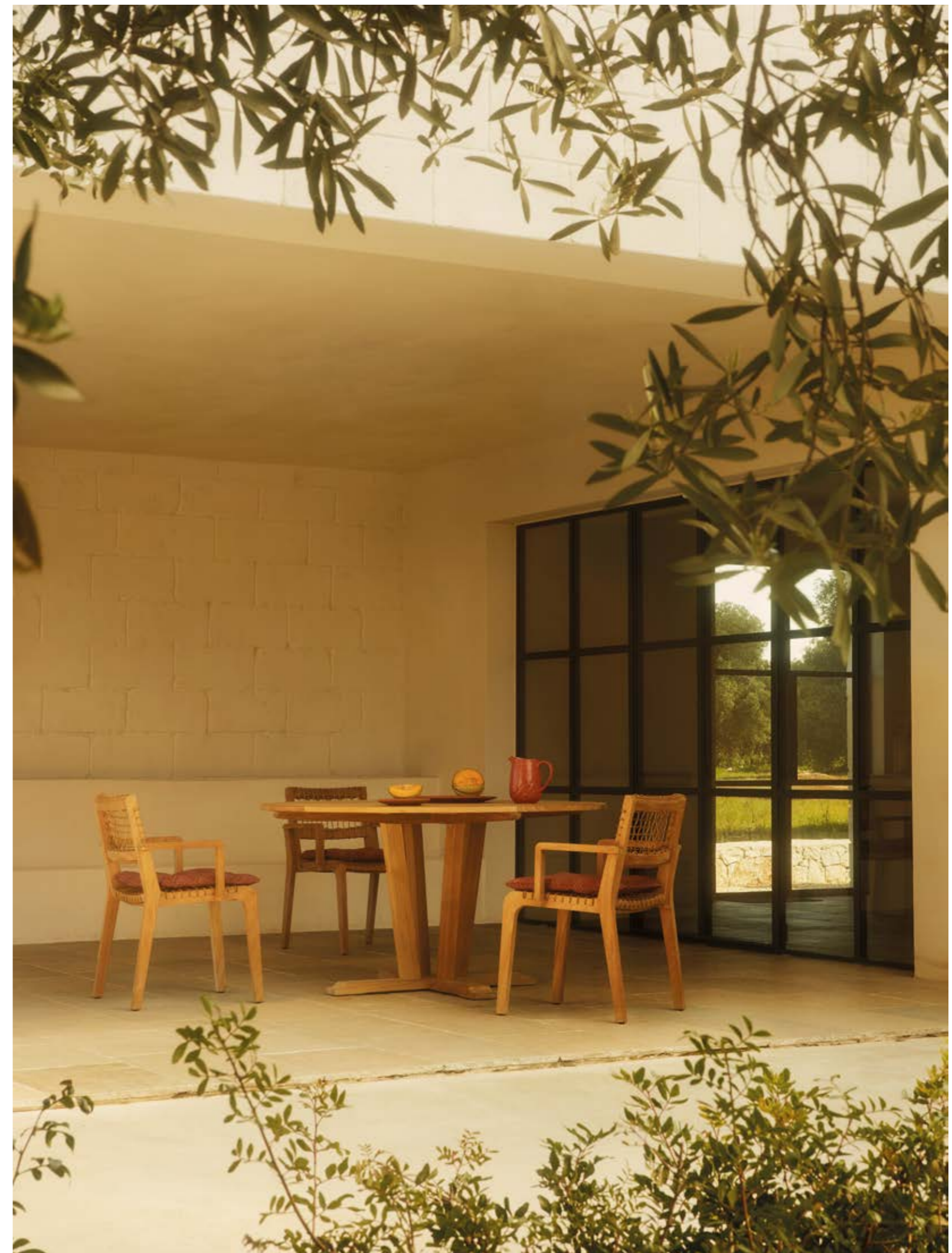

En -

The alcove is a truly welcoming and enveloping environment. Both ends are designed to allow its use to be fully customised. The height is adjustable and can be converted into a comfortable backrest. The curtains design the exterior, filtering the sun and creating continuity between the interior space, the surrounding environment and those inhabiting it.

It -

L'alcova costituisce un vero e proprio ambiente accogliente, e avvolgente. Entrambe le estremità sono pensate per lasciare piena personalizzazione nel suo utilizzo. L'altezza è regolabile e trasformabile in un comodo schienale. Le tende disegnano l'esterno, filtrando il sole e creando un continuo dialogo tra lo spazio interno, l'ambiente circostante e chi lo abita.

Fr -

L'alcôve offre un cadre accueillant et chaleureux. Les deux extrémités sont conçues de manière à permettre une totale personnalisation de son utilisation. La hauteur est réglable en hauteur et permet d'obtenir un dossier confortable. Le voilage protège de l'extérieur, filtrant le soleil et créant un dialogue continu entre l'espace interne, l'environnement et les occupants.





Ginger Collection



En -

Feel like a movie star with the timeless Unopiù director's chair. Ginger is a folding, light and comfortable chair that can be the main character of any decor.

It -

Sentirsi come una star del cinema con l'intramontabile poltroncina da regista di Unopiù. Ginger è una sedia pieghevole, leggera e confortevole che sarà protagonista di qualsiasi tipo di arredo.

Fr -

Se sentir comme une star de cinéma avec l'intemporel fauteuil de réalisateur d'Unopiù. Ginger est une chaise pliante légère et confortable qui sera la star de n'importe quel décor.



En -

The innovative olive green fabric is a hue that has always been part of the brand's representative palette of colors and goes perfectly with the traditional look of the Ginger chair.

It -

L'innovativo telo, di colore verde oliva, è in una tinta che da sempre fa parte della tavolozza di colori rappresentativa del brand e si sposa perfettamente con il look tradizionale della poltroncina Ginger.

Fr -

La toile novatrice est déclinée en vert olive, une nuance qui a toujours fait partie de la palette de couleurs caractéristique de la marque et qui s'associe à la perfection à l'aspect classique du petit fauteuil Ginger.

En -

The canvas, which covers the frame of the teak armchair, is available in different fabrics. The beige-coloured Batyline Serge Ferrari, particularly resistant to salt and chlorinated water, in quilted plastic fabric and classic off-white cotton.

It -

Il telo, che fa da rivestimento alla struttura della poltroncina in teck, è disponibile in diversi tessuti. In Batyline Serge Ferrari di colore beige, particolarmente resistente all'acqua salata e clorata, in tessuto plastico trapuntato e in classico cotone bianco.

Fr -

Le tissu, qui recouvre la structure du fauteuil en teck, est disponible en différents tissus. En Batyline Serge Ferrari de couleur beige, particulièrement résistant au sel et à l'eau chlorée, en tissu plastique matelassé et coton blanc cassé classique.



Amanda Collection



En -

Among the most iconic products of the Unopiù brand, the Amanda hammock harmoniously brings together comfort, design, and excellence of craft. The self-supporting structure in curved laminated wood in shades of walnut effortlessly manages to transform any environment into an elegant personal space, a place to indulge in relaxation.

It -

Tra i prodotti più iconici del brand Unopiù, l'amaca Amanda coniuga armoniosamente comfort, design ed eccellenza artigianale. La struttura autoportante in legno lamellare curvato, nei toni del noce, riesce a trasformare qualsiasi ambiente in un elegante spazio personale, un luogo dove abbandonarsi al relax.

Fr -

Parmi les produits les plus emblématiques de la marque Unopiù, le hamac Amanda allie harmonieusement confort, design et excellence artisanale. La structure autoportante en bois lamellé courbé, dans les tons Noyer, réussit à transformer n'importe quel environnement en un élégant espace personnel, un lieu où s'abandonner à la détente.

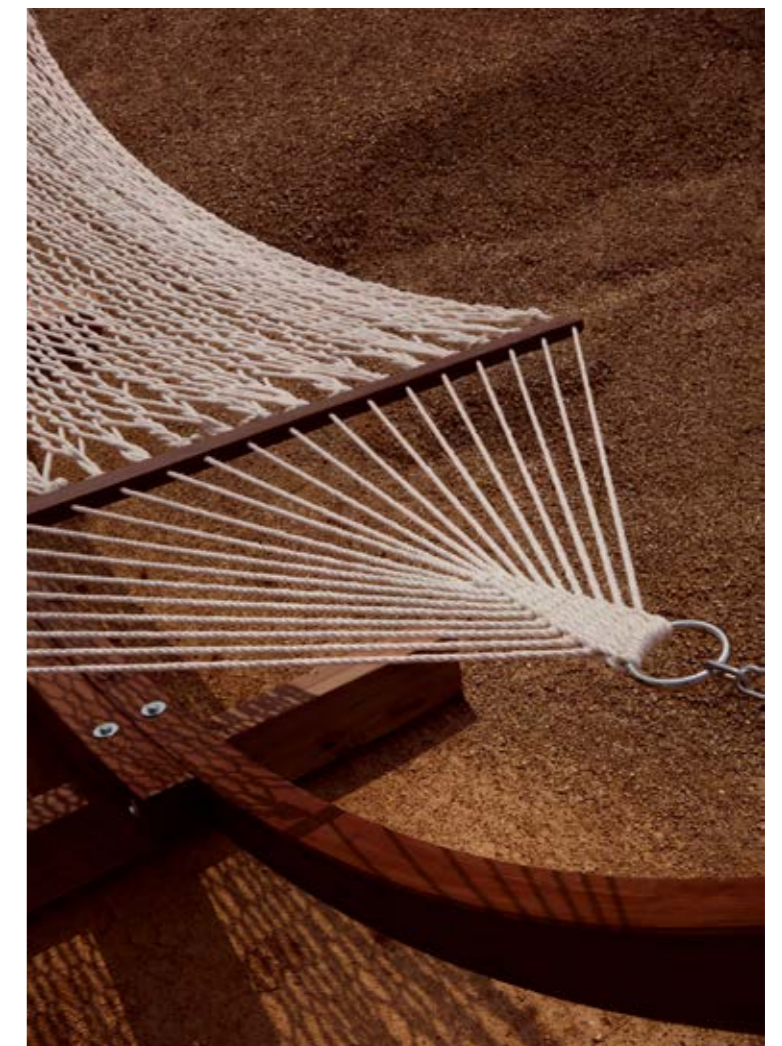

En -

The woven rope net can be either white or in shades of grey and can accommodate up to two people. Comfortable and ideal for a moment's relaxation, it establishes a harmonious dialogue with nature.

It -

La rete dalla corda intrecciata può essere di colore bianco o grigio mélange e permette di ospitare fino a due persone. Confortevole e ideale per un momento di relax, instaurando un armonioso dialogo con la natura.

Fr -

Le filet en corde tressée est proposé en blanc ou gris chiné et permet d'accueillir jusqu'à deux personnes. Confortable et idéal pour profiter d'un moment de détente, il instaure un harmonieux dialogue avec la nature.

Chelsea Collection



En

The Chelsea line is classic and traditional, entirely made of honey-coloured teak, a shade that enhances the naturalness and warmth of the material. This highly articulated collection includes sofas, tables, chairs, loungers and deck chairs, allowing the outdoor space to be transformed into a welcoming, familiar landscape.

It

Chelsea è una linea dal gusto classico e tradizionale, interamente realizzata in teak color miele, tonalità che valorizza la naturalezza ed il calore del materiale. La collezione molto articolata include divani, tavoli, sedute, lettini e sdraio, per permettere di trasformare lo spazio esterno in un paesaggio accogliente e familiare.

Fr

Chelsea est une ligne au style classique et traditionnel entièrement réalisée en teck de couleur miel, une tonalité qui met en valeur l'aspect naturel et chaleureux de ce matériau. Cette collection très structurée inclut des canapés, des tables, des sièges, des transats et des chaises longues et permet de transformer son espace extérieur en un cadre accueillant et intime.





En -

The sofas and armchairs stand out due to their solid shapes and harmonious forms, which enhance the technical and aesthetic characteristics of the teak. The coffee table is characterised by a pattern of elegant horizontal slats, which lighten the compact, basic structure.

It -

I divani e le poltrone si distinguono per le forme dolci e armoniose che esaltano le caratteristiche tecniche ed estetiche del teak. Il tavolino è caratterizzato da una trama di eleganti doghe orizzontali, che alleggeriscono la struttura compatta ed essenziale.

Fr -

Les canapés et les fauteuils présentent des volumes solides et des formes harmonieuses qui exaltent les caractéristiques techniques et esthétiques du teck. La table basse se caractérise par l'élégante trame formée par les lattes horizontales qui allègent la structure compacte et épurée.



En -

The table with horizontal slats is extendable, to allow different sized spaces to be furnished.

It -

Il tavolo dalle doghe orizzontali è allungabile, per permettere di arredare spazi di diverse dimensioni.

Fr -

La table aux lattes horizontales est extensible et permet d'aménager des espaces de différentes dimensions.



En -

The trunk that completes the line: from above and from the front. Made of solid teak with stainless steel hardware, it is essential for storing cushions and objects.

It -

Il baule che completa la linea è realizzato in teak massello con ferramenta in acciaio inox. Fondamentale per riporre cuscini ed oggetti.

Fr -

Le coffre qui complète cette ligne, réalisé en teck massif et doté d'une quincaillerie en acier inoxydable. Il est très pratique pour ranger les coussins et des objets.

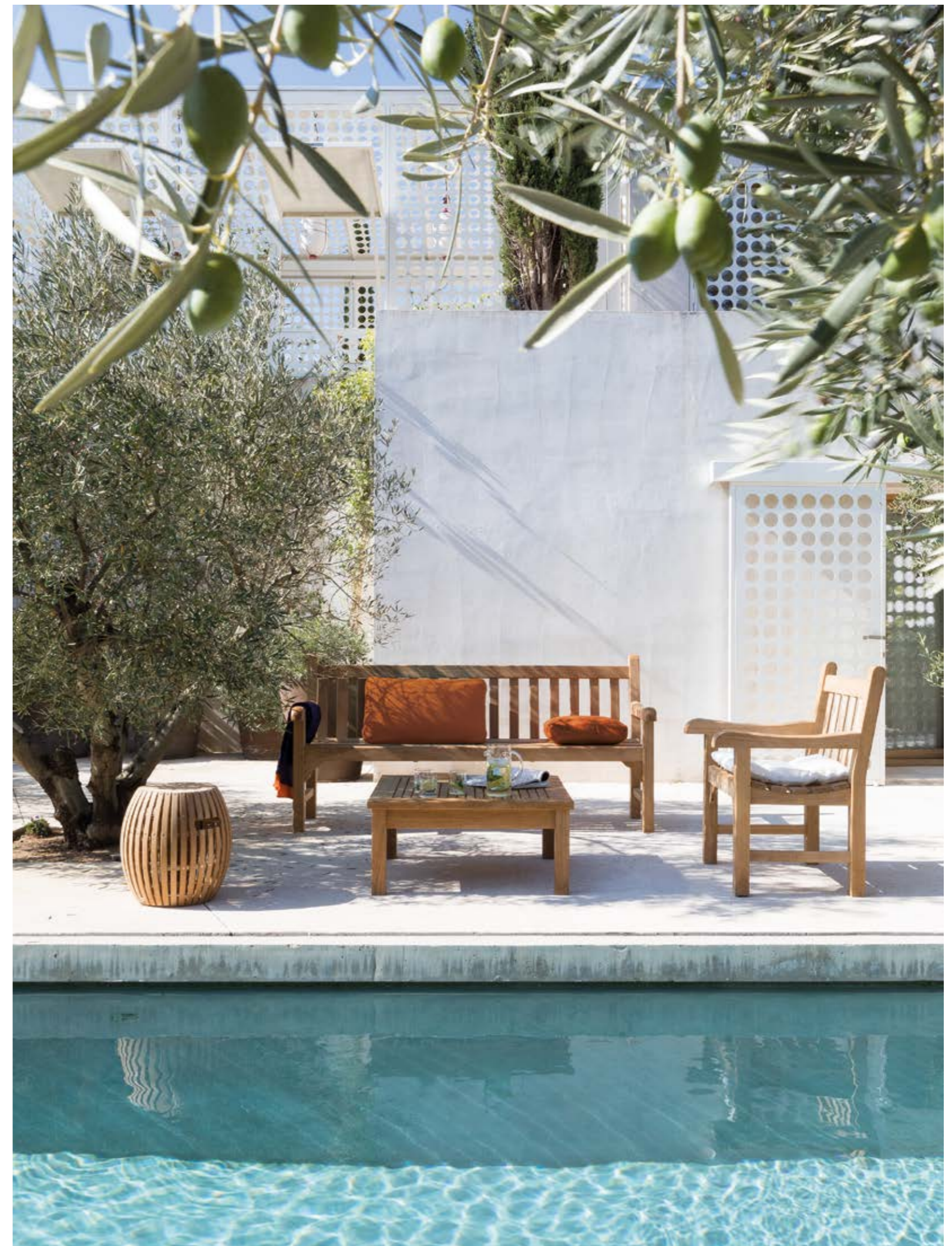

Welcome Collection



En -

An elegant collection with ageless style, the Welcome line is available in two versions, entirely in teak and in teak and rope. The modularity of the furniture allows you to configure areas for relaxation and conviviality, in line with your needs and in harmony with outdoor spaces.

It -

Collezione elegante dallo stile senza età, la linea Welcome è disponibile in due versioni, interamente in teak e in teak e corda. La modularità degli arredi permette di configurare zone di relax e convivialità, in linea con le proprie esigenze e in armonia con gli spazi esterni.

Fr -

Collection élégante au style intemporel, la ligne Welcome se décline en deux versions, entièrement en teck et en teck et corde. La modularité du mobilier permet de configurer des espaces de détente et de convivialité, en fonction de vos besoins et en harmonie avec vos espaces extérieurs.



En -

The line mainly consists of generously proportioned teak sofas mounted on aluminium legs, a detail that adds finesse and personality.

It -

La linea si compone principalmente da divani in teak dalle proporzioni generose montati su piedi in alluminio, dettaglio che aggiunge preziosità e personalità.

Fr -

Cette ligne se compose principalement de canapés en teck aux dimensions généreuses montés sur pieds en aluminium, un détail qui ajoute une touche de raffinement et de caractère.







Pevero Collection

En

Pevero is an excellent example of Unopiù's expertise in working teak, a precious material with exceptional technical characteristics. This extensive and versatile collection is characterized by the geometric nature of its frames and the craftsmanship of its interlocking wooden joints, inspired by the oriental culture and enhanced by the natural finish of the wood, which follows the lines and enhances the stylish details.

It

Pevero è un eccellente esempio dell'expertise di Unopiù nella lavorazione del teak, materiale pregiato dalle ottime caratteristiche tecniche. La collezione, ampia e versatile, è contraddistinta dalla geometria dei telai e dalle lavorazioni a incastro ispirate al mondo orientale e valorizzate dalla finitura naturale del legno, che segue le linee e ne esalta i dettagli formali.

Fr

Pevero est un excellent exemple de l'expertise d'Unopiù dans le travail du teck, matériau précieux aux excellentes caractéristiques techniques. La collection, vaste et polyvalente, se caractérise par la géométrie des cadres et par les usinages à emboîtement inspirés du monde oriental et mis en valeur par la finition naturelle du bois, qui suit les lignes et exalte les détails formels.





En -

The white textilene sunlounger cover elegantly completes the adjustable structure. The armchair features intertwined polypropylene yarn rope with a soft, natural colour, and a cross-section of teak wood members.

It -

Il telo del lettino in textilene bianco completa con eleganza la struttura regolabile. La poltroncina si contraddistingue per l'intreccio in corda dal colore tenue e naturale, e per le assi in legno di teak dalla lavorazione a sezione circolare.

Fr -

La toile du lit en textilène blanc, complète avec élégance la structure réglable. Le petit fauteuil se caractérise par l'entrelacement de la corde par le polypropylène d'une couleur douce et naturelle et par les lattes en bois de teck à section ronde.





Swing Collection



En -

Soft, elegant lines and an ergonomic shape make Swing collection ideal for moments of relaxation. The skillful crafting of thermo-curved teak wood slats gives sinuous and welcoming look to the elements of the Swing line.

It -

Linee elegantemente morbide e forma ergonomica rendono la collezione Swing ideale per momenti di relax. La sapiente lavorazione dei listelli in legno di teak termo-curvato dona un aspetto sinuoso e accogliente agli elementi della linea Swing.

Fr -

Des lignes élégamment douces et une forme ergonomique rendent la collection Swing idéale pour des moments de détente. Le travail habile des lattes en bois de teck thermo-courbé donne un aspect sinueux et accueillant aux éléments de la ligne Swing.





En -

The chaise-longue, with its soft lines and ergonomic shape, is ideal for moments of relaxation. Swing has a stainless-steel accessory, which supports and raises the structure from the ground, giving it a light, comfortable feel.

It -

La chaise-longue dalle linee dolci e dalla forma ergonomica è ideale per momenti di relax. Swing dispone di un accessorio in acciaio inox, che supporta e rialza da terra la struttura, conferendole un'aria leggera e confortevole.

Fr -

La chaise-longue, qui offre des lignes douces et une forme ergonomique, est idéale pour les moments de relaxation. Swing dispose d'un accessoire en acier inoxydable, qui soutient et surélève la structure en lui conférant un style léger et confortable.





Clio Collection

En -

The subtle, classic elegance of Clio, the folding teak deckchair, brings to mind sophisticated atmospheres, chic and slightly retro – the decking of very exclusive swimming pool and spas, the deck of a cruise ship, Mediterranean promenades, any outdoor relaxation area.

It -

La sottile, classica raffinatezza di Clio, sdraio pieghevole in teak, porta alla mente atmosfere sofisticate, chic e un po' retrò – il bordo di piscine e terme molto esclusive, il ponte di una nave da crociera, in lungomare del Mediterraneo, qualsiasi area di relax all'aperto.

Fr -

Le raffinement subtil et classique de Clio, transat pliant en teck, évoque des ambiances sophistiquées, chics et légèrement rétro - le bord des piscines et des spas très exclusifs, le pont d'un bateau de croisière, un front de mer méditerranéen, tout espace de détente en plein air.



En
The 100% cotton fabric is fitted with a handy pocket for a pillow.

It
Il telo in cotone è dotato di una pratica apertura dove è possibile inserire un cuscino.

Fr
La toile en coton est dotée d'une ouverture pratique où il est possible d'y insérer un coussin.

Emy Collection



En

Timeless elegance and comfort describe the Emy folding armchair, inspired by the classic Tripoline, brought to fame in the 19th century by English officers who made use of it on safaris and military campaigns. The seat with large pockets rests on a honey-colored teak structure, equipped with an ingenious mechanism that allows it to be closed.

It

Eleganza e praticità senza tempo per la poltroncina pieghevole Emy, ispirata alla classica Tripolina, resa celebre dagli ufficiali Inglesi che la utilizzavano nei safari e nelle campagne militari del XIX secolo. La seduta con grosse tasche appoggia su gambe in teak, dotate di un ingegnoso meccanismo che ne permette la chiusura.

Fr

Élégance intemporelle et praticité pour le fauteuil pliant Emy, inspiré du fauteuil classique Tripolina, rendu célèbre par les officiers britanniques qui l'utilisaient lors des safaris et des campagnes militaires au XIXe siècle. Le siège, doté de grandes poches, repose sur des pieds en teck, dotés d'un ingénieux mécanisme qui permet de le fermer, ce qui le rend particulièrement adapté aux environnements extérieurs.

En -

The folding armchair, inspired by the famous Tripolina, is characterised by the careful finish of the leather upholstery, which makes it ideal for indoor environments.

It -

La poltroncina pieghevole, ispirata alla celebre Tripolina, si contraddistingue per l'attenta lavorazione del rivestimento in pelle, che la rende ideale per ambienti indoor.

Fr -

Le fauteuil pliant, inspiré du célèbre fauteuil Tripolina, se distingue par la finition soignée de son revêtement en cuir, qui en fait un meuble idéal pour les espaces intérieurs.





Titanic Collection

En -

Inspired by century-old deckchairs typical of the first luxury ocean liners, the Titanic chaise longue in teak and brass is foldable, adjustable in three positions and equipped with a removable footrest.

It -

Ispirata al design d'antan delle sdraio da ponte apparse sui primi transatlantici da crociera, la chaise longue Titanic, in teak e ottone, è pieghevole, regolabile in tre posizioni ed è dotata di un poggiatesta amovibile.

Fr -

Inspirée du design désuet des chaises longues apparues sur les premiers paquebots de croisière, la chaise longue Titanic, en teck et laiton, est pliable, réglable en trois positions et dotée d'un repose-pied amovible.



En -

The Chaise longue has a removable footrest. The reclining backrest, enriched by a soft cushion, offers a special kind of comfort. Its traditional lines lend it an air of timelessness.

It -

La Chaise longue è composta dal poggiatesta amovibile. Lo schienale reclinabile arricchito dal soffice cuscino offre un comfort speciale. Le sue linee tradizionali la rendono un pezzo dal sapore senza tempo.

Fr -

La chaise longue est composée d'un repose-pied amovible. Le dossier inclinable orné d'un coussin moelleux offre un confort inimitable. Ses lignes classiques en font un meuble au style intemporel.



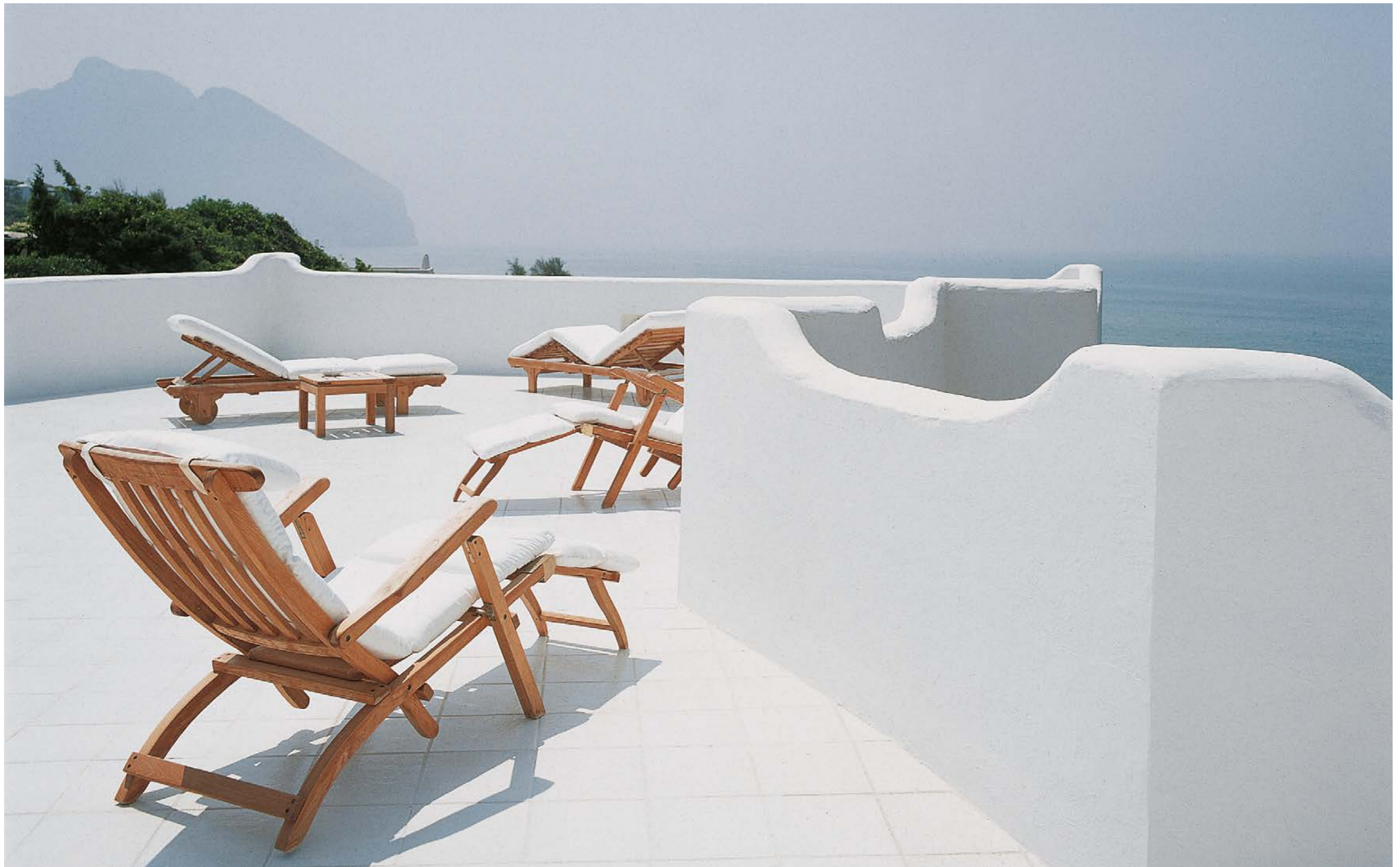

William Collection



En -

Using tradition as a reference point, the William chair enhances the sinuous variations typical of teak wood, creating refined and timeless atmospheres. Folding chair made from the original "Viken" design of Madame G. Norin.

It -

Facendo della tradizione il suo riferimento, la sedia William valorizza le sinuose declinazioni proprie del legno di teak, creando atmosfere raffinate e senza tempo. Realizzata su disegno originale "Viken" di Madame G. Norin.

Fr -

Faisant de la tradition sa référence, la chaise William met en valeur les déclinaisons sinueuses propres au bois de teck, en créant des atmosphères raffinées et intemporelles. Le modèle original "Viken" a été dessiné par Madame G. Norin.



En -
The seat and backrest
of the folding chair are
characterised by the
traditional pattern of vertical
and horizontal slats.

It -
Seduta e schienale
della sedia pieghevole
sono caratterizzate dalla
tradizionale trama a doghe
orizzontali e verticali.

Fr -
L'assise et le dossier de
la chaise pliante présentent
une trame traditionnelle
à lattes verticales
et horizontales.





C'est La Vie Collection

Design by
Michele Bönan

En

Designed by Michele Bönan, the C'est La Vie collection stands out due to its construction in precious polished sapelli mahogany, a material that lends elegance, solidity and harmony to each element. Polishing enhances its lines, making the material pleasant to the touch and generating an alluring complicity between the piece of furniture and the reflections of the natural environment.

It

Disegnata da Michele Bönan, C'est La Vie è una collezione che si distingue per la sua realizzazione in pregiato legno di mogano Sapelli lucidato, materiale che conferisce eleganza, solidità ed armoniosità a ciascun elemento che la compone. La lucidatura esalta le sue linee, rendendo il materiale piacevole al tatto e generando un affascinante dialogo tra il mobile e i riflessi dell'ambiente naturale.

Fr

Conçue par Michele Bönan, C'est La Vie est une collection qui se distingue par l'utilisation de bois précieux d'acajou Sapelli poli, un matériau qui confère un style élégant et harmonieux ainsi qu'une grande robustesse à tous les éléments qui la composent. Les lignes sont mises en valeur par la brillance du bois, un matériau agréable au toucher qui permet de créer un dialogue fascinant entre le mobilier et les reflets de l'environnement naturel.

En -

The natural veins draw delicate motifs that complement the geometric lines of the collection, giving the furnishings a timeless class.

It -

Le venature naturali disegnano motivi delicati che completano le linee geometriche della collezione, donando agli arredi una classe senza tempo.

Fr -

Les veinures naturelles dessinent des motifs délicats qui viennent enrichir les lignes géométriques de cette collection et qui lui confère un style luxueux intemporel.





En -

The collection stands out due to its careful attention to every little detail: from the removable table tops and loungers with adjustable backrests, to the polished stainless-steel legs that decorate and enrich each element.

It -

La collezione si distingue per la cura attenta a ciascun minimo dettaglio: dai piani estraibili del tavolo e lettini con lo schienale regolabile, sino ai piedini in acciaio inossidabile lucido che decorano e arricchiscono ogni elemento.

Fr -

Cette collection se caractérise par le soin minutieux apporté au moindre détail, des plateaux de table coulissants aux transats au dossier réglable et aux pieds en acier inoxydable brillant, qui décorent et mettent en valeur chaque élément.



Cosette Collection



En -

The collection consists of an extendable rectangular table, a deck chair and folding armchairs, available in both aluminium and teak with a cover in dove grey synthetic fabric or in white hemp and soft grey technical fabric. Both choices guarantee maximum durability and weather resistance.

It -

La collezione si compone di un tavolo rettangolare allungabile, uno sdraio e poltroncine pieghevoli, disponibili sia in alluminio che in teak con rivestimento in tessuto sintetico color tortora o in tessuto tecnico bianco canapa e grigio tenue. Entrambe le scelte garantiscono massima durabilità e resistenza agli agenti atmosferici.

Fr -

La collection se compose d'une table rectangulaire extensible, un transat et des fauteuils pliants, disponibles en aluminium ou en teck avec revêtement en tissu synthétique couleur tourterelle ou en tissu technique blanc chanvre et gris tendre. Les deux choix garantissent une durabilité et une résistance maximales aux agents atmosphériques.



En -

Lightweight and versatile, the small armchairs combine the warmth of teak and the practicality of technical fabric with solid and precious materials.

It -

Leggere e versatili, le sedie abbinano il calore del teak e la praticità del tessuto tecnico con materiali solidi e pregiati.

Fr -

Légers et polyvalents, les petits fauteuils allient la chaleur du teck et la praticité du tissu technique avec des matériaux solides et précieux.



Fibre
Collections

Agorá
Experience
Nacre
Olimpia
Capri

03.

Agorà Collection



En -

Agorà stands out due to its soft, organic forms. The rounded, enveloping character found in each product in the collection expresses a sense of comfort. The aluminium frame is as light as it is sturdy and its combination with the fibre, which is resistant to any atmospheric agent, gives it a sense of timelessness.

It -

Agorà si distingue per le sue forme morbide ed organiche. Il carattere tondeggiante e avvolgente ricorre in ciascun prodotto della collezione esprimendo un senso di comfort. La struttura in alluminio è tanto leggera quanto robusta e la combinazione con la fibra, resistente a tutti gli agenti atmosferici, le conferisce un sapore senza tempo.

Fr -

Agorà se distingue par ses formes souples et naturelles. La rondeur et la douceur se retrouvent dans tous les éléments de la collection et lui confèrent un style douillet et confortable. La structure en aluminium, aussi légère que robuste, se combine à la fibre, qui résiste à tous les agents atmosphériques, et confère un style intemporel.





En ~

Agorà consists of versatile, modular furnishings that allow the creation of linear and L-shaped configurations and linear sofas, customising outdoor spaces according to any need.

It ~

Agorà si compone di arredi versatili e modulari che permettono di creare configurazioni lineari ed a L, personalizzando gli spazi esterni in base a ogni esigenza.

Fr ~

Agorà se compose de meubles polyvalents et modulaires qui permettent de créer des configurations linéaires et de personnaliser les espaces extérieurs en fonction des diverses exigences.

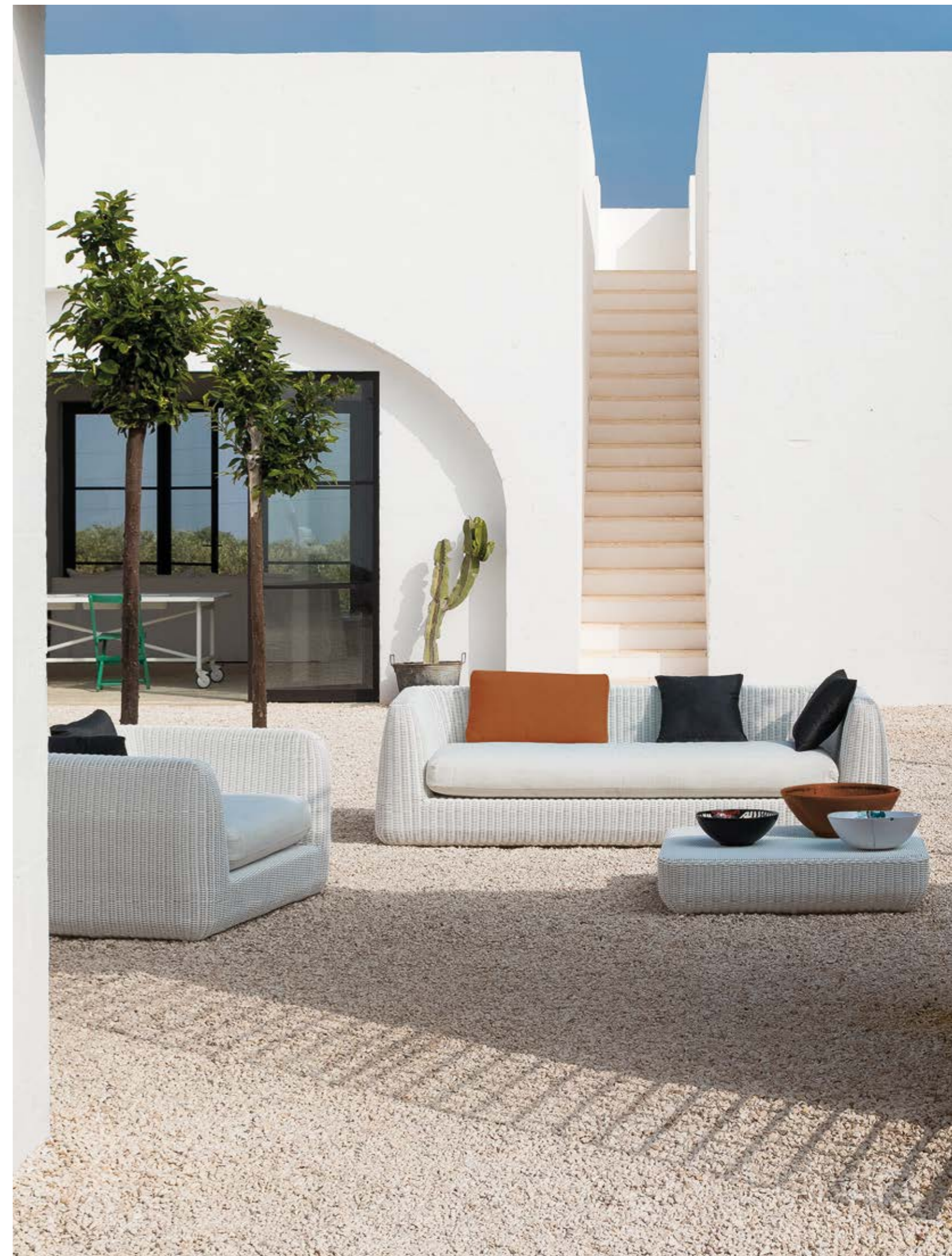

En -

The collection is features pleasant-to-the-touch material interweaving, applied with versatility to the various accessories.

It -

La collezione è contraddistinta dall'intreccio materico piacevole al tatto, applicato con versatilità ai diversi complementi.

Fr -

Cette collection se caractérise par le tressage naturel agréable au toucher, qui se retrouve sur les divers éléments complémentaires.





Experience Collection



En

This monochromatic collection is characterized by the coming together of graphite-colored aluminum and expertly hand woven WaProLace® fibre.

It

La collezione monocromatica è caratterizzata dall'accostamento di alluminio color grafite e fibra sintetica WaProLace®, sapientemente tessuta a mano.

Fr

La collection monochrome se caractérise par la combinaison de l'aluminium graphite et de la fibre synthétique WaProLace®, savamment tissée à la main.



En -
The light, slender structure
mixed with the craftsmanship
of the weave make
Experience an elegant,
sophisticated line.

It -
La struttura leggera
e slanciata mescolata
all'artigianalità dell'intreccio,
rendono Experience una
linea elegante e raffinata.

Fr -
La structure légère et
élancée et le tressage
de style artisanal apportent
une touche élégante et
raffinée à la ligne Experience.



En -

The backrest and the seat of the armchair made of hand-woven WaProLace® fibre have softer, more rounded shapes, while the curved backrest, in particular, confers comfort and harmony.

It -

Lo schienale e la seduta della poltroncina in fibra WaProLace® intrecciata a mano, si distinguono per forme più morbide e circolari, in particolare lo schienale curvilineo conferisce comfort ed armonia.

Fr -

Le dossier et l'assise du fauteuil en fibre WaProLace® tissée à la main se distinguent par des formes plus douces et plus circulaires, en particulier le dossier incurvé lui confère confort et harmonie.





Nacre Collection

En

Perfect for chilling out, relaxing and socialising. Inspired by the French term "nacre", meaning mother of pearl, this armchair features soft lines of the profile and rounded shapes reminiscent of a shell. The conical truncated legs, made of graphite-coloured aluminium, give it stability and lightness. The seat is wrapped in a recyclable WaProLace® synthetic fibre rope, in a warm antique brown colour, which gives it a refined feel.

It

Chillout, rilassante e conviviale. Ispirata al significato del termine francese "nacre", ossia madreperla, Nacre è una poltroncina che si caratterizza per le linee morbide del profilo e le forme tondeggianti che richiamano una conchiglia. Le gambe a tronco conico, realizzate in alluminio color grafite, conferiscono stabilità e leggerezza al prodotto. La seduta è avvolta da una corda in fibra sintetica WaProLace® riciclabile, dal caldo colore antique brown, che le dona un tocco ricercato.

Fr

Chillout, délassante et conviviale. Prenant pour source d'inspiration le sens du terme français «nacre», cette chaise de jardin arbore lignes douces et formes arrondies qui évoquent un coquillage. Les pieds coniques, réalisés en aluminium de couleur graphite, sont un emblème de stabilité et de légèreté. L'assise est enveloppée par une corde de fibres synthétiques recyclables WaProLace® de couleur antique brown, qui lui apporte une touche raffinée.

Olimpia Collection



En -

The collection revisits Mediterranean traditional aesthetic criteria. Supple, sinuous shapes characterize all the elements in this collection, its distinctive feature being the hand-woven weave of WaProLace® synthetic fibre. This elegant pattern covers up the aluminum frame, enhancing its voluptuous, enveloping contours.

It -

La collezione nasce come rivisitazione delle linee tradizionali mediterranee. Le forme dolci e sinuose ricorrono in tutti gli elementi della serie, il cui tratto caratteristico è l'intreccio a mano in fibra sintetica WaProLace®. La trama elegante ricopre interamente la struttura in alluminio, valorizzandone i volumi lussuosi e avvolgenti.

Fr -

La collection est née comme une réinterprétation des lignes traditionnelles méditerranéennes. Les formes douces et sinueuses se retrouvent dans tous les éléments de la série, dont le trait caractéristique est le tressage à la main en fibre synthétique WaProLace®. La trame élégante recouvre entièrement la structure en aluminium, mettant ainsi en valeur les volumes voluptueux et enveloppants.



Capri Collection



En -

Colourful and comfortable, Capri is a collection of armchairs made from WaProLace® synthetic fibre, skilfully hand-woven by decorator craftsmen, with aluminium tubing. It is practical, light and versatile, while the stonewashed fibre recreates an evocative atmosphere with a retro feel.

It -

Colorata e confortevole, Capri è una collezione di poltroncine in fibra sintetica WaProLace®, sapientemente intrecciata a mano da artigiani decoratori, con tubolare in alluminio. È pratica, leggera e versatile, la fibra delavée ricrea una suggestiva atmosfera dal gusto rétro.

Fr -

Colorée et confortable, Capri est une collection de fauteuils en fibre synthétique WaProLace® soigneusement tressée à la main par des artisans décorateurs à l'aide de tubes en aluminium. Pratique, légère et polyvalente, la fibre délavée crée une ambiance pittoresque au style rétro.



Sunshades

04.

Shibuya
Tibisco
Solaire
Lipari
Salento
Damian
Orangerie
Manta
Nagi
Levante
Covercar
Dafne



Shibuya® Collection

Design by
Ferruccio Laviani

En

Designed by Ferruccio Laviani, Shibuya is the first mobile pergola introducing the concept of dynamism, thus revolutionizing the static architectural canons of traditional structures. The aluminum structure is available as a unit that can be secured to the ground. Otherwise, Shibuya can be fitted with four locking wheels for maximum freedom of movement.

It

Disegnata da Ferruccio Laviani, la pergola mobile Shibuya è stata la prima a introdurre il concetto di dinamismo, rivoluzionando il principio architettonico di staticità delle strutture tradizionali. La struttura in alluminio è disponibile come unità fissa da ancorare al suolo; in alternativa, la si può fissare su quattro ruote con blocco, per dare la massima libertà di movimento.

Fr

Dessinée par Ferruccio Laviani, la pergola mobile Shibuya a été la première à introduire le concept de dynamisme, révolutionnant le principe architectural des structures traditionnelles statiques. La structure en aluminium est disponible comme unité fixe à ancrer au sol; alternativement, elle peut être fixée sur quatre roues avec blocage, pour donner une liberté maximale de mouvement.





En ~

Free-standing or wall-mounted, the pergola is completed by different types of roofs, which guarantee excellent shelter from the sun, designing light, elegant shadows in the environment.

It ~

Autoportante o addossata, la pergola si completa con diverse tipologie di coperture, che garantiscono un ottimo riparo dal sole, disegnando ombre leggere ed eleganti nell'ambiente.

Fr ~

Autoportante ou adossée, la pergola peut être complétée de divers types de couvertures offrant une protection optimale contre le soleil et créant des ombres légères et élégantes dans l'environnement.

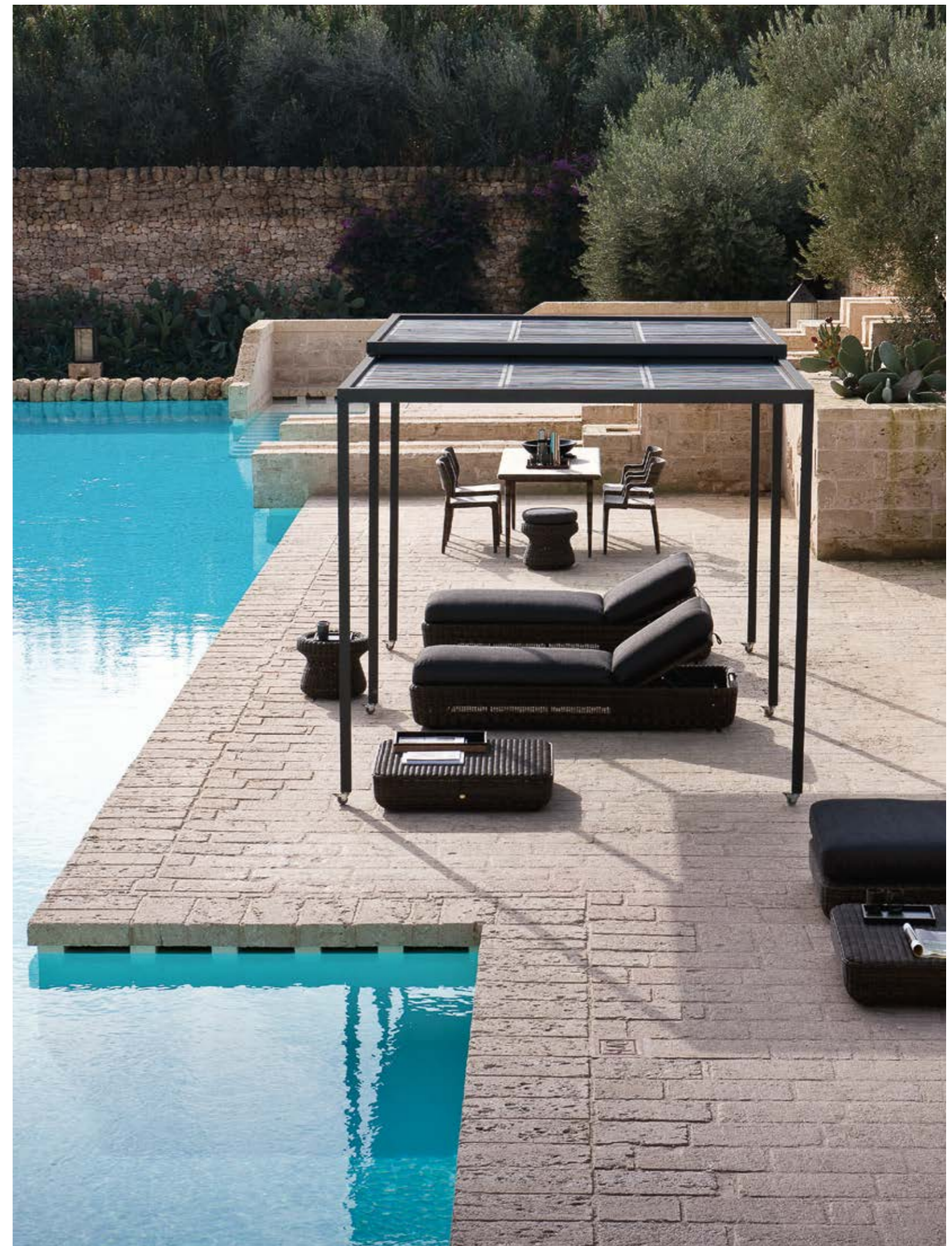



Tibisco Collection

En

Tibisco reinterprets the historic structures found in ancient Cistercian monasteries, offering a line of pergolas in a classic, traditional style. The romantic, ornamental style is conveyed by the circular patterns of the front beams, which interact harmoniously with the slim, delicate structure made from powder-coated galvanised iron.

It

Tibisco reinterpreta le storiche strutture presenti negli antichi monasteri cistercensi, proponendo una linea di pergole dallo stile classico e tradizionale. Il sapore romantico e ornamentale si distingue nei motivi circolari delle travi frontali, che dialogano armoniosamente con la struttura sottile e delicata in ferro zincato verniciato a polveri.

Fr

Tibisco réinterprète les structures historiques présentes dans les anciens monastères cisterciens et propose une ligne de pergolas au style classique et traditionnel. Le style romantique et ornemental se distingue par ses motifs circulaires des traves frontales qui complètent harmonieusement la structure fine et délicate en fer galvanisé peint revêtu de poudre.



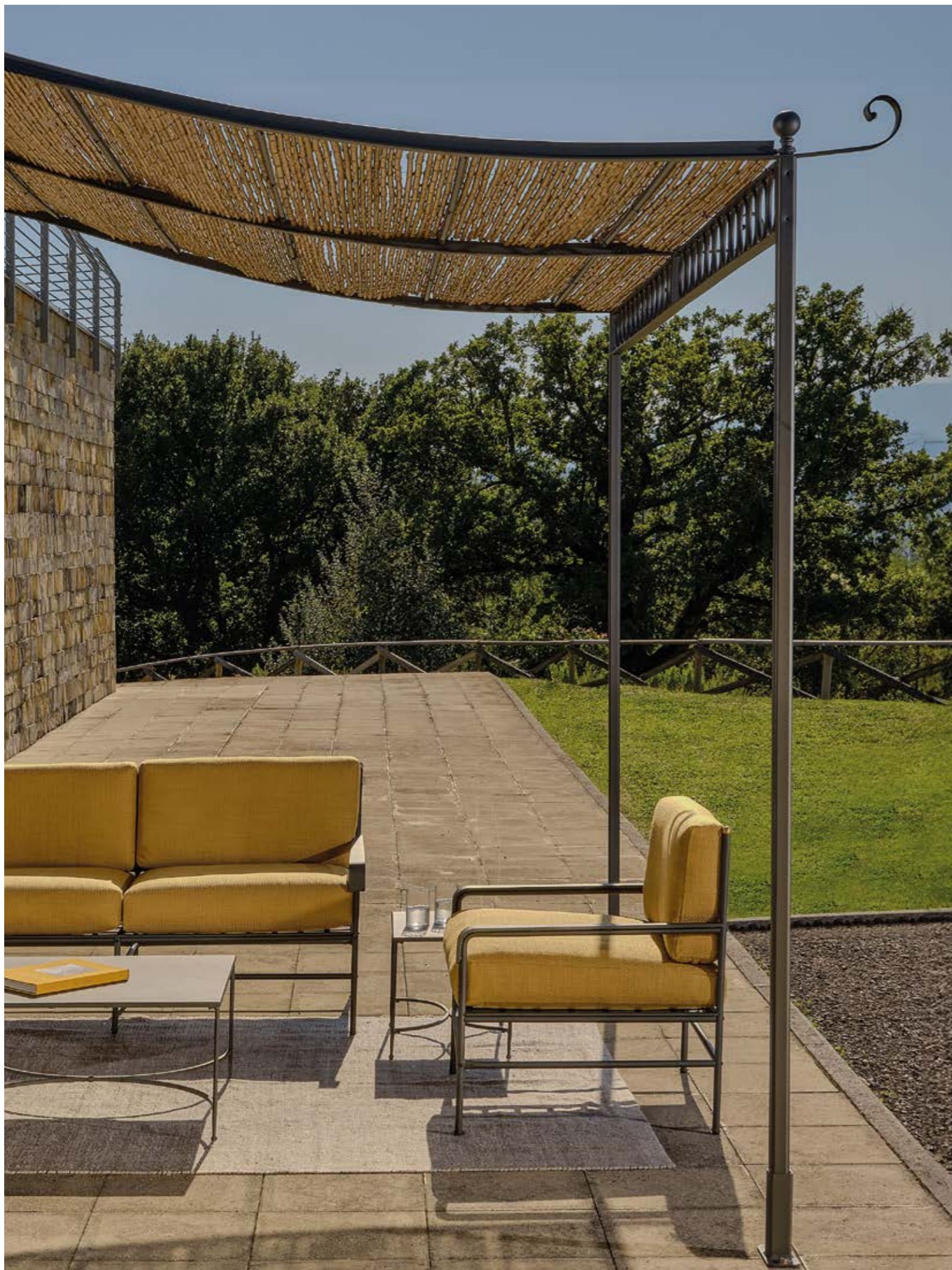

En -

Available lean-to, self-supporting and in the form pavilion form, the collection can be complemented with decorations and semicircles in the plinths, to add details of style and timeless elegance.

It -

Disponibile addossata, autoportante e sottoforma di padiglione, la collezione può essere integrata con decori e semicerchi nei basamenti, per aggiungere dettagli di stile ed eleganza senza tempo.

Fr -

Disponibles en version autoportante sous forme de pavillon et adossée, les pergolas d'arceaux et bases décorées pour ajouter des détails de style et d'élégance intemporelle.

Solaire Collection



En

The Solaire pergola collection stands out due to its traditional, ornamental style, which is reminiscent of the classical lines of historic Italian garden architecture. Its characteristics make it an intermediate indoor/outdoor complement suited to every home, with which it generates a harmonious dialogue. Its timeless style makes it the ideal complement to the historic Unopiù lines.

It

La collezione di pergole Solaire si distingue per il sapore tradizionale ed ornamentale, che richiama lo stile classico delle storiche architetture dei giardini all'italiana. La sua funzione la rende un complemento intermedio tra interno ed esterno necessario per ciascuna abitazione, con cui genera un armonioso dialogo. Il suo stile senza tempo la rende il completamento ideale delle storiche linee di Unopiù.

Fr

La collection de pergolas Solaire se distingue par son caractère traditionnel et ornemental qui rappelle le style classique des architectures historiques des jardins à l'italienne. La pergola est un élément intermédiaire entre l'extérieur et l'intérieur de la maison, avec laquelle elle instaure un dialogue harmonieux. Son style intemporel en fait un complément idéal des lignes historiques d'Unopiù.



En -

The solid frame in powder-coated galvanised iron becomes a decorative element and is available on all models: wall-mounted, free-standing or in the form of a pavilion with a round or octagonal floorplan. The many coverings, available in various finishes, adapt to all the different types, completing the product with sophistication and elegance.

It -

Lo scheletro solido in ferro zincato verniciato a polveri diventa elemento decorativo ed è disponibile in tutti i modelli: addossata, autoportante e sotto forma di padiglione a pianta rotonda o ottagonale. Le molteplici coperture, disponibili in diverse finiture si adattano a tutte le tipologie, completando con raffinatezza ed eleganza il prodotto.

Fr -

La structure solide en fer galvanisé peint revêtu de poudre devient un élément décoratif. Il est disponible dans tous les modèles : adossée, autoportante et sous forme de pavillon rond ou octogonal. Les couvertures, proposées avec diverses finitions, s'adaptent à tous les types de structure et y apportent une touche de raffinement et d'élégance.



Lipari Collection



En -

The Lipari parasol collection is designed to complete and customize outdoor spaces by combining practicality and functionality with elegant aesthetics. The fabric covering, available in various colors, is water-repellent and resistant to fading caused by U.V. rays. Available in various sizes and finishes, Lipari allows the utmost freedom to create and choose the best solution.

General catalogue

It -

Una collezione di ombrelloni pensata per completare e personalizzare gli spazi esterni, coniugando praticità e funzionalità a un'elegante estetica. Il telo in tessuto è idrorepellente e resistente allo sbiadimento dovuto all'azione dei raggi U.V. Disponibile in numerose dimensioni e finiture, la linea Lipari lascia la massima libertà di comporre e scegliere la soluzione migliore, in base alle proprie esigenze.

Fr -

Une collection de parasols conçue pour compléter et personnaliser les espaces extérieurs, alliant praticité et fonctionnalité à une esthétique élégante. La toile en tissu acrylique est hydrofuge et résistante à la décoloration due à l'action des rayons U.V. Disponible dans de nombreuses dimensions et finitions, la ligne Lipari laisse la plus grande liberté pour composer et choisir la meilleure solution en fonction de vos besoins.

235



En -

The materials range from ash wood to the central pole made from beech or aluminum, the base made from stone, stainless-steel or galvanized iron, right up to a circular base made from concrete and an adjustable iroko wood top, designed by Studio Adolini.

It -

I materiali variano dal legno di frassino o di faggio, all'alluminio per il palo centrale, alla base in pietra, acciaio inox o ferro zincato fino ad una base circolare con struttura in cemento e ripiano in legno di iroko regolabile, disegnata dallo Studio Adolini.

Fr -

Les matériaux utilisés sont très variés. On peut y trouver un mât central en bois de frêne, ou en aluminium, un socle en pierre, ou en fer galvanisé, et une base circulaire en béton dotée d'une étagère en bois d'iroko réglable, conçue par Studio Adolini.

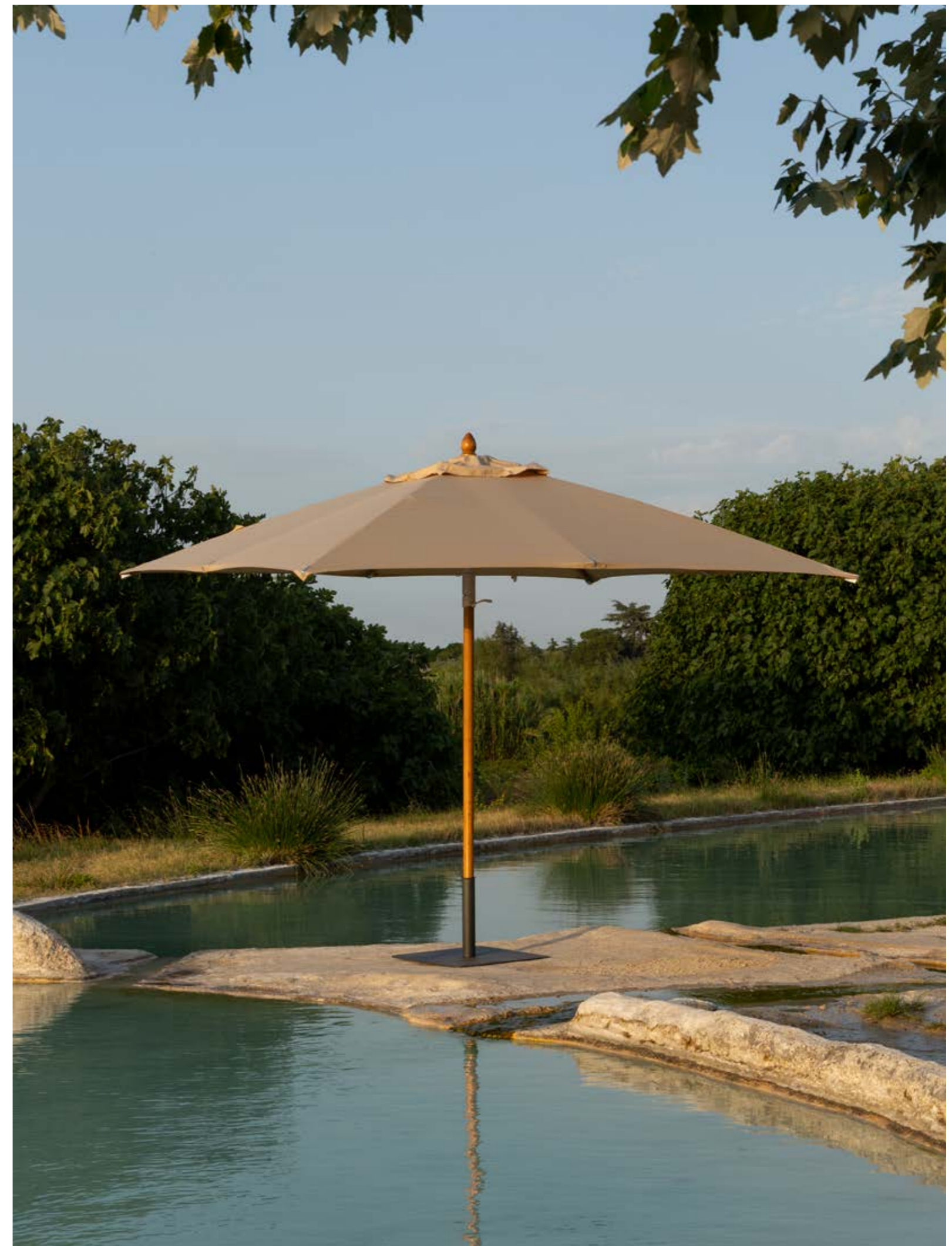

Salento Collection



En -

Salento is a collection of parasols with a contemporary style, featuring a practical lateral support pole. The opening of the awning is available in both motorised and manual versions, to meet different functional and aesthetic needs.

It -

Salento è una collezione di ombrelloni dallo stile contemporaneo, caratterizzati dal pratico palo di sostegno laterale. L'apertura della tenda da sole è disponibile sia motorizzata che manuale, per rispondere alle diverse esigenze funzionali ed estetiche.

Fr -

Salento est une collection de parasols au style contemporain, caractérisés par un mât de soutien latéral très pratique. L'ouverture de la toile est disponible en version motorisée ou manuelle pour répondre aux diverses exigences fonctionnelles et esthétiques.



En -

The base is designed to be used with concrete tiles, sold separately from the structure, which guarantee the equilibrium and balance of the product without invading the space below the covering.

It -

La base è pensata per poter accogliere le piastrelle in cemento che garantiscono l'equilibrio e il bilanciamento del prodotto senza invadere lo spazio sottostante alla copertura.

Fr -

La base est conçue pour pouvoir accueillir les contrepoids en béton qui garantissent l'équilibre du produit sans empiéter sur l'espace abrité par la couverture.

Damian Collection

Design by
Andreucci & Hoisl



En -

The new Damian outdoor parasol by Unopiù brings to mind time spent relaxing and warm elegance with a colonial feel: the structure is entirely made of ash wood. This large parasol is made of acrylic fabric which is resistant to stains, salt and UV rays, and comes in a square or round version. Created by hand, Damian has a rope opening and refined and sophisticated details such as the leather hub runner with visible stitching. Damian is available in the version with brown leather hub runner and ecru cloth with brown piping, or with navy blue leather hub runner and ecru cloth with blue piping. This new versatile outdoor furnishing by Unopiù is ideal for the garden, terrace, beach, boats and poolside.

It -

Il nuovo ombrellone da esterno Damian di Unopiù porta alla mente momenti di relax e un'eleganza calda dal sapore coloniale: la struttura è interamente in legno di frassino. Il grande ombrellone è realizzato in tessuto acrilico resistente alle macchie, alla salsedine e all'azione dei raggi UV, disponibile in versione quadrata o rotonda. Realizzato artigianalmente, Damian ha un'apertura tramite corda e dettagli raffinati e sofisticati come il muscolo in pelle con cucitura a vista. Damian è disponibile nella versione con muscolo in pelle marrone e telo ecru con piping marrone, oppure con muscolo in pelle blu navy e telo ecru con piping blu. Un nuovo, versatile arredo da esterni firmato Unopiù, ideale per giardino, terrazzo, spiaggia, barche e bordo piscina.

Fr -

Le nouveau parasol Damian d'Unopiù porte à l'esprit des moments de détente et une élégance chaleureuse : la structure est entièrement en bois de Frêne. La grande toile est réalisée en tissu acrylique résistant aux taches, au sel et à l'action des rayons UV et disponible en version carrée ou ronde. Fabriqué à la main, Damian a une ouverture manuelle avec corde et des détails raffinés et sophistiqués tels que le coulant en cuir avec couture apparente. Damian est disponible dans la version avec coulant en cuir marron et toile ecru avec passepoil marron, ou avec coulant en cuir bleu marine et toile écru avec passepoil bleu. Un nouveau mobilier d'extérieur polyvalent signé Unopiù, idéal pour jardin, terrasse, plage, bateaux et piscine.



Orangerie Collection

En -

Orangerie is a classically inspired greenhouse system made from galvanised and powder-coated iron with a polycarbonate covering designed to recreate a green environment that is ideal for growing and nurturing plants outside their natural environment.

It -

Orangerie è un sistema di serre d'ispirazione classica, in ferro zincato e verniciato a polveri con copertura in polycarbonato pensata per ricrearsi un'ambiente verde, ideale per coltivare e prendersi cura delle piante fuori dal loro ambiente naturale.

Fr -

Orangerie est une serre d'inspiration classique en fer galvanisé peint revêtu de poudre. Dotée d'une couverture en polycarbonate, elle permet de recréer un espace vert idéal pour cultiver et prendre soin des plantes en dehors de leur environnement naturel.





En ~

Offered in two models, free-standing and wall-mounted, it can adapt to any space. The structure features large polycarbonate surfaces, which are effective at allowing natural, continuous lighting inside. Most of them can be opened to allow the regulation of air flow and to ensure ventilation for the plants.

It ~

Proposta in due modelli, autoportante e addossata, è capace di soddisfare ogni esigenza di spazio. La struttura è caratterizzata da ampie superfici in polycarbonato, efficaci per permettere una naturale e costante illuminazione all'interno. La maggior parte di esse sono apribili, per consentire la regolazione dell'aria e garantire la ventilazione delle piante.

Fr ~

Proposée en deux modèles, autoportante et adossée, elle répond à tous les besoins en terme d'espace. La structure se caractérise par de grandes surfaces en polycarbonato qui permettent d'obtenir un éclairage naturel et constant à l'intérieur. La plupart des modèles sont ouvrables, ce qui assure une régulation de l'air et une bonne ventilation des plantes.



Manta Collection



En -

Manta is a sail with an architectural connotation, designed to generate shaded spaces with practicality and simplicity.

It -

Manta è una vela dalla connotazione architettonica, pensata per generare spazi d'ombra con praticità ed essenzialità.

Fr -

Manta est une voile à connotation architecturale conçue pour créer des espaces ombragés de manière très pratique et simple.

En -

Its structure of Nordic pine in Bangkirai colour combined with PVC coated fabric for the hexagonal shape and acrylic for the rhomboid shape is certified to withstand winds with an intensity of up to 50 km per hour.

It -

La sua struttura composta da pino nordico color Bangkirai combinato al tessuto spalmato di PVC per la forma esagonale, e acrilico per la forma romboidale è certificata per la resistenza a venti di intensità sino a 50 km orari.

Fr -

Sa structure, composée de pin nordique de couleur Bangkirai, se combine à une toile enduite de PVC pour la forme hexagonale et acrylique pour la forme en losange, et elle garantit une résistance à des vents d'une intensité allant jusqu'à 50 km / heure.





Nagi Collection

En

Nagi is a complete system of outdoor structures that can be customised with the utmost freedom, made of impregnated Nordic pine wood in Bankirai or white colour to ensure solidity and durability. Inspired by Japanese aesthetics, the modern circular section profiles instill a sense of airiness and the grids with their geometric striped, diagonal or perpendicular patterns create a balanced play of light and shadow, of full and empty spaces, lending it a sophisticated, contemporary feel.

It

Nagi è un sistema completo di strutture per l'outdoor da personalizzare con massima libertà, realizzato in legno di pino nordico impregnato color Bankirai o bianco per garantire solidità e durevolezza. Ispirato all'estetica giapponese, i profili moderni a sezione circolare infondono un senso di grande leggerezza e i grigliati dai motivi geometrici a righe, diagonali o perpendicolari creano un equilibrato gioco di luci e ombre, pieni e vuoti, donandole un'aria raffinata e contemporanea.

Fr

Nagi est un système complet de structures pour extérieur à personnaliser en toute liberté, réalisé en pin nordique traité de couleur Bankirai ou blanc qui assure solidité et durabilité. Inspiré de l'esthétique japonaise, les profils modernes à section ronde apportent une impression de grande légèreté. Les treillis aux motifs géométriques à rayures, diagonaux ou perpendiculaires créent un jeu d'ombre et de lumière, de pleins et de vides, et confèrent un style raffiné et contemporain.

En -

The structure offers the utmost compositional freedom, allowing the creation of tailor-made solutions, both wall-mounted and freestanding, according to the various needs.

It -

La struttura offre la massima libertà compositiva, dando la possibilità di creare soluzioni su misura, adossate o autoportanti, in base alle diverse esigenze.

Fr -

La structure offre une liberté de composition optimale et permet de créer des solutions sur mesure, adossées ou autoportantes, en fonction des diverses exigences.

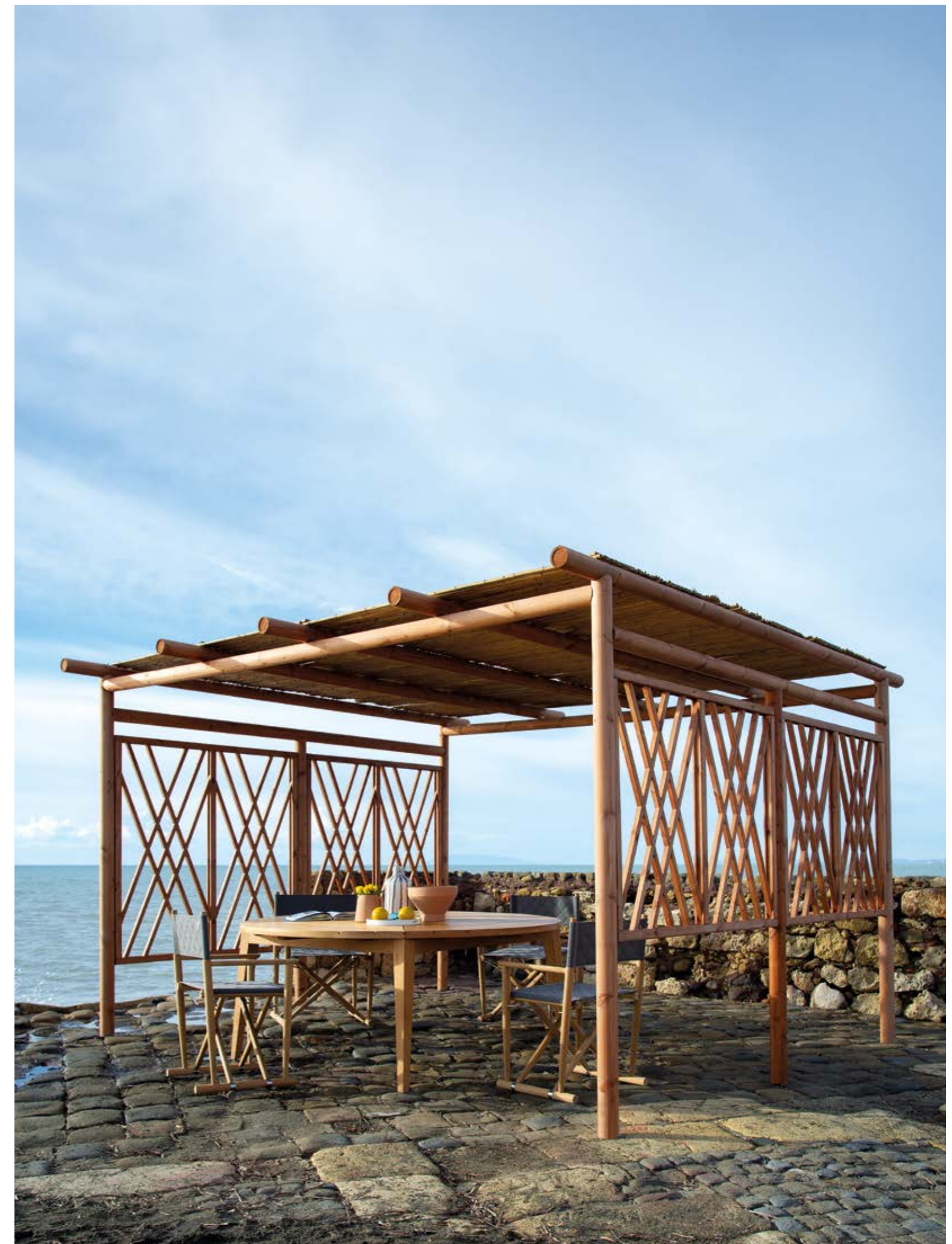
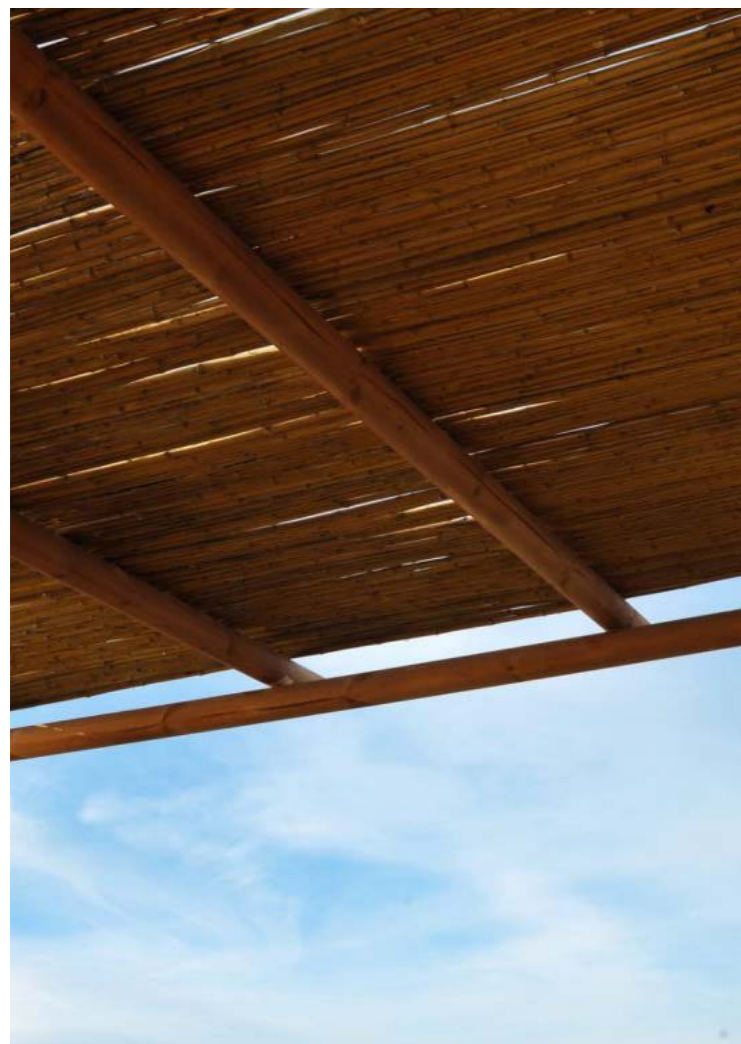

Levante Collection



En -

Levante garden umbrella features the Motion Mechanical Opening System which facilitates its use, making it intuitive, practical and lightweight. The solid base and side arm guarantees a secure anchoring stability and provide a pleasant, and newly restored look, which can diffuse shade to the underlying areas.

It -

L'ombrellone Levante è caratterizzato dal sistema di apertura meccanica Motion, che ne facilita l'utilizzo, rendendolo intuitivo, pratico e leggero. La solida base e il braccio laterale ne assicurano l'ancoraggio e garantiscono all'ambiente sottostante una piacevole ombra diffusa.

Fr -

Le parasol Levante est équipé du système d'ouverture mécanique Motion, qui facilite son utilisation, le rendant à la fois intuitif, pratique et léger. La base solide et le bras latéral assurent son ancrage et fournissent à l'environnement sous-jacent une ombre diffuse agréable.





Covercar Collection

En

The coverings made specially for cars are handcrafted from impregnated Nordic pine in Bangkirai or white color, a wood capable of withstanding all atmospheric agents and temperatures.

It

Le coperture dedicate alle auto sono realizzate artigianalmente in pino nordico impregnato color Bangkirai o bianco un legno resistente a tutti gli agenti atmosferici e temperature.

Fr

Les abris de voiture de fabrication artisanale sont composés de pin nordique imprégné de couleur Bangkirai ou blanc, un bois résistant à tous les agents atmosphériques, quelles que soient les températures.

Dafne Collection



En -

Its perimeter decoration made from graphite-coloured powder-coated galvanised iron makes the traditionally styled Dafne projecting roof stand out. Extensions make it possible to configure the best solution for every need. The embossed polycarbonate covering is an excellent solution for sheltering from bad weather.

It -

La pensilina Dafne dal sapore tradizionale, si distingue per il decoro perimetrale realizzato in ferro zincato verniciato a polveri color grafite. Le estensioni permettono di configurare a piacere la soluzione migliore in base ad ogni esigenza. La copertura in polycarbonato gofrato è un'ottima soluzione per riparare dalle intemperie.

Fr -

Le auvent Dafne de style traditionnel se distingue par le design soigné de sa décoration latérale, réalisée en fer galvanisé peint revêtu de poudre de couleur graphite. Les extensions permettent d'obtenir la configuration la mieux adaptée en fonction des besoins. La couverture en polycarbonate gaufré offre une solution parfaite pour se protéger des intempéries.



En -

The canopy boasts different shapes and sizes: a flat one with rounded ends measuring 217x60 cm or 317x60 cm with the option of extending up to 201 or 301 cm; and a more geometric and square-shaped one with a length of 240, 280 or 320 cm and a height of 104 cm.

It -

La pensilina vanta diverse forme e dimensioni: una piatta con estremità arrotondate di 217x60 cm o 317x60 cm con possibilità di estensione fino a 201 o 301 cm; e una più geometrica e squadrata dalla lunghezza di 240, 280 o 320 cm e altezza di 104 cm.

Fr -

L'auvent se décline sous différentes formes et dimensions : plat aux extrémités arrondies mesurant 217x60 cm ou 317x60 cm avec possibilité d'extension jusqu'à 201 ou 301 cm ; et un plus géométrique et à trois pentes avec une longueur de 240, 280 ou 320 cm et une hauteur de 104 cm.



05.

Aton
Tratto
Solare
Hotty
Carpets
Vases
Solar Shower
Jolly Cushions



Aton Collection

Design by
Marco Acerbis

En -

Designed by Marco Acerbis, Aton combines its simple shape with detail provided by the torsion of aluminium slats in the compositional process, which characterises all the lamps in the collection. The line is available in white and bronze colours and its discreet look makes it an ideal accessory both indoors and outdoors.

It -

Disegnata da Marco Acerbis, Aton unisce alla sua forma semplice il dettaglio della torsione delle lamelle d'alluminio come lavorazione compositiva, che caratterizza tutte le lampade della collezione. La linea è disponibile nelle tonalità del bianco e del bronzo, e il suo aspetto discreto la rende un accessorio ideale sia all'interno che all'esterno.

Fr -

Conçue par Marco Acerbis, Aton offre une forme simple agrémentée de lames torsadées en aluminium, élément décoratif qui caractérise toutes les lampes de cette collection. La gamme est disponible dans les tonalités blanc et bronze, et son aspect discret en fait un accessoire idéal à l'intérieur comme à l'extérieur.

En -

The modern, sophisticated design of the shape comes to the fore when the light is switched on, as it delicately traverses the structure, transforming the environment into a warm, evocative landscape, full of shadows with delicate geometries.

It -

Il design moderno e curato della forma diventa funzionale con l'accensione della fonte luminosa, che si propaga delicatamente attraverso la struttura, trasformando l'ambiente in un paesaggio caldo e suggestivo, in cui si disegnano ombre dalle delicate geometrie.

Fr -

Présentant une forme moderne et soignée, le design devient fonctionnel lorsque la lampe est allumée, la source lumineuse se diffusant délicatement à travers la structure et transformant l'espace en un cadre chaleureux et suggestif où se dessinent des ombres aux motifs géométriques.





Tratto Collection

Design by
Studiomartino.5

En -

A collection of lamps distinguished by visual lightness and formal purity. Tratto draws inspiration from the abstract world of linear geometry and stands out for the essentiality of its sign. A completely transversal outdoor lighting solution, it adapts in a versatile way to any type of environment, where its square sign creates a strong and pleasant contrast between nature and artifice.

It -

Collezione di lampade che si distinguono per leggerezza visiva e purezza formale. Tratto trae ispirazione dal mondo astratto della geometria lineare e spicca per l'essentialità del segno. Soluzione di outdoor lighting completamente trasversale, si adatta in modo versatile a qualsiasi tipo di ambiente, dove il suo segno squadrato crea un forte e piacevole contrasto tra natura e artificio.

Fr -

Une collection de lampes qui se distinguent par leur légèreté visuelle et leur pureté formelle. Tratto s'inspire du monde abstrait de la géométrie linéaire et se distingue par l'essentialité de la ligne. Solution d'éclairage extérieur complètement transversale, elle s'adapte de manière polyvalente à tout type d'environnement, où sa marque de fabrique carrée crée un contraste fort et agréable entre nature et artifice.

En -

The solid base in Pietra Serena is superimposed on the slender tubular structure with a square section in cold galvanised, graphite-coloured powder-coated steel. Available in different variants: in the step marker model, in three sizes, high, medium and low, and in the wall sconce declination.

It -

La solida base in Pietra Serena si sovrappone alla snella struttura tubolare a sezione quadrata in acciaio zincato a freddo, verniciato a polveri color grafite. Disponibile in diverse varianti: nel modello segna passo, in tre misure, alta, media e bassa, e nella declinazione appliche.

Fr -

La base solide en pierre Serena se superpose à la structure tubulaire mince à section carrée en acier galvanisé à froid, peinture poudre couleur graphite. Disponible en différentes variantes: le modèle borne, en trois tailles, haute, moyenne et basse, et la déclinaison murale.



Solare Collection



En -

Solare is a collection of lamps and lanterns where the versatility of the lines is expressed through materials, colours and shapes designed to respond to various functional and aesthetic needs. All the models share the same light source: an LED solar panel integrated into the structure that is rechargeable and adjustable in terms of intensity and diffuses an intense light that transforms any room into a warm, domestic landscape.

It -

Solare è una collezione di lampade e lanterne dove la versatilità delle linee si esprime attraverso materiali, colori e forme immaginate per rispondere a diverse esigenze funzionali ed estetiche. Ciò che unisce tutti i modelli è la fonte luminosa: il LED a pannelli solari integrato nella struttura, ricaricabile e regolabile nell'intensità, diffonde una luce intensa che trasforma ciascun ambiente in un caldo paesaggio domestico.

Fr -

Solare est une gamme de lampes et de lanternes présentant une grande variété de lignes à travers les matériaux, les couleurs et les formes, conçus pour répondre à diverses exigences fonctionnelles et esthétiques. Le point commun de tous ces modèles est la source lumineuse : le panneau solaire LED intégré à la structure, rechargeable et à l'intensité réglable, diffuse une lumière intense qui transforme tous les lieux en un cadre chaleureux et intime.



En -

Solare lanterns made of natural teak wood have been designed in two different styles and can be enjoyed in different settings to illuminate the area, while creating a warm and relaxing atmosphere in outdoor spaces through an enveloping light. The adjustable LED light allows you to create an intimate and relaxing atmosphere, while the handle enables them to be mounted and easily moved from one place to another.

It -

Le lanterne Solare in legno di teak naturale sono state progettate in due diverse forme e possono essere collocate in diversi ambienti per illuminare e riscaldare gli spazi outdoor attraverso una luce avvolgente. Il LED regolabile consente di creare un'atmosfera intima e rilassante, la maniglia inoltre permette di appenderle e trasportarle con facilità.

Fr -

Les lanternes Solare en bois de teck, proposées sous deux formes différentes, trouveront leur place dans les environnements les plus divers. Leur lumière enveloppante éclaire les espaces extérieurs en apportant une ambiance chaleureuse. La LED réglable permet de créer une atmosphère intime et relaxante, et la poignée est très pratique pour les suspendre et les transporter facilement.



Hotty Collection



En

Hotty is a collection of infrared aluminium heating lamps, created to make the outdoor environment comfortable even in the coldest weather.

It

Hotty è una collezione di lampade riscaldanti ad infrarossi in alluminio, pensate per rendere confortevole l'ambiente esterno anche nei periodi più freddi.

Fr

Hotty est une collection de lampes chauffantes à infrarouges en aluminium, spécialement conçues pour apporter plus de confort aux espaces extérieurs, même durant les périodes les plus froides de l'année.

Carpets Collection



En

Craftsmanship and sustainability blend to produce the Unopiù collection of rugs with clean designs and soft colour combinations, weaved using hand looms with polyester yarn that is produced from everyday recycled PET bottles.

General catalogue

It

Tra artigianalità e sostenibilità, nasce la collezione di tappeti Unopiù dal design pulito e dai tenui accostamenti cromatici, lavorati con telai a mano il cui filato di poliestere viene prodotto a partire dal riciclo delle comuni bottiglie di PET.

Fr

La collection de tapis Unopiù, de fabrication artisanale et durable, présente un design soigné et des combinaisons de couleurs subtiles. Les tapis sont tissés soigneusement à la main à partir de fils en polyester issu de bouteilles en PET recyclées.

287



Vases Collection



En -

Essential accessories to complete the outdoors, Unopiù vases are characterised by discreet shapes and classic colours, so that the surrounding environment may be decorated without sacrificing style.

It -

Complementi immancabili per completare l'outdoor, i vasi Unopiù sono caratterizzati da forme discrete e colori classici, per permettere di corredare l'ambiente che li ospita senza rinunciare allo stile.

Fr -

Éléments incontournables pour compléter les espaces extérieurs, les vases Unopiù se caractérisent par leurs formes discrètes et leurs couleurs classiques, qui permettent de les coordonner à l'environnement sans renoncer au style.

Solar Shower Collection



292

En -

Solar Shower is based on the idea of a shower as a personal space that should be enjoyed outdoors, in complete harmony with the natural landscape. Its mobility guarantees its installation anywhere, according to needs. Hot Ball is the technological and sustainable solution that completes it, a collector of up to 40 litres of water that heats it by using solar energy, thereby ensuring the utmost comfort at all times.

General catalogue

It -

Solar Shower nasce dall'idea di immaginare la doccia come uno spazio personale da godersi all'aria aperta, in totale armonia con il paesaggio naturale. La sua mobilità garantisce la possibilità di installarla a piacere, a seconda delle esigenze. Hot Ball è la soluzione tecnologica e sostenibile che la completa, collettore che raccoglie sino a 40 litri d'acqua e la riscalda grazie all'energia solare, garantendo così il massimo comfort in ciascun momento.

Fr -

Avec Solar Shower, la douche est conçue comme un espace personnel dont on peut profiter en plein air et en totale harmonie avec le cadre naturel. Sa mobilité permet de l'installer à votre convenance, en fonction des besoins. La douche est accompagnée du capteur solaire Hot Ball, une solution technologique durable d'une capacité allant jusqu'à 40 litres d'eau. L'eau est chauffée grâce à l'énergie solaire, pour offrir à tout moment un confort optimal.

293

En -

The large 250 mm shower head guarantees a wide, pleasant jet, which can be adjusted using the mixer and is held by a polyethylene support. The base, made from precious Okumè wood, adds an elegant, sophisticated touch to the product. The Hot Ball collector, with a capacity of 40 litres, can be installed both on a roof or on the ground. Its composition of mass-dyed graphite-coloured resin and aluminium guarantees excellent resistance to impacts and wear caused by atmospheric agents. The water can be heated using both electricity and solar energy.

It -

L'ampio soffione di 250 mm garantisce un getto diffuso e piacevole, regolabile dal miscelatore ed è sorretto da un sostegno in polietilene. Il basamento in pregiato legno di Okumè aggiunge un dettaglio elegante e sofisticato al prodotto. Il collettore Hot Ball, con una capienza di 40 litri, può essere installato a piacere sia su un tetto che a terra. La sua composizione in resina color grafite tinta in massa e alluminio garantisce un'ottima resistenza agli urti e all'usura da agenti atmosferici. L'acqua può essere riscaldata sfruttando sia l'elettricità che l'energia solare.

Fr -

Le grand pommeau de douche de 250 mm garantit un jet large et agréable. Réglable à partir du mélangeur, il est soutenu par un support en polyéthylène. La base en bois précieux d'Okoumé apporte une touche élégante et raffinée au produit. Le capteur solaire Hot Ball, d'une capacité de 40 litres, peut être installé sur un toit ou sur le sol. Sa composition en résine de couleur graphite teinte dans la masse garantit une résistance optimale aux chocs et à l'usure due aux agents atmosphériques. L'eau peut être chauffée à l'aide de l'énergie électrique ou solaire.





Jolly cushions Collection

En -

Jolly cushions, available in various sizes, are essential to enriching and completing all Unopiù collections with elegance and harmony. Functionality and aesthetics nevertheless allow the linings to be removed for proper maintenance and customised in the various shades of the Unopiù colour collection.

It -

I cuscini Jolly, disponibili in diversi formati, sono indispensabili per arricchire e completare tutte le collezioni Unopiù. Funzionalità ed estetica si distinguono nella possibilità di sfoderarli per permetterne la corretta manutenzione, e personalizzarli nelle diverse cromie della Colour Collection Unopiù.

Fr -

Les coussins Jolly, disponibles en divers formats, sont indispensables pour enrichir et compléter toutes les collections Unopiù. À la fois esthétiques et fonctionnels, ils sont déhoussables, ce qui facilite leur entretien et permet de les personnaliser grâce à la vaste palette de coloris de la Colour Collection Unopiù.

En -

The use of mass-dyed technical fabrics, which are very resistant to wear and UV rays, also make the cushions perfect for indoor solutions, thanks to innovative finishing techniques that ensure the colours do not fade over time.

It -

L'utilizzo di tessuti tecnici tinti in massa, dall'alta resistenza all'usura ed i raggi UV, rendono i cuscini perfetti anche per soluzioni indoor, grazie agli innovativi trattamenti di finissaggio che garantiscono il mantenimento dei colori inalterato nel tempo.

Fr -

L'utilisation de tissus techniques teintés dans la masse, hautement résistants à l'usure et aux rayons UV, rend ces coussins parfaits également pour le mobilier d'intérieur, grâce au traitement innovant de finition qui garantit la conservation des couleurs au fil du temps.





Fabrics

En -

Unopiù dresses the outdoor with excellence and craftsmanship. The brand offers a rich and colourful textile proposal, which varies in patterns, nuances and textures, leaving great freedom of choice in combinations and countless possibilities for customisation of its upholstery. The cushions can be upholstered at will with bouclé fabrics, shaved and unshaved, plain, narrow, wide, vertical and horizontal stripes, all in various coordinating shades. Unopiù's fabrics combine excellent characteristics of resistance to atmospheric agents with a high aesthetic value, giving a feeling of elegance, hospitality and pleasant tactility. The chosen materials are certified and performing, and all specific for the outdoor, among the wide range there are fabrics in water-repellent acrylic, waterproof and recycled acrylics of new generation.

It -

Unopiù veste l'outdoor con eccellenza e artigianalità. Il brand offre una proposta tessile ricca e colorata, che varia per fantasia, nuance e texture, lasciando una grande libertà di scelta negli abbinamenti e innumerevoli possibilità di personalizzazione per i propri imbottiti. I cuscini possono essere rivestiti a piacere con tessuti bouclé, rasati e non, a tinta unita, a righe strette, larghe, verticali e orizzontali, tutti in varie tonalità tra loro coordinabili. I tessuti Unopiù, combinano ottime caratteristiche di resistenza agli agenti atmosferici e un elevato valore estetico, donando una sensazione di eleganza, ospitalità e piacevole tattilità. I materiali scelti sono certificati e performanti, e tutti specifici per l'outdoor, tra la vasta gamma si trovano tessuti in acrilico idrorepellente, waterproof e acrilici riciclati di nuova generazione.

Fr -

Unopiù habille l'extérieur avec excellence et artisanat. Unopiù propose une large palette de textiles riches et colorée, qui varie selon les fantaisies, les nuances et les textures, laissant une grande liberté de choix dans les combinaisons et d'innombrables possibilités de personnalisation du rembourrage. Les coussins peuvent être recouverts à volonté de tissus bouclés, lisses ou rugueux, de couleur unie, à rayures étroites, larges, verticales et horizontales, le tout dans différentes nuances pouvant être coordonnées. Les tissus Unopiù combinent d'excellentes caractéristiques de résistance aux agents atmosphériques et une grande valeur esthétique, donnant une sensation d'élégance, d'hospitalité et sont agréables au toucher. Les matériaux choisis sont certifiés et performants, et tout particulièrement pour l'extérieur. Parmi la vaste gamme vous trouverez des tissus en acrylique hydrofuge, waterproof et acryliques recyclés de nouvelle génération.

Masterline Collection

NUVOLA

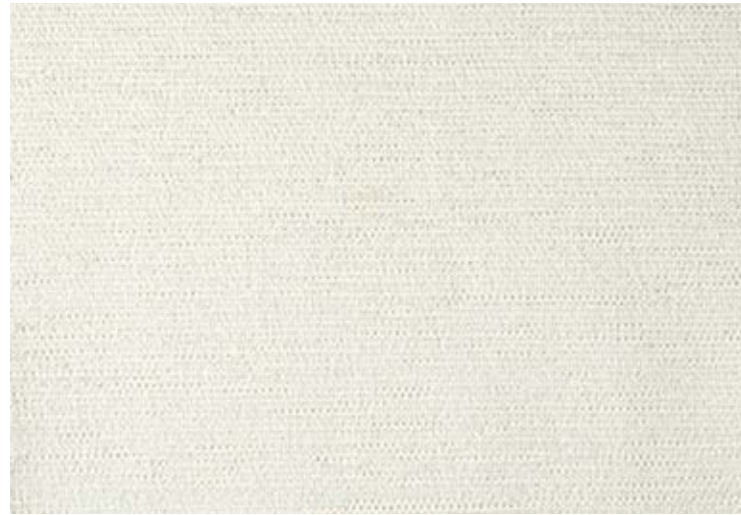

C01

LATTE

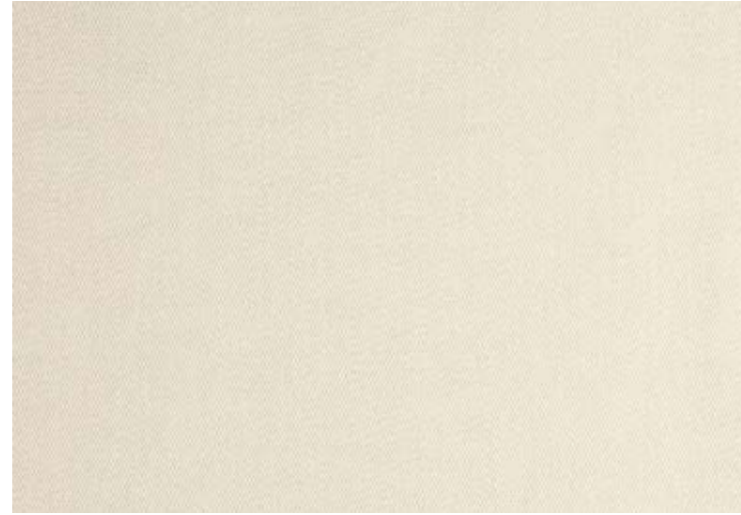

04

ONICE BIANCO

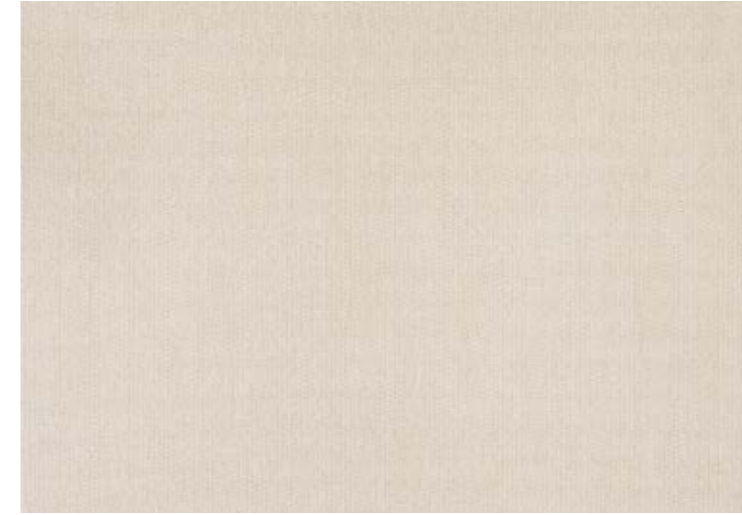

147 Waterproof

BISCOTTO



153

PERLA INTENSO

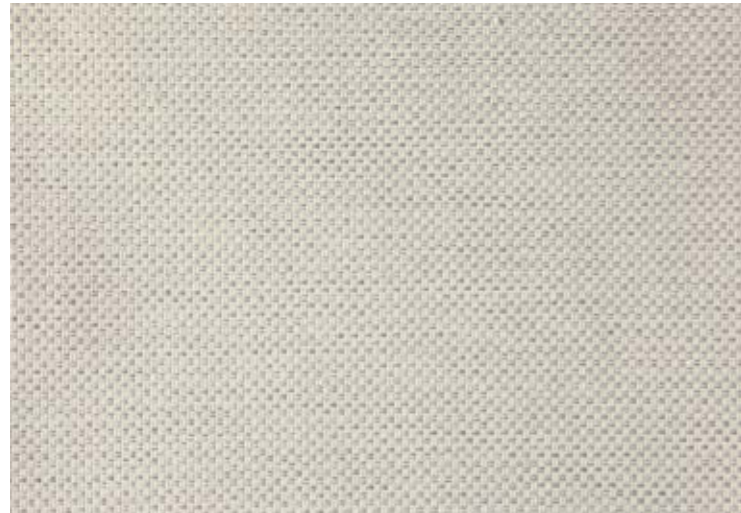

120 Waterproof

PERLA DELICATO



130 Waterproof

NOCCIOLA



115

GRANITO



129 Waterproof

CAMMEO INTENSO

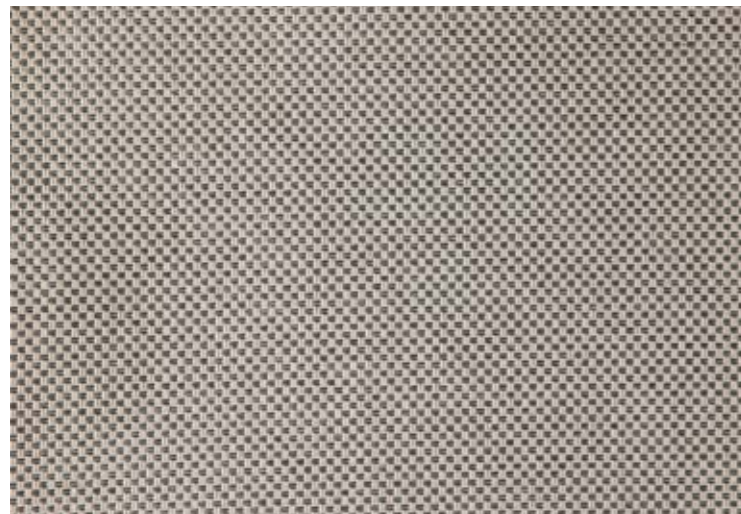

121 Waterproof

CAMMEO DELICATO



131 Waterproof

Masterline Collection

TOPAZIO



128 Waterproof

TURCHESE DELICATO



136 Waterproof

LIMONE



141

ARDESIA DELICATO

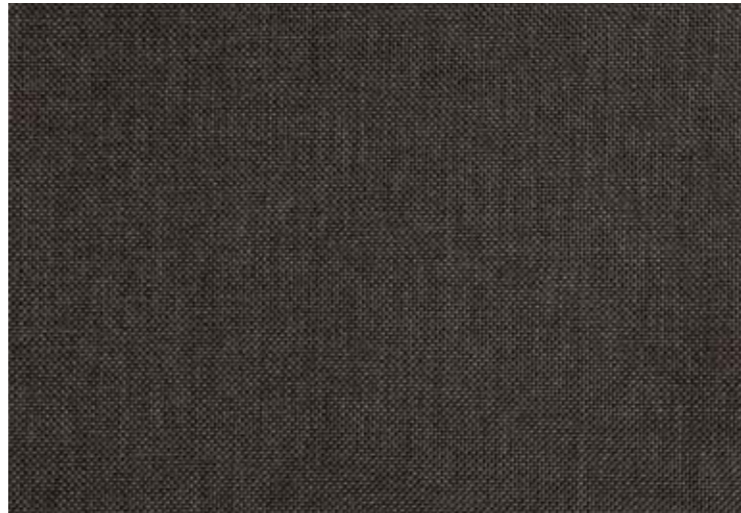

138 Waterproof

Essential Collection

PAPIRO



156 Recycled Acrylic / Acrilico riciclato / Acrylique recyclé

SENAPE



164

MUSCHIO



154 Recycled Acrylic / Acrilico riciclato / Acrylique recyclé

COTTO



155 Recycled Acrylic / Acrilico riciclato / Acrylique recyclé

AMETISTA



163

Essential Collection

GHIAIA



158

ARGILLA



157

RIGHE BEIGE



165

LINEA BEIGE



168

OLIVINA



160

PORFIDO



159

RIGHE ARGILLA



166

LINEA BLU



169

DELFT



162

PERSIA

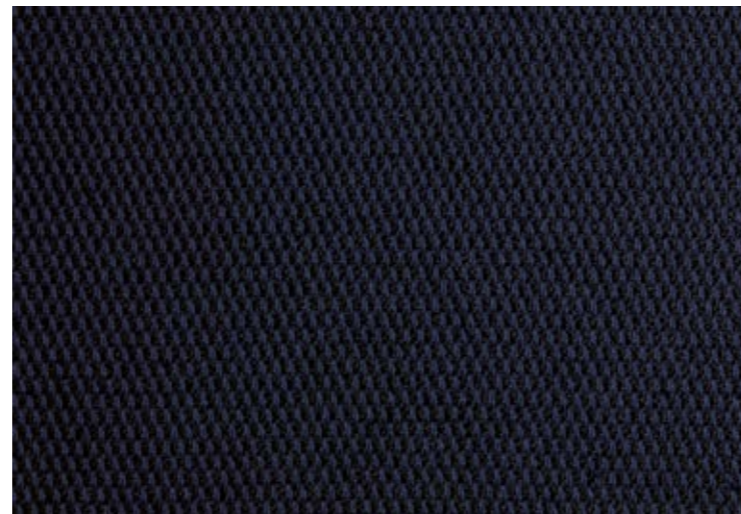

161

RIGHE JEANS



167

Art Collection

BOUCLE BEIGE



170

ROMBI AVORIO



173

TRATTEGGIO AVORIO



176

TRATTEGGIO BEIGE



177

BOUCLE GRIGIO



171

ROMBI BLU



175

TRATTEGGIO BLU



178

BOUCLE BIANCO CALDO



172

ROMBI TERRACOTTA



174

Tailored Collection

SUMMERTIME NAVY by Dedar

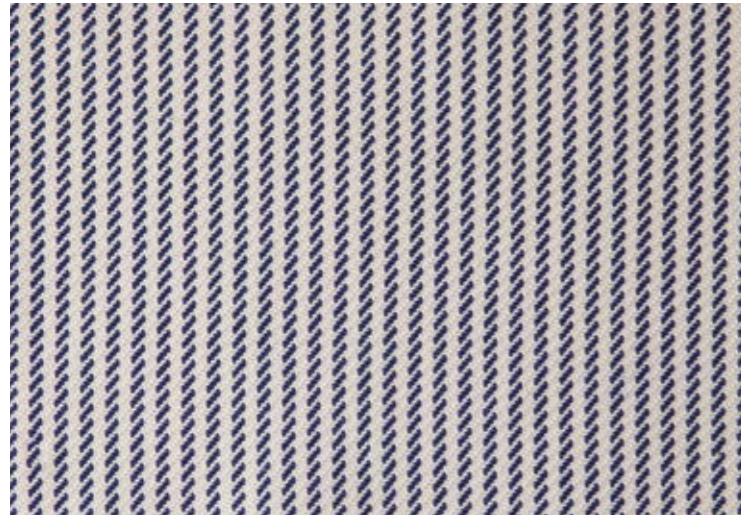

SUMMERTIME BEIGE by Dedar

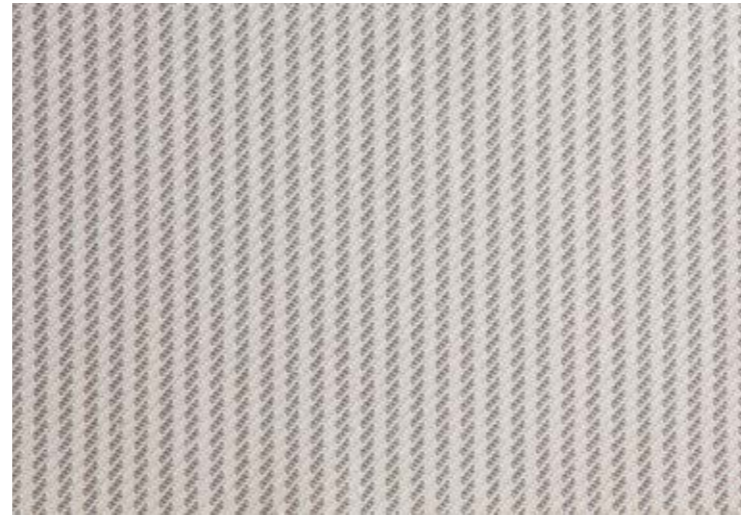

SUMMERTIME YOUNG AND LOVELY CIELO AZZURRO by Dedar



001

SUMMERTIME YOUNG AND LOVELY ROUGE MARINIERRE by Dedar



002

SUMMERTIME FORESTA by Dedar

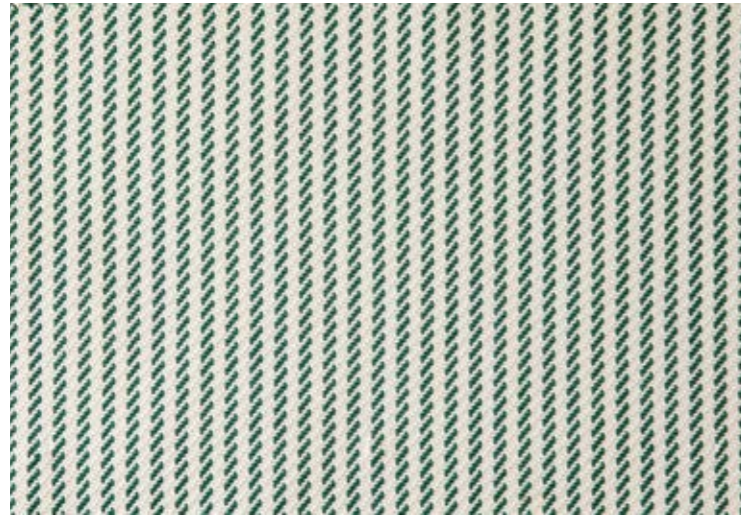

005

SUMMERTIME CLEMENTINE by Dedar

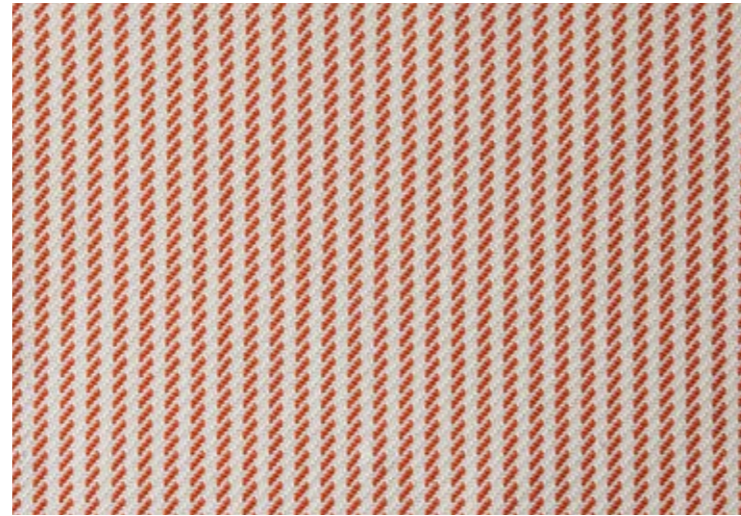

008

SUMMERTIME YOUNG AND LOVELY CHIAROSCURO by Dedar



003

SUMMERTIME YOUNG AND LOVELY FORESTA by Dedar



004

Tailored Collection

DEHORS GRIMAUD COVES by Loro Piana



DEHORS GRIMAUD GINGER by Loro Piana



DEHORS GRIMAUD INDIGO by Loro Piana



DEHORS GRIMAUD MALACHITE by Loro Piana



DEHORS SAINT TROPEZ COWES by Loro Piana



DEHORS SAINT TROPEZ GINGER by Loro Piana



DEHORS SAINT TROPEZ INDIGO by Loro Piana



DEHORS SAINT TROPEZ MALACHITE by Loro Piana



DEHORS BAULIEU COWES by Loro Piana



DEHORS BAULIEU GINGER by Loro Piana



DEHORS BAULIEU INDIGO by Loro Piana



DEHORS BAULIEU MALACHITE by Loro Piana



Tailored Collection

FABRHIRTY HUGO—BIANCO by Rubelli



—

FABRHIRTY BIANCO by Rubelli



30319—001

FABRHIRTY+ DESERTO by Rubelli



30467—36

FABRHIRTY+ TERRA DI SIENA by Rubelli



30467—42

FABRHIRTY HUGO—PIETRA by Rubelli



—

FABRHIRTY GRIGIO by Rubelli



30319—009

FABRHIRTY GIALLO by Rubelli



30319—17

FABRHIRTY+ PINO by Rubelli



30467—52

FABRHIRTY HUGO—AVORIO by Rubelli



—

FABRHIRTY+ TERRA by Rubelli



30467—35

FABRHIRTY+ AZZURRO by Rubelli



30467—56

Tailored Collection

KOLYMBETRA BEIGE by Mariaflora



20

KOLYMBETRA BLUE by Mariaflora



80

KOLYMBETRA GRAY by Mariaflora

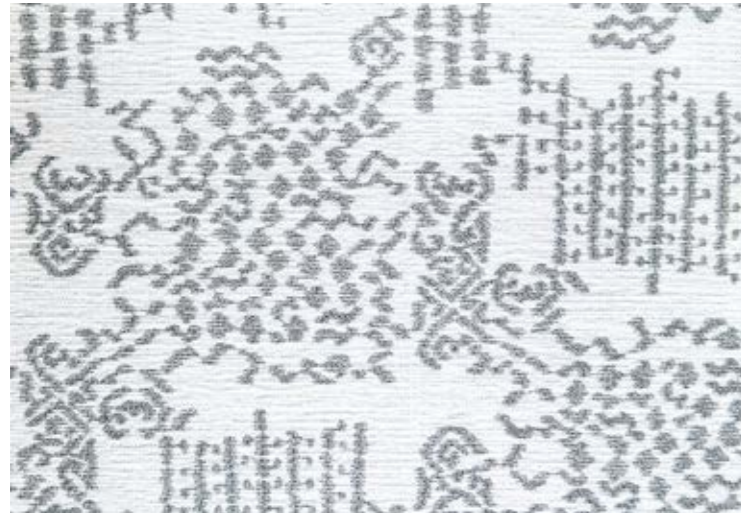

100

UK Color Collection



12i white



21i cord



19i dove grey



15i grey



17i sky blue



18i bright blue



13i acid green



01i orange

COMPOSITION
100% High tenacity Polyester

WEIGHT
400 g/m2 ± 15

WIDTH
140 cm ± 2

ROLL LENGTH
25 mt ± 5%

ABRASION RESISTANCE
> 200000 Martindale cycles

LIGHT FASTNESS
(EN ISO 105-B02) 4

COLOUR
Slight colour differences between one lot and another have to be considered within commercial tolerance

FASTNESS TO RUBBING
(EN ISO 105-X12) Wet: 4 - Dry: 4

FLAMMABILITY
EN 1021-1:2006
EN 1021-2:2006
BS 5852:2006 (CRIB 5) M1
California
Technical Bulletin 117:2013

Furnishings Technical Sheets

Agorà
Amanda
Ariete
Aurora
Capri
Clio
C'est La Vie
Chelsea
Coco
Conrad
Davos
Emy
Experience
Fresbee
Ginger

Luce
Lulù
Nanda
Nacre
Olimpia
Panarea
Pevero
Synthesis
Swing
Titanic
Toscana
Treble
Welcome
William

Agorà

SITTING AND LOUNGE / SEDUTA E LOUNGE / ASSISE ET LOUNGE / SITZMÖBEL

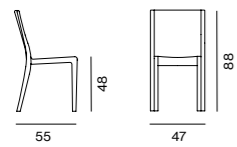

Chair / Sedia / Chaise / Stuhl

SEAGB White / Bianco / Blanc / Weiß
SEAGTBR Tropical brown

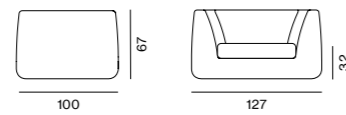

Armchair / Poltrona / Fauteuil / Sessel

AGPOB White / Bianco / Blanc / Weiß
AGPOT Tropical brown
AGCUPO Cushion / Cuscino
 Coussin / Sitzpolster

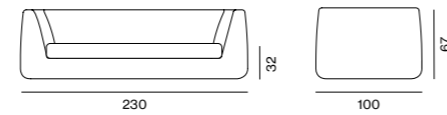

Sofa / Divano / Canapé / Sofa

AGDIB White / Bianco / Blanc / Weiß
AGDIT Tropical brown
AGCUDI Cushion / Cuscino
 Coussin / Sitzpolster

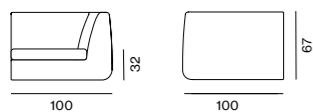

Corner Module / Modulo angolare
 Module angulaire / Eckmodul

AGANB White / Bianco / Blanc / Weiß
AGANT Tropical brown
AGCUAN Cushion / Cuscino
 Coussin / Sitzpolster

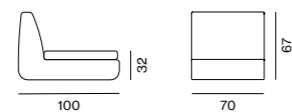

Backrest module / Modulo spalla
 Module dossier / Rückenlehnenmodul

AGSPB White / Bianco / Blanc / Weiß
AGSPT Tropical brown
AGCUSP Cushion / Cuscino
 Coussin / Sitzpolster



R end module / Modulo finale dx
 Module terminal d / Endmodul rechts

AGMFBD White / Bianco / Blanc / Weiß
AGMFTD Tropical brown
AGCUMF Cushion / Cuscino
 Coussin / Sitzpolster

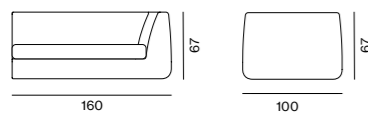

L End module / Modulo finale sx
 Module terminal g / Endmodul links

AGMFBS White / Bianco / Blanc / Weiß
AGMFTS Tropical brown
AGCUMF Cushion / Cuscino
 Coussin / Sitzpolster

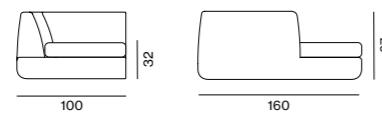

R Lounge module / Modulo lounge dx
 Module lounge d / Loungemodul rechts

AGMLBD White / Bianco / Blanc / Weiß
AGMLTD Tropical brown
AGCUMLD Cushion / Cuscino
 Coussin / Sitzpolster

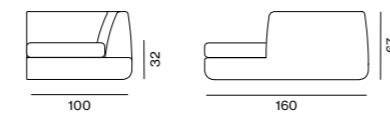

L lounge module / Modulo lounge sx
 Module lounge g / Loungemodul links

AGMLBS White / Bianco / Blanc / Weiß
AGMLTS Tropical brown
AGCUMLS Cushion / Cuscino
 Coussin / Sitzpolster

SUNLOUNGER / LETTINO / BAIN DE SOLEIL / SONNENLIEGE

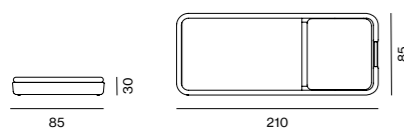

Sunlounger / Lettino / Bain de soleil / Sonnenliege

AGLEB White / Bianco / Blanc / Weiß
AGLET Tropical brown
AECU Cushion / Cuscino
 Coussin / Polsterauflage



Island / Struttura isola / Îlot / Sonneninsel

EDISTB White / Bianco / Blanc / Weiß
EDIST Tropical brown
EDCUIS Cushion / Cuscino
 Coussin / Sitzpolster

TABLES / TAVOLI / TABLES / TISCHE

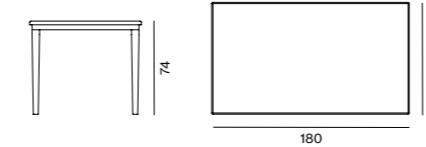

Rectangular table / Tavolo rettangolare
 Table rectangulaire / Rechteckiger Tisch

TAGRB White / Bianco / Blanc / Weiß
TAGRTBR Tropical brown

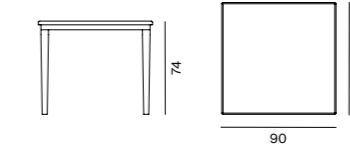

Square table / Tavolo quadrato
 Table carrée / Quadratischer Tisch

TAGQB White / Bianco / Blanc / Weiß
TAGQTBR Tropical brown

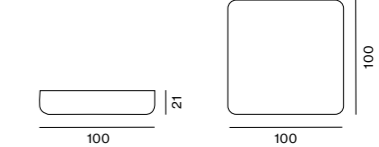

Square coffee table / Tavolo basso quadrato
 Table basse carrée / Quadratischer Couchtisch

BAGTAB White / Bianco / Blanc / Weiß
AGTAB Tropical brown
AGCUPU Cushion pouf / Cuscino pouf
 Coussin pouf / Kissenauflage für Hocker

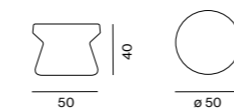

Round coffee table / Tavolo basso rotondo
 Table basse ronde / Runder Couchtisch

EDPTTB White / Bianco / Blanc / Weiß
EDPTT Tropical brown
VETAED50 Glass top / Top in vetro
 Verre pour table / Glasplatte
EDCUPU Cushion pouf / Cuscino pouf
 Coussin pouf / Kissenauflage für Hocker

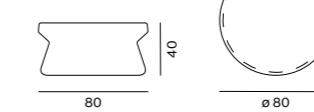

Glass top Coffee table / Tavolo basso con top in vetro
 Table basse avec plateau en verre / Couchtisch mit Glasplatte

TAED80B White / Bianco / Blanc / Weiß
TAED80 Tropical brown

FINISHES / FINITURE / FINITIONS / AUSFÜHRUNGEN

WaProLace® Synthetic fibre tropical brown
 Fibra sintetica WaProLace® tropical brown
 Fibre synthétique WaProLace® tropical brown
 WaProLace® Synthetikfaser tropical brown

Removable cushions Masterline Colour Collection p. 302
 Cuscini sfoderabili Masterline Colour Collection pg. 302
 Coussins déhoussables Masterline Colour Collection pg. 302
 Abziehbare Kissen Masterline Kollektion Seite 302

Synthetic fibre white
 Fibra sintetica bianca
 Fibre synthétique blanche
 Synthetikfaser weiß

→ Aluminum / Alluminio / Aluminium / Aluminium
 → WaProLace® synthetic fibre / Fibra sintetica WaProLace® / Fibre synthétique WaProLace® / WaProLace® Synthetikfaser
 → Removable cushions col. standard Nuvola C01 / Cuscini sfoderabili col. standard Nuvola C01 / Coussins déhoussables coul. standard Nuvola C01
 Abziehbare Polster Standardfarbe Nuvola C01

Amanda

HAMMOCK / AMACA / HAMAC / HÄNGEMATTE

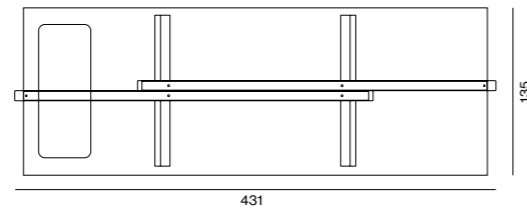
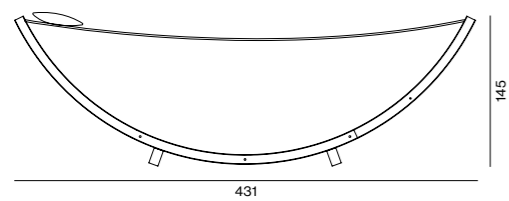

Wooden hammock / Amaca in legno / Hamac en bois / Hängematte mit Holzgestell

- AMACA** 100% cotton off white / Cotone bianco naturale
Coton blanc 100% naturel / 100% Baumwolle naturfarben
- AMACAGM** Polypropylene grey mélange / Polipropilene grigio mélange
Polypropylène gris chiné / Polypropylen graumeliert

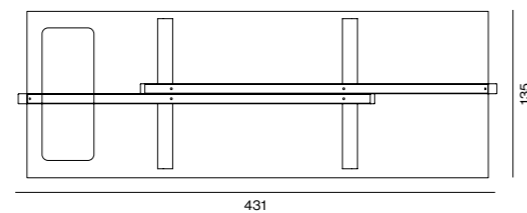
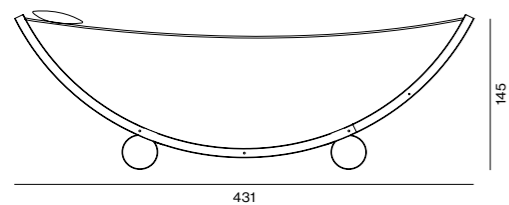

Hammock with wooden structure and galvanized steel base / Amaca struttura legno e base in acciaio galvanizzato

Hamac base en acier galvanisé naturel et structure en bois / Hängematte mit Holzgestell und verzinktem Unterteil aus verzinktem Stahl

- AMACABF** 100% cotton off white / Cotone bianco naturale
Coton blanc 100% naturel / 100% Baumwolle naturfarben

COMPLEMENTS / COMPLEMENTI / COMPLÉMENTS / ZUBEHÖR

Net 100% cotton off-white	Rete in corda di cotone bianco grezzo	Filet en corde de coton blanc écru	Netz aus Baumwolle naturfarben	RETE
Net in grey mélange polypropilene	Rete in corda in polipropilene grigio mélange	Filet de corde en polypropylène gris chiné	Netz aus Polypropylen graumeliert	RETEGM
Cushion in quarzo fumé	Cuscino in quarzo fumé	Coussin quartz fumé	Kissen aus Stoff "quarzo fumé"	AMACACUSA002

FINISHES / FINITURE / FINITIONS / AUSFÜHRUNGEN

- 100% cotton off white
Cotone bianco naturale
Coton blanc 100% naturel
100% Baumwolle naturfarben
- Polypropylene grey mélange
Polipropilene grigio mélange
Polypropylène gris chiné
Polypropylen grau meliert
- Treated lamellar wood walnut
Legno lamellare impregnato tinto noce
Bois lamellé imprégné couleur noyer
Behandeltes Schichtholz nussfarben
- Natural galvanized steel
Acciaio galvanizzato naturale
Acier galvanisé naturel
Naturbelassener verzinkter Stahl

- Treated lamellar wood / Legno lamellare impregnato / Bois lamellaire recourbé / Behandeltes Schichtholz
- Natural galvanized steel / Acciaio galvanizzato naturale / Acier galvanisé naturel / naturbelassener verzinkter Stahl
- 100% cotton / Cotone grezzo / coton blanc / 100% Baumwolle
- Polypropylene / Polipropilene / Polypropylène / Polypropylen

Ariete

SITTING / SEDUTE / ASSISES / SITZMÖBEL

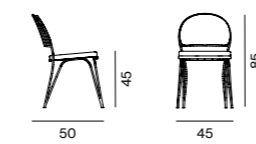

- ARISEDDBR** Chair / Sedia / Chaise / Stuhl
- CUARISED** Cushion / Cuscino / Coussin / Sitzkissen
- CUARISEDSC** Backrest cushion / Cuscino schienale
Coussin de dossier / Rückenkissen

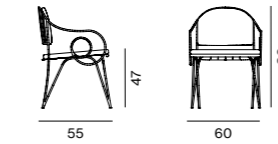

- ARIPOBR** Small armchair / Poltroncina
Petit fauteuil / Armstuhl
- CUARIP** Cushion / Cuscino / Coussin / Sitzkissen
- CUARIPSC** Backrest cushion / Cuscino schienale
Coussin de dossier / Rückenkissen

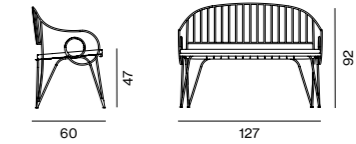

- ARIPANBR** Bench / Panchetta / Banc / Bank
- CUARIPAN** Cushion / Cuscino
Coussin / Sitzpolster

LOUNGE / LOUNGE / LOUNGE / LOUNGE

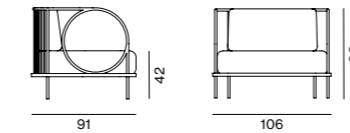

- ARIPOLGBR** Armchair / Poltrona / Fauteuil / Sessel
- CUARIPOL** Cushion / Cuscino
Coussin / Sitzpolster

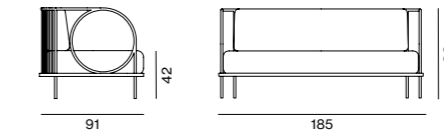

- ARIDIVGBR** Sofa / Divano / Canapé / Sofa
- CUARIDIV** Cushion / Cuscino
Coussin / Sitzpolster

TABLES / TAVOLI / TABLES / TISCHE

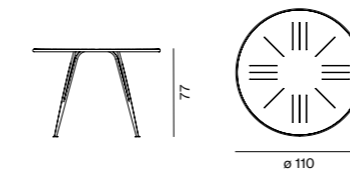

- ARITAVROBR** Round table / Tavolo rotondo
Table ronde / Runder Tisch

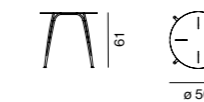

- ARITBROT** Round coffee table / Tavolo basso rotondo
Table basse ronde / Runder Couchtisch

FINISHES / FINITURE / FINITIONS / AUSFÜHRUNGEN

- Powder coated galvanized iron bronze
Ferro zincato verniciato a polveri bronzo
Fer galvanisé enduit de poudre bronze
Verzinktes, pulverbeschichtetes Eisen bronze
- Removable cushions Masterline Colour Collection p. 302
Cuscini sfoderabili Masterline Colour Collection pg. 302
Coussins déhoussables Masterline Colour Collection pg. 302
Abziehbare Kissen Masterline Kollektion Seite 302

- Powder coated galvanized iron / Ferro zincato verniciato a polveri / Fer galvanisé enduit de poudre / Verzinktes, pulverbeschichtetes Eisen
- Removable cushions col. standard Nuvola C01 / Cuscini sfoderabili col. standard Nuvola C01
Coussins déhoussables coul. standard Nuvola C01 / Abziehbare Kissen Standardfarbe Nuvola C01

Aurora

SITTING / SEDUTE / ASSISES / SITZMÖBEL

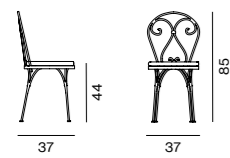

AUSN Chair / Sedia / Chaise / Stuhl
CUABA Cushion / Cuscino / Coussin / Kissen

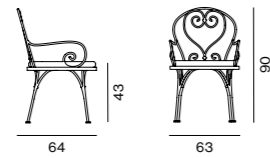

AUPOLG Small armchair / Poltroncina
Petit fauteuil / Armstuhl
CUPAUBA-S2 Cushion / Cuscino / Coussin / Kissen

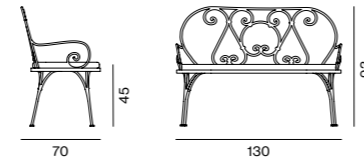

AUDIG Bench / Panchetta / Banc / Bank
CUDAUBA-S2 Cushion / Cuscino / Coussin / Kissen

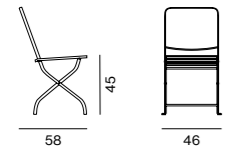

CESEG Chair / Sedia / Chaise / Stuhl
CUCEPSA Cushion / Cuscino / Coussin / Kissen

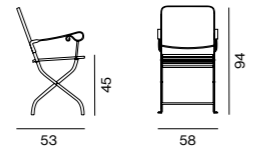

CEPOG Small armchair / Poltroncina
Petit fauteuil / Armstuhl
CUCEPSA Cushion / Cuscino / Coussin / Kissen

LOUNGE / LOUNGE / LOUNGE / LOUNGE

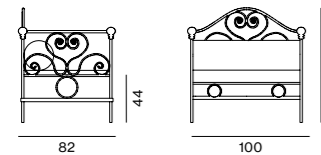

MORPOS Armchair / Poltrona / Fauteuil / Sessel
CUSMOPOA Cushion / Cuscino / Coussin / Polster

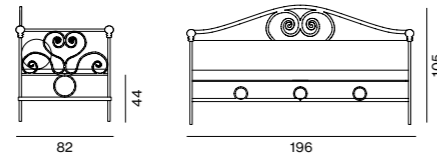

MORDIS Sofa / Divano / Canapé / Sofa
CUSMORA Cushion / Cuscino / Coussin / Polster

SUNLOUNGER / LETTINO / BAIN DE SOLEIL / SONNENLIEGE

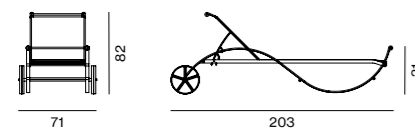

LELEGM Sunlounger / Lettino / Bain de soleil / Sonnenliege

TABLES / TAVOLI / TABLES / TISCHE

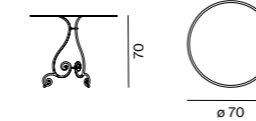

TALFG Round table / Tavolo rotondo
Table ronde / Runder Tisch

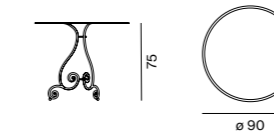

TALFG9 Round table / Tavolo rotondo
Table ronde / Runder Tisch

ACCESSORIES / ACCESSORI / ACCESSOIRES / ZUBEHÖR

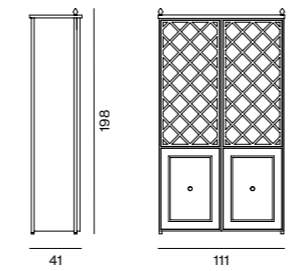

LARM Cupboard / Armadio / Armoire / Schrank

- Powder coated galvanized iron / Ferro zincato verniciato a polveri / Fer galvanisé enduit de poudre / Verzinktes, pulverbeschichtetes Eisen
- Removable cushions col. standard Latte 04 / Cuscini sfoderabili col. standard Latte 04 / Coussins déhoussables coul. standard Latte 04
Abziehbares Kissen in Standardfarbe 04 Latte
- Technical fabric / Tessuto tecnico / Tissu technique / technisches Gewebe

FINISHES / FINITURE / FINITIONS / AUSFÜHRUNGEN

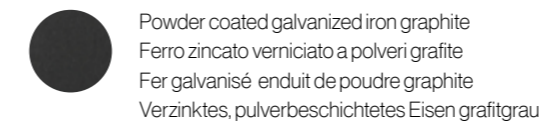

Powder coated galvanized iron graphite
Ferro zincato verniciato a polveri grafite
Fer galvanisé enduit de poudre graphite
Verzinktes, pulverbeschichtetes Eisen grafitgrau



Removable cushions Masterline Colour Collection p. 302
Cuscini sfoderabili Masterline Colour Collection pg. 302
Coussins déhoussables Masterline Colour Collection pg. 302
Abziehbare Kissen Masterline Kollektion Seite 302



Polycarbonate panels (LARM)
Pannelli policarbonato (LARM)
Polycarbonate panneaux (LARM)
Panneele aus Polycarbonat (LARM)



Technical fabric brown
Tessuto tecnico brown
Tissu technique brown
Technisches Gewebe braun

- Powder coated galvanized iron / Ferro zincato verniciato a polveri / Fer galvanisé enduit de poudre / Verzinktes, pulverbeschichtetes Eisen
- Removable cushions col. standard Latte 04 / Cuscini sfoderabili col. standard Latte 04 / Coussins déhoussables coul. standard Latte 04
Abziehbares Kissen in Standardfarbe 04 Latte
- Technical fabric / Tessuto tecnico / Tissu technique / technisches Gewebe

Capri

SITTING / SEDUTE / ASSISES / SITZMÖBEL

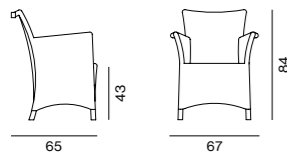

Small armchair / Poltroncina / Petit fauteuil / Armstuhl

CPPOBLW	Blue / Blu / Bleu / Blau
CPPOCEW	Sky blue / Azzurro / Bleu clair / Hellblau
CPPOGIW	Yellow / Giallo / Jaune / Gelb
CPPOPRW	Burgundy / Prugna / Prune / Pflaumenblau
CPPOROW	Red / Rosso / Rouge / Rot
CPPOVEW	Green / Verde / Vert / Grün

CPCUPO Cushion / Cuscino / Coussin / Kissen

FINISHES / FINITURE / FINITIONS / AUSFÜHRUNGEN



WaProLace® blue
WaProLace® blu
WaProLace® bleu
WaProLace® blau



WaProLace® sky blue
WaProLace® azzurro
WaProLace® bleu clair
WaProLace® hellblau



WaProLace® yellow
WaProLace® giallo
WaProLace® jaune
WaProLace® gelb



WaProLace® burgundy
WaProLace® prugna
WaProLace® prugne
WaProLace® pflaumenblau



WaProLace® red
WaProLace® rosso
WaProLace® rouge
WaProLace® rot



WaProLace® green
WaProLace® verde
WaProLace® vert
WaProLace® grün

Removable cushions Masterline Colour Collection pg. 302
Cuscini sfoderabili Masterline Colour Collection pg. 302
Coussins déhoussables Masterline Colour Collection pg. 302
Abziehbare Kissen aus der Masterline Kollektion Seite 302

→ Aluminum / Alluminio / Aluminium / Aluminium

→ WaProLace® synthetic fibre / Fibra sintetica WaProLace® / Fibre synthétique WaProLace® / WaProLace® Synthetikfaser

→ Removable cushions col. standard Nuvola C01 / Cuscini sfoderabili col. standard Nuvola C01
Coussins déhoussables coul. standard Nuvola C01 / Abziehbare Kissen Standardfarbe Nuvola C01

Clio

SITTING / SEDUTE / ASSISES / SITZMÖBEL

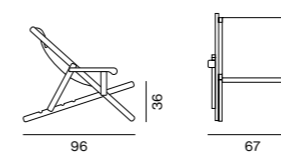

CLI	Deckchair with sling in 100% cotton Sdraio con telo di cotone 100% Transat avec toile 100% coton Liegestuhl mit Tuchbespannung aus Baumwolle
CLIOTEL	Spare sling / Telo di ricambio Toile de rechange / Ersatzbespannung

FINISHES / FINITURE / FINITIONS / AUSFÜHRUNGEN



Teak
Teak
Teck
Teakholz



Cotton off white
Cotone bianco
Coton blanc
Baumwolle naturfarben

→ Teak / Teak / Teck / Teakholz

→ Cotton off white / Cotone bianco / Coton blanc / Baumwolle naturfarben

C'est La Vie

LOUNGE / LOUNGE / LOUNGE / LOUNGE

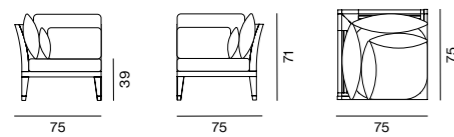

Corner Module / Modulo angolare / Module angulaire / Eckmodul

BOMOAN Structure / Struttura / Structure / Gestell
CUBOMOAN Cushion / Cuscino / Coussin / Polster

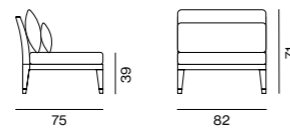

Backrest module / Modulo spalla / Module dossier / Rückenlehnmodul

BOMOSP Structure / Struttura / Structure / Gestell
CUBOMOSP Cushion / Cuscino / Coussin / Polster

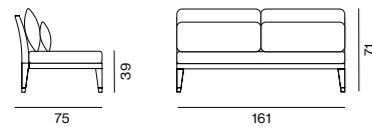

Sofa 2 seats / Divano 2 posti / Canapé 2 places / Zweisitzer Sofa

BOMODI2P Structure / Struttura / Structure / Gestell
CUBOMOSP Cushion / Cuscino / Coussin / Polster

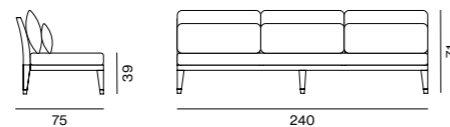

Sofa 3 seats / Divano 3 posti / Canapé 3 places / Dreisitzer Sofa

BOMODI3P Structure / Struttura / Structure / Gestell
CUBOMOSP Cushion / Cuscino / Polster

SUNLOUNGERS / LETTINI / BAINS DE SOLEIL / SONNENLIEGEN

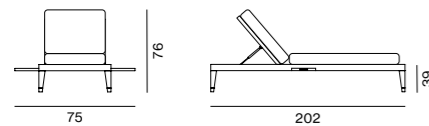

Sunlounger / Lettino / Bain de soleil / Sonnenliege

BOMOLES Structure / Struttura / Structure / Gestell
CUBOMOLES Cushion / Cuscino / Coussin / Polsterauflage

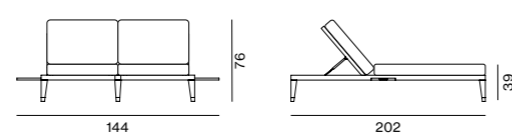

Double sunlounger / Lettino doppio / Bain de soleil double / doppelte Sonnenliege

BOMOLED Structure / Struttura / Structure / Gestell
CUBOMOLES Cushion / Cuscino / Coussin / Polsterauflage

TABLES / TAVOLI / TABLES / TISCHE

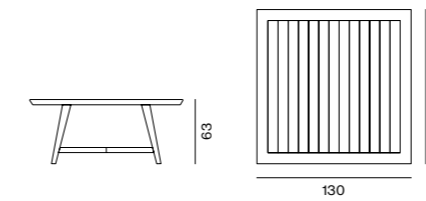

BOMOTAVQ Square table / Tavolo quadrato
 Table carrée / quadratischer Tisch

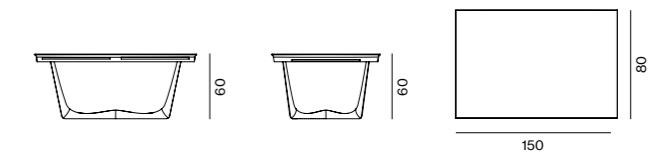

BOMOTF Rectangular table extractable tabletops
 Tavolo rettangolare piani estraibili
 Table rectangulaire avec étagères amovibles
 Rechteckiger Tisch mit ausziehbaren Tischplatten

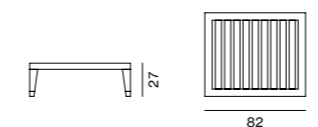

BOMOTB Rectangular coffee table
 Tavolo basso rettangolare
 Table basse rectangulaire
 Rechteckiger Couchtisch

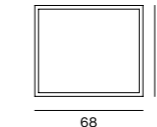

BOMOVA Tray / Vassoio / Plateau / Tablett

CUBOMOTB Cushion pouf / Cuscino pouf
 Coussin pouf / Polster für Couchtisch

FINISHES / FINITURE / FINITIONS / AUSFÜHRUNGEN

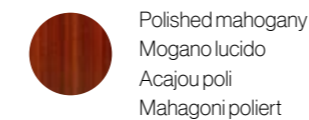

Polished mahogany
 Mogano lucido
 Acajou poli
 Mahagoni poliert



Removable cushions Masterline Colour Collection p. 302
 Cuscini sfoderabili Masterline Colour Collection pg. 302
 Coussins déhoussables Masterline Colour Collection pg. 302
 Abziehbare Polster Masterline Kollektion Seite 302

→ Polished mahogany / Mogano lucido / Acajou poli / Mahagoni poliert
 → Removable cushions col. standard Nuvola C01 / Cuscini sfoderabili col. standard Nuvola C01
 Coussins déhoussables coul. standard Nuvola C01 / Abziehbare Kissen Standardfarbe Nuvola C01

→ Polished mahogany / Mogano lucido / Acajou poli / Mahagoni poliert
 → Removable cushions col. standard Nuvola C01 / Cuscini sfoderabili col. standard Nuvola C01
 Coussins déhoussables coul. standard Nuvola C01 / Abziehbare Polster Standardfarbe Nuvola C01

Chelsea

SITTING / SEDUTE / ASSISES / SITZMÖBEL

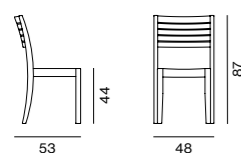

SEBRI Chair / Sedia / Chaise / Stuhl
CUSBRIA Cushion / Cuscino / Coussin / Kissen

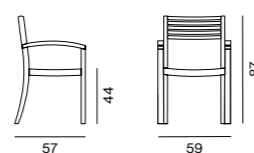

BRISE Small armchair / Poltroncina / Petit fauteuil / Armstuhl
CUSBRIA Cushion / Cuscino / Coussin / Kissen

SUNLOUNGER / LETTINO / BAIN DE SOLEIL / SONNENLIEGE

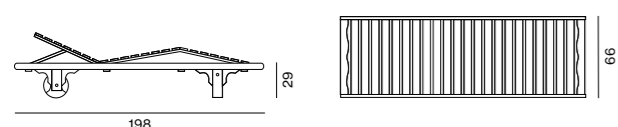

HENLETT Sunlounger / Lettino / Bain de soleil / Sonnenliege
CUHE Cushion / Cuscino / Coussin / Polsterauflage

LOUNGE / LOUNGE / LOUNGE / LOUNGE

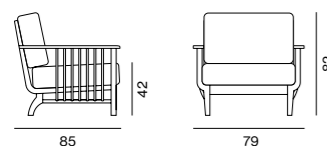

CHPO Armchair / Poltrona / Fauteuil / Sessel
CHCU Set of cushions / Set di cuscini
 Set de coussins / Polsterset

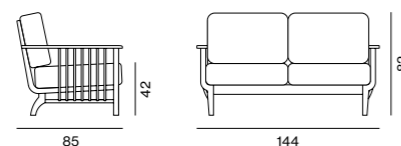

CHDIP 2-seater Sofa / Divano due posti
 Canapé 2 places / Zweisitzer Sofa
CHCU Set of cushions / Set di cuscini
 Set de coussins / Polsterset

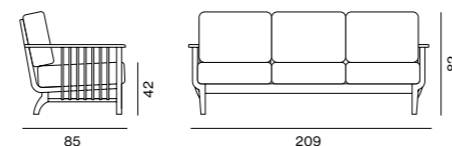

CHDIG 3-seater Sofa / Divano 3 posti
 Canapé 3 places / Dreisitzer Sofa
CHCU Set of cushions / Set di cuscini
 Set de coussins / Polsterset

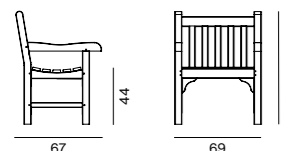

GRPOL Armchair / Poltrona / Fauteuil / Sessel
CUSPOLGRA Cushion / Cuscino / Coussin / Kissen

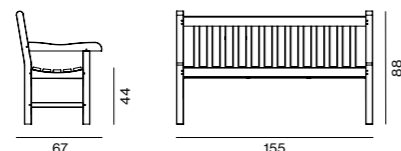

GRDIV15 2-seater Sofa / Divano due posti
 Canapé 2 places / Zweisitzer Sofa
CUDIV15A Set of 2 cushions / Set di 2 cuscini
 Set de 2 coussins / Set mit 2 Kissen

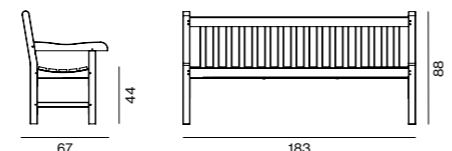

GRDIV18 3-seater Sofa / Divano 3 posti
 Canapé 3 places / Dreisitzer Sofa
CUDIV18A Set of 3 cushions / Set di 3 cuscini
 Set de 3 coussins / Set mit 3 Kissen

↳ Teak / Teak / Teck / Teakholz

↳ Removable cushions col. standard Latte 04 / Cuscini sfoderabili col. standard Latte 04 / Coussins déhoussables coul. standard Latte 04
 Abziehbare Kissen in Standardfarbe 04 Latte (not removable / non sfoderabili / non déhoussable / nicht abziehbar CUSBRIA - CUSPOLGRA
 CUDIV15A - CUDIV18A)

TABLES / TAVOLI / TABLES / TISCHE

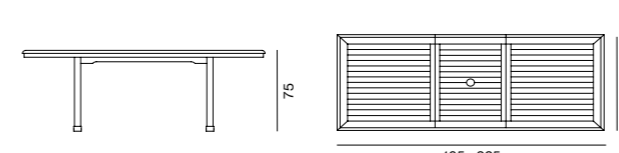

TAMIREP Table extendable / Tavolo allungabile
 Table allongeable / Ausziehbarer Tisch

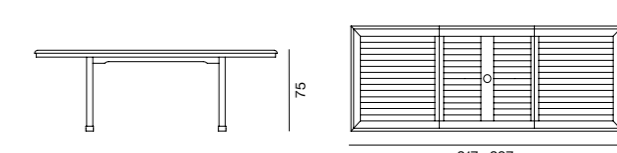

TAMILRE Table extendable / Tavolo allungabile
 Table allongeable / Ausziehbarer Tisch

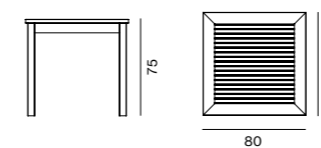

LOTAVQ Square table / Tavolo quadrato
 Table carrée / Quadratischer Tisch

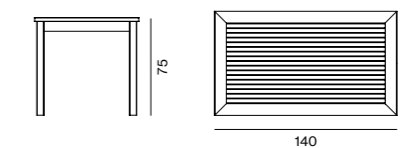

LOTAVR Rectangular table / Tavolo rettangolare
 Table rectangulaire / Rechteckiger Tisch

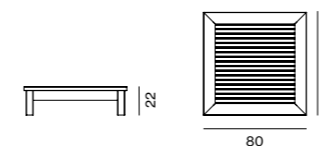

CHETAQ Square coffee table / Tavolo basso quadrato
 Table basse carrée / Quadratischer Couchtisch

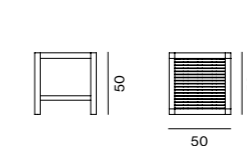

MOTAQB Square coffee table / Tavolo basso quadrato
 Table basse carrée / Quadratischer Couchtisch

CHEST / BAULE / COFFRE / TRUHE

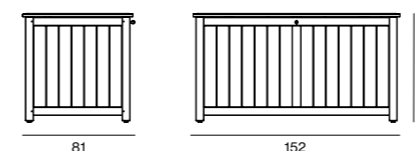

Chest / Baule / Coffre

BAUTWAT Assembly kit / In kit di montaggio
 En kit de montage / Im Bausatz

BAUTWAM Assembled / Assemblato
 Assemblé / Fertig montiert

↳ Teak / Teak / Teck / Teakholz

↳ Removable cushions col. standard Latte 04 / Cuscini sfoderabili col. standard Latte 04 / Coussins déhoussables coul. standard Latte 04
 Abziehbare Kissen in Standardfarbe 04 Latte (not removable / non sfoderabili / non déhoussable / nicht abziehbar CUSBRIA - CUSEDA
 CUSPOLGRA - CUDIV15A - CUDIV18A)

FINISHES / FINITURE / FINITIONS / AUSFÜHRUNGEN

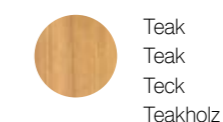

Removable cushions Masterline Colour Collection p. 302
 Cuscini sfoderabili Masterline Colour Collection pg. 302
 Coussins déhoussables Masterline Colour Collection pg. 302
 Abziehbare Polster Masterline Kollektion Seite 302

Coco

SITTING / SEDUTE / ASSISES / SITZMÖBEL

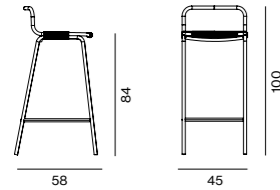

COSGAG Stool graphite with cord ecru / Sgabello grafite con corda ecru
Tabouret graphite avec corde ecru / Barhocker

TABLES / TAVOLI / TABLES / TISCHE

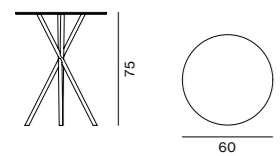

Round table / Tavolo rotondo
Table ronde / Runder Tisch

COTAVGR Graphite / Grafite
Graphite / Grafitgrau
COTAVSY Syrah
COTAVSA Sand / Sabbia
Sable / Sandfarben

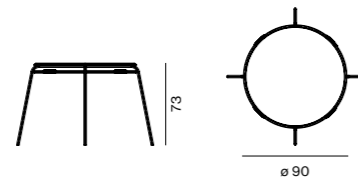

COTA90G Round table graphite
with cord ecru
Tavolo rotondo grafite
con corda ecru
Table ronde graphite
avec corde écru
Runder Tisch grafitgrau
und Seil ecru

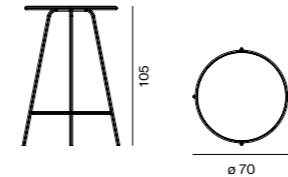

COTAL70G Round high table graphite
Tavolo alto rotondo grafite
Table haute ronde graphite
Runder, hoher Tisch grafitgrau

SUNLOUNGER / LETTINO / BAIN DE SOLEIL / SONNENLIEGE

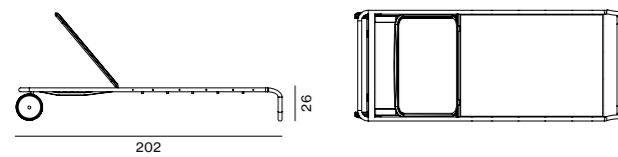

COLETG Sunlounger graphite with cord ecru / Lettino grafite con corda ecru
Bain de soleil graphite avec corde écru / Sonnenliege mit Seil in ecru
COLETUCU Cushion / Cuscino / Coussin / Polsterauflage

→ Powder coated galvanized iron / Ferro zincato verniciato a polveri / Fer galvanisé enduit de poudre / Verzinktes, pulverbeschichtetes Eisen grafitgrau
→ Polypropylene cord / Corda polipropilene / Corde en polypropylène / Polypropylen-Seil

SITTING AND LOUNGE / SEDUTE E LOUNGE / ASSISES ET LOUNGE / SITZGELGENHEITEN UND LOUNGEMÖBEL

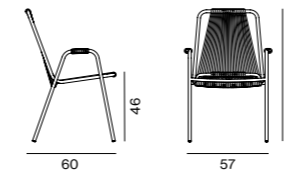

COSE Chair / Sedia / Chaise / Stuhl

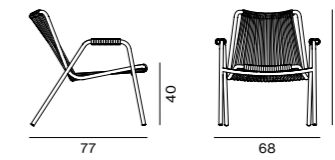

COPO Armchair / Poltrona / Fauteuil / Sessel

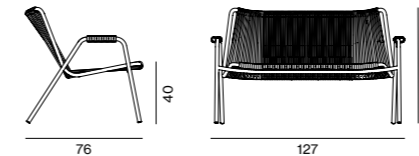

CODI Sofa / Divano / Canapé / Sofa

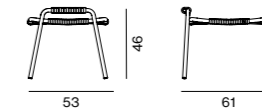

COPOG Footrest / Poggiapiedi
Repose pieds / Fußablage

STRUCTURE / STRUTTURA / STRUCTURE / GESTELL

GR - Graphite / Grafite / Graphite / Grafitgrau
SY - Syrah
SA - Sand / Sabbia / Sable / Sandfarben

CORD / CORDA / CORDE / SEIL

FO - Fondant / Fondente / Fondant / Fondant
EC - Ecrú
MA - Marsala

Complete the product item with the desired colour code by choosing from the combinations above (e.g. graphite chair and fondant cord = Art. COSE GRFO).

Completare l'articolo del prodotto con il codice colore desiderato scegliendo tra le combinazioni riportate sopra (es. sedia di colore grafite con corda fondante = Art. COSE GRFO).

Complétez l'article du produit avec le code couleur souhaité en choisissant parmi les combinaisons ci-dessus (par exemple, chaise graphite avec corde de couleur fondant = Art. COSE GRFO).

Vervollständigen Sie den Artikel mit dem gewünschten Farbcode aus den oben beschriebenen Kombinationen (z.B. Stuhl in Grafitgrau und Seile in der Farbe "fondant" = Art. COSE GRFO).

FINISHES / FINITURE / FINITIONS / AUSFÜHRUNGEN

Made to order / Su richiesta / Sur demande / Auf Anfrage

Graphite-coated iron
Ferro verniciato grafite
Fer galvanisé graphite
Beschichtetes Eisen grafitgrau

Polypropylene cord fondant
Corda polipropilene fondente
Corde polypropylène fondante
Polypropylen-Seil Farbe fondant

Sand coated iron
Ferro verniciato sabbia
Fer galvanisé sable
Beschichteter Stahl Farbe sand

Syrah-coated iron
Ferro verniciato syrah
Fer galvanisé syrah
Beschichtetes Eisen syrah

Polypropylene cord ecru
Corda polipropilene ecru
Corde polypropylène écru
Polypropylen-Seil Farbe ecru

Polypropylene cord marsala
Corda polipropilene marsala
Corde polypropylène marsala
Polypropylen-Seil Farbe marsala

→ Powder coated galvanized iron / Ferro zincato verniciato a polveri / Fer galvanisé enduit de poudre / Verzinktes, pulverbeschichtetes Eisen grafitgrau
→ Polypropylene cord / Corda polipropilene / Corde en polypropylène / Polypropylen-Seil

Conrad

SITTING / SEDUTE / ASSISES / SITZMÖBEL

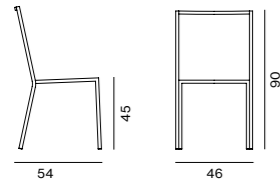

Chair / Sedia / Chaise / Stuhl

SELUB White / Bianco / Blanc / Weiß
SELUG Graphite / Grafite / Graphite / Grafitgrau
CUSELU Cushion / Cuscino / Coussin / Kissen

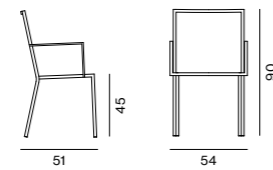

Small armchair / Poltroncina / Petit fauteuil / Armstuhl

POLUB White / Bianco / Blanc / Weiß
POLUG Graphite / Grafite / Graphite / Grafitgrau
CUSELU Cushion / Cuscino / Coussin / Kissen

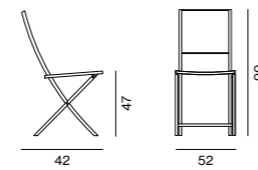

Chair / Sedia / Chaise / Stuhl

SENIB White / Bianco / Blanc / Weiß
SENIG Graphite / Grafite / Graphite / Grafitgrau
CUSENI Cushion / Cuscino / Coussin / Kissen

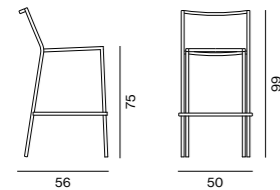

Stool / Sgabello / Tabouret / Barhocker

LUSGB White / Bianco / Blanc / Weiß
LUSGG Graphite / Grafite / Graphite / Grafitgrau

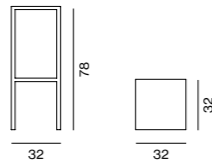

Stool / Sgabello / Tabouret / Barhocker

SGACON78B White / Bianco / Blanc / Weiß
SGACON78G Graphite / Grafite / Graphite / Grafitgrau

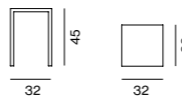

Stool / Sgabello / Tabouret / Hocker

SGACON45B White / Bianco / Blanc / Weiß
SGACON45G Graphite / Grafite / Graphite / Grafitgrau

TABLES / TAVOLI / TABLES / TISCHE

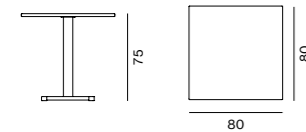

Square table / Tavolo quadrato
 Table carrée / Quadratischer Tisch

TACON80B White / Bianco / Blanc / Weiß
TACON80 Graphite / Grafite / Graphite / Grafitgrau

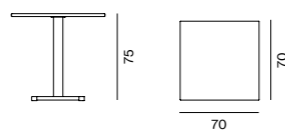

Square table / Tavolo quadrato
 Table carrée / Quadratischer Tisch

TACON70B White / Bianco / Blanc / Weiß
TACON70 Graphite / Grafite / Graphite / Grafitgrau

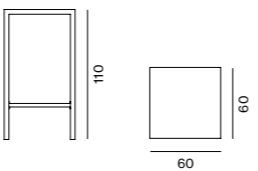

Square high table / Tavolo alto quadrato
 Table haute carrée / Quadratischer hoher Tisch

LUTLBQ White / Bianco / Blanc / Weiß
LUTLGQ Graphite / Grafite / Graphite / Grafitgrau

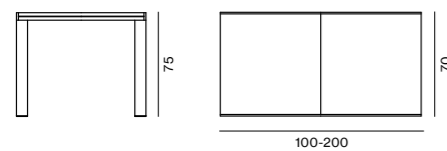

Rectangular extendable table / Tavolo allungabile rettangolare
 Table extensible rectangulaire / Rechteckiger Ausziehtisch

TACON100B White / Bianco / Blanc / Weiß
TACON100 Graphite / Grafite / Graphite / Grafitgrau

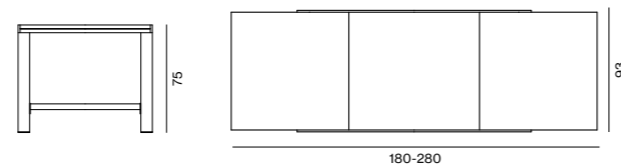

Rectangular extendable table / Tavolo allungabile rettangolare
 Table extensible rectangulaire / Rechteckiger Ausziehtisch

TACON180B White / Bianco / Blanc / Weiß
TACON180 Graphite / Grafite / Graphite / Grafitgrau

FINISHES / FINITURE / FINITIONS / AUSFÜHRUNGEN

● Powder coated galvanized iron graphite
 Ferro zincato verniciato a polveri grafite
 Fer galvanisé enduit de poudre graphite
 Verzinktes, pulverbeschichtetes Eisen grafitgrau

● Removable cushions col. Latte 04
 Cuscini sfoderabili col. Latte 04
 Coussins déhoussables coul. Latte 04
 Abziehbare Kissen in Standardfarbe 04 Latte

○ Powder coated galvanized iron white
 Ferro zincato verniciato a polveri bianco
 Fer galvanisé enduit de poudre blanc
 Verzinktes, pulverbeschichtetes Eisen weiß

→ Powder coated galvanized iron / Ferro zincato verniciato a polveri / Fer galvanisé enduit de poudre / Verzinktes, pulverbeschichtetes Eisen
 → Cushions col. standard Latte 04 / Cuscini col. standard Latte 04 / Coussins coul. standard Latte 04 / Kissen in Standardfarbe 04 Latte

→ Powder coated galvanized iron / Ferro zincato verniciato a polveri / Fer galvanisé enduit de poudre / Verzinktes, pulverbeschichtetes Eisen
 → Cushions col. standard Latte 04 / Cuscini col. standard Latte 04 / Coussins coul. standard Latte 04 / Kissen in Standardfarbe 04 Latte

Cosette

SITTING / SEDUTE / ASSISES / SITZMÖBEL

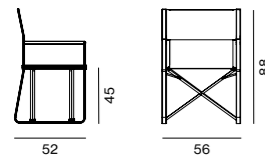

Small armchair in aluminium / Poltroncina in alluminio
 Petit fauteuil en aluminium / Armstuhl aus Aluminium

OCPOLB White structure / Struttura in bianco
 Structure en Blanc / Weißes Gestell

OCPOLG Graphite structure / Struttura in Grafite
 Structure en Graphite / Grafitgraues Gestell

OCTELB Cover hemp white / Telo bianco canapa
 Toile blanc chanvre / Bespannung naturweiß

OCTELBR Cover brown / Telo brown
 Toile marron / Bespannung braun

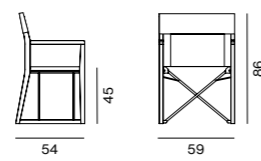

Small armchair in teak / Poltroncina in teak
 Petit fauteuil en teck / Armstuhl aus Teakholz

COPOL Structure / Struttura / Structure / Gestell

COPOLT Cover dove grey / Telo tortora
 Toile tourterelle / Bespannung taubengrau

COPOLB Cover hemp white / Telo bianco canapa
 Toile blanc chanvre / Bespannung naturweiß

COPOLM Cover brown / Telo brown
 Toile marron / Bespannung braun

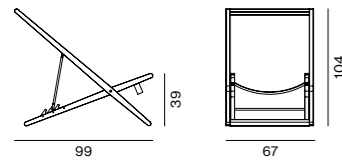

Deckchair / Sdraio in teak / Transat en teck / Liegestuhl aus Teakholz

SDCOST Structure / Struttura / Structure / Gestell

TELCOSTO Dove grey polypropylene fabric / Tessuto polipropilene tortora
 Tissu polypropylène taupe / Taubengrauer Stoff aus Polypropylen

TELCOSBC Sling hemp white / Telo bianco canapa
 Toile blanc chanvre / Bespannung naturweiß

TELCOSBM Sling brown / Telo brown
 Toile marron / Bespannung braun

TABLE / TAVOLO / TABLE / TISCH

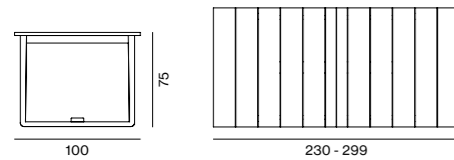

COTARE Rectangular table / Tavolo rettangolare / Table rectangulaire / Rechteckiger Tisch

FINISHES / FINITURE / FINITIONS / AUSFÜHRUNGEN



Teak
 Teak
 Teck
 Teakholz



Aluminum graphite
 Alluminio grafite
 Aluminium graphite
 Aluminium grafitgrau

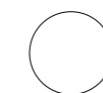

Aluminum white
 Alluminio bianco
 Aluminium blanc
 Aluminium weiß



Brown technical fabric
 Tessuto tecnico brown
 Tissu technique en marron
 Technisches Gewebe braun



Hemp white technical fabric
 Tessuto tecnico bianco canapa
 Tissu technique blanc chanvre
 Technisches Gewebe naturweiß



Dove grey polypropylene fabric
 Tessuto polipropilene tortora
 Tissu polypropylène taupe
 Taubengrauer Stoff aus Polypropylen

- ↳ Teak / Teak / Teck / Teakholz
- ↳ Aluminum / Alluminio / Aluminium / Aluminium
- ↳ Technical fabric / Tessuto tecnico / Tissu technique / technisches Gewebe
- ↳ Polypropylene fabric / Tessuto polipropilene / Tissu polypropylène / Polypropylen Stoff

Davos

SITTING AND LOUNGE / SEDUTA E LOUNGE / LOUNGEMÖBEL

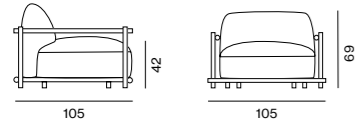

Armchair / Poltrona / Fauteuil / Sessel

NUPOLG Fabric upholstery / Cuscineria in tessuto
Coussins en tissu / Polster mit Stoffbezug

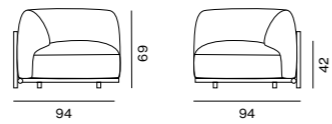

Corner Module / Modulo angolare
Module angulaire / Eckmodul

NUANGOLG Fabric upholstery / Cuscineria in tessuto
Coussins en tissu / Polster mit Stoffbezug

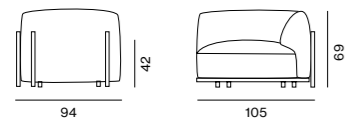

L End module / Modulo finale sx
Module terminal g / Endmodul links

NUFINGS Fabric upholstery / Cuscineria in tessuto
Coussins en tissu / Polster mit Stoffbezug

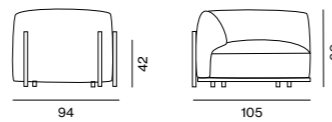

R end module / Modulo finale dx
Module terminal d / Endmodul rechts

NUFINGD Fabric upholstery / Cuscineria in tessuto
Coussins en tissu / Polster mit Stoffbezug

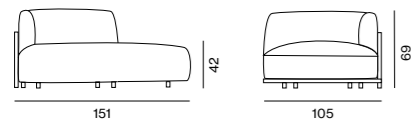

L lounge module / Modulo lounge sx
Module lounge g / Loungemodul links

NULOUGS Fabric upholstery / Cuscineria in tessuto
Coussins en tissu / Polster mit Stoffbezug

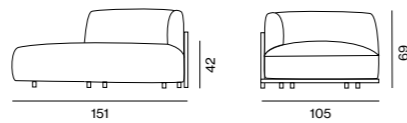

R Lounge module / Modulo lounge dx
Module lounge d / Loungemodul rechts

NULOUGD Fabric upholstery / Cuscineria in tessuto
Coussins en tissu / Polster mit Stoffbezug

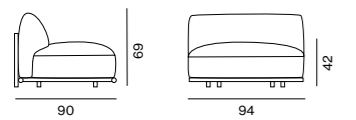

Backrest module / Modulo spalla
Module dossier / Rückenlehnmodul

NUSPAG Fabric upholstery / Cuscineria in tessuto
Coussins en tissu / Polster mit Stoffbezug

- Aluminum / Alluminio / Aluminium / Aluminium
- Porcelain stone ware / Gres porcellanato / Grès cérame / Feinsteinzeug
- Removable cushions col. standard Nuvola C01 / Cuscini sfoderabili col. standard Nuvola C01 / Coussins déhoussables coul. standard Novola C01 / Abziehbare Polster Standardfarbe Nuvola C01

TABLES / TAVOLI / TABLES / TISCHE

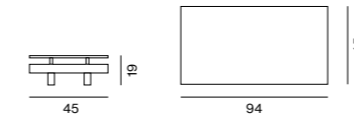

NUTACEG Rectangular coffee table module
Modulo tavolo basso rettangolare
Module table basse rectangulaire
Rechteckiges Couchtisch-Modul

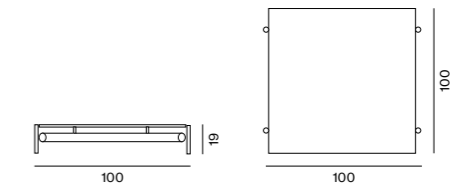

NUTABG Square coffee table
Tavolo basso quadrato
Table basse carrée
Quadratischer Couchtisch

FINISHES / FINITURE / FINITIONS / AUSFÜHRUNGEN

Aluminum graphite
Alluminio grafite
Aluminium graphite
Aluminium grafitgrau

Porcelain stoneware
Gres porcellanato
Grès cérame
Feinsteinzeug

Removable cushions Masterline Colour Collection p. 302
Cuscini sfoderabili Masterline Colour Collection pg. 302
Coussins déhoussables Masterline Colour Collection pg. 302
Abziehbare Polster aus der Masterline Kollektion Seite 302

Emy

SITTING / SEDUTE / ASSISES / SITZMÖBEL

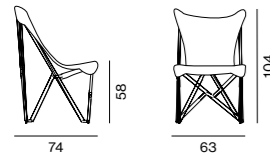

Small armchair / Poltroncina / Petit fauteuil / Armstuhl

EMY	Structure / Struttura / Structure / Gestell
EMYTEL	Sling in 100% cotton / Telo di cotone 100% / Toile 100% coton / Bespannung aus 100% Baumwolle
EMYTPA	Sling in orange leather / Telo di pelle arancio / Toile en cuir orange / Bespannung aus orangem Leder
EMYTPV	Sling in green leather / Telo di pelle verde / Toile en cuir vert / Bespannung aus grünem Leder

Leather slings not suitable for outdoor use / Teli in pelle non indicati per uso esterno
Toiles en cuir non indiquées pour usage externe / Leder nicht für den Außenbereich geeignet

FINISHES / FINITURE / FINITIONS / AUSFÜHRUNGEN

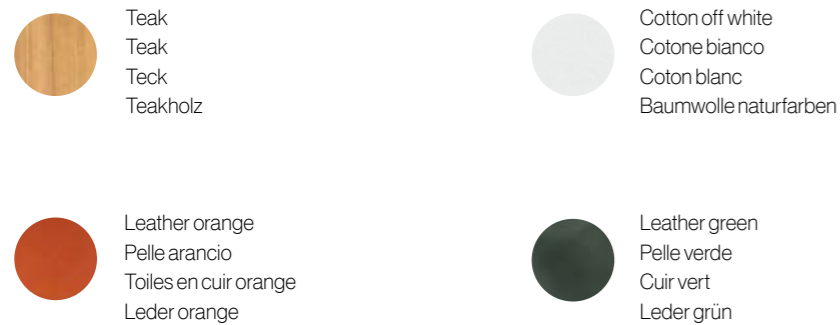

- Teak / Teak / Teck / Teakholz
- Cotton off white / Cotone bianco grezzo / Coton blanc / Baumwolle naturfarben
- Sling in leather / Telo di pelle / Toiles en cuir / Bespannung aus Leder / Bespannung aus Leder

Experience

SITTING / SEDUTE / ASSISES / SITZMÖBEL

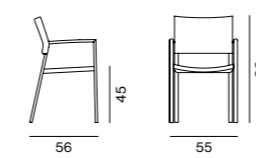

JOSEG Chair / Sedia / Chaise / Stuhl

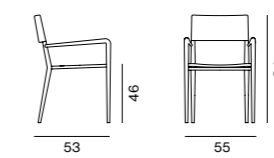

EXLSEI Small armchair / Poltroncina
Petit fauteuil / Armstuhl

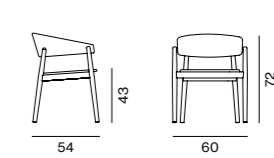

EXLPOGW Small armchair / Poltroncina
Petit fauteuil / Armstuhl

LOUNGE / LOUNGE / LOUNGE / LOUNGE

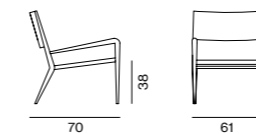

EXLPO Armchair / Poltrona
Fauteuil / Sessel

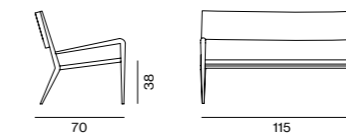

EXLDIV Sofa / Divano / Canapé / Sofa

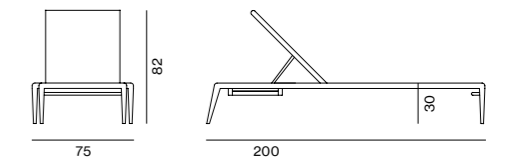

EXLET Sunlounger / Lettino
Bain de soleil / Sonnenliege
CUEXLET001 Cushion / Cuscino
Coussin / Polsterauflage

TABLES / TAVOLI / TABLES / TISCHE

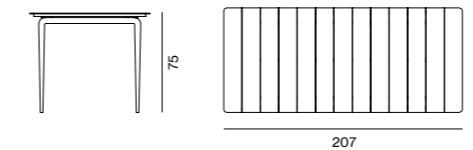

EXLTAVA Rectangular table
Tavolo rettangolare
Table rectangulaire
Rechteckiger Tisch

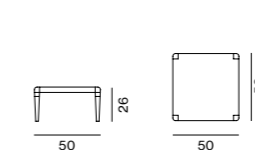

EXTALQ Square coffee table
Tavolo basso quadrato
Table basse carrée
Quadratischer Couchtisch

FINISHES / FINITURE / FINITIONS / AUSFÜHRUNGEN

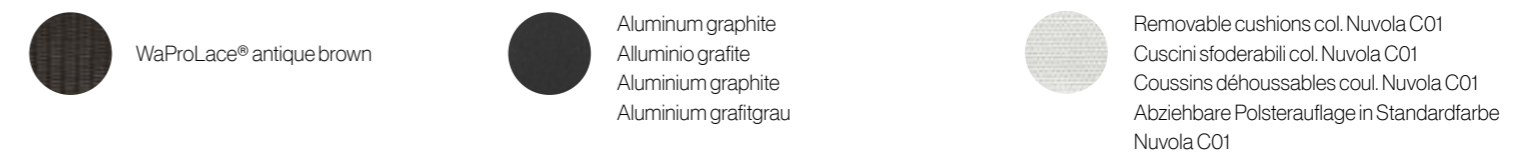

- Aluminum / Alluminio / Aluminium / Aluminium
- WaProLace® synthetic fibre / Fibra sintetica WaProLace® / Fibre synthétique WaProLace® / WaProLace® Synthetikfaser
- Removable cushions col. standard Nuvola C01 / Cuscini sfoderabili col. standard Nuvola C01
Coussins déhoussables coul. standard Nuvola C01 / Abziehbare Polsterauflage Standardfarbe Nuvola C01

Fresbee

TABLES / TAVOLI / TABLES / TISCHE

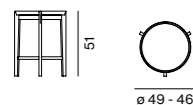

Round coffee table / Tavolo basso rotondo
Table basse ronde / Runder Beistelltisch

FRIPINAL Aluminum structure - aluminum tray
Struttura in alluminio - vassoio in alluminio
Structure en aluminium - plateau en aluminium
Gestell aus Aluminium - Tablett aus Aluminium

FRIPINT Teak structure - aluminum tray
Struttura in teak - vassoio in alluminio
Structure en teck - plateau en aluminium
Gestell aus Teakholz - Tablett aus Aluminium

FINISHES / FINITURE / FINITIONS / AUSFÜHRUNGEN

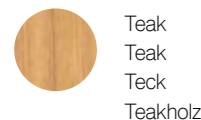

Teak
Teak
Teck
Teakholz



Aluminum graphite
Alluminio grafite
Aluminium graphite
Aluminium grafitgrau

→ Teak / Teak / Teck / Teakholz
→ Aluminum / Alluminio/ Aluminium / Aluminium

Ginger

SITTING / SEDUTE / ASSISES / SITZMÖBEL

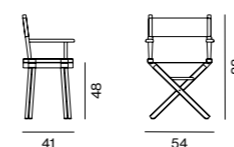

Small armchair / Poltroncina / Petit fauteuil / Armstuhl

GINPOST Structure / Struttura / Structure / Gestell
GINTEL Cover and cushion in 100% cotton
Teli e cuscino di cotone 100%
Toiles et coussin 100% coton
Bespannung und Sitzkissen aus 100% Baumwolle

GITECAN Cover Batyline Serge Ferrari beige
Telo Batyline Serge Ferrari beige
Toile en Batyline Serge Ferrari beige
Bespannung aus Batyline Serge Ferrari Farbe beige

GINTEXBI Cover quilted plastic fabric white
Telo di tessuto plastico trapuntato bianco
Toiles en tissu plastique matelassé blanc
Bespannung aus aus gestepptem, weißem Kunststoff

GINTBAVO Cover Batyline Serge Ferrari green
Telo Batyline Serge Ferrari verde
Toile en Batyline Serge Ferrari vert
Bespannung aus Batyline Serge Ferrari Farbe grün

FINISHES / FINITURE / FINITIONS / AUSFÜHRUNGEN



Teak
Teak
Teck
Teakholz



Cotton off white (GINTEL)
Cotone bianco (GINTEL)
Coton blanc (GINTEL)
Baumwolle naturfarben (GINTEL)



Cover and cushion Masterline Colour Collection pg. 302
Teli e cuscino Masterline Colour Collection pg. 302
Toiles et coussin Masterline Colour Collection pg. 302
Bespannung und Sitzkissen Masterline Colour Collection Seite 302



Batyline Serge Ferrari beige (GITECAN)
Batyline Serge Ferrari beige (GITECAN)
Batyline Serge Ferrari beige (GITECAN)
Batyline Serge Ferrari beige (GITECAN)



Batyline Serge Ferrari green (GINTBAVO)
Batyline Serge Ferrari verde (GINTBAVO)
Batyline Serge Ferrari vert (GINTBAVO)
Batyline Serge Ferrari grün (GINTBAVO)



Plastic fabric white (GINTEXBI)
Tessuto plastico trapuntato bianco (GINTEXBI)
Tissu plastique matelassé blanc (GINTEXBI)
Kunststoffgewebe Weiß (GINTEXBI)

→ Teak / Teak / Teck / Teakholz
→ Cotton off white / Cotone bianco grezzo / Coton blanc / Baumwolle naturfarben
→ Batyline Serge Ferrari / Batyline Serge Ferrari / Batyline Serge Ferrari / Batyline Serge Ferrari
→ Plastic fabric / Tessuto plastico / Tissu plastique / Kunststoffgewebe

Luce

SITTING AND LOUNGE / SEDUTE E LOUNGE / ASSISES ET LOUNGE / SITZ- UND LOUNGEMÖBEL

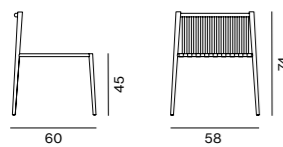

Chair / Sedia / Chaise / Stuhl

- LUNSB** Ivory white / Bianco avorio
Blanc ivoire / Elfenbeinfarben
LUNSBG Graphite / Grafite / Graphite / Grafitgrau
LUCUSB Cushion / Cuscino / Coussin / Kissen

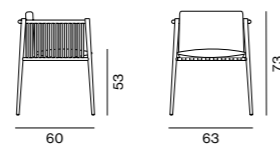

Small armchair / Poltroncina / Petit fauteuil / Armstuhl

- LUNSE** Ivory white / Bianco avorio
Blanc ivoire / Elfenbeinfarben
LUNSEG Graphite / Grafite / Graphite / Grafitgrau
LUCUSE Cushion / Cuscino / Coussin / Kissen

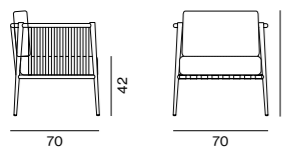

Armchair / Poltrona / Fauteuil / Sessel

- LUNPOB** Ivory white / Bianco avorio
Blanc ivoire / Elfenbeinfarben
LUNPOG Graphite / Grafite / Graphite / Grafitgrau
LUCUPO Cushion / Cuscino / Coussin / Polster

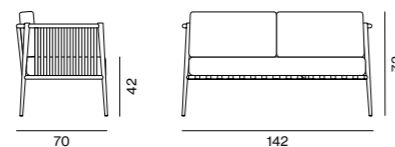

Sofa / Divano / Canapé / Sofa

- LUNDIB** Ivory white / Bianco avorio
Blanc ivoire / Elfenbeinfarben
LUNDIG Graphite / Grafite / Graphite / Grafitgrau
LUCUDI Cushion / Cuscino / Coussin / Polster

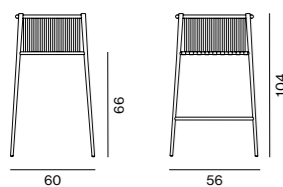

Stool / Sgabello / Tabouret / Barhocker

- LUNSGAB** Ivory white / Bianco avorio
Blanc ivoire / Elfenbeinfarben
LUNSGAG Graphite / Grafite / Graphite / Grafitgrau
LUCUSGA Cushion / Cuscino / Coussin / Kissen

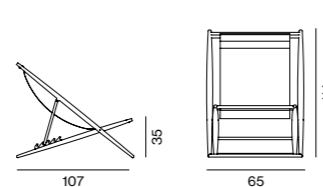

LUSDRB

- White deckchair with sling ecru
Sdraio bianca con telo ecru
Transat blanc avec toile écru
Elfenbeinfarbener Liegestuhl mit Bespannung ecru
LUSDRG Graphite deckchair with sling antracite
Sdraio grafite con telo antracite
Transat graphote avec toile anthracite
Grafitgrauer Liegestuhl mit Bespannung anthrazitfarben

TABLES / TAVOLI / TABLES / TISCHE

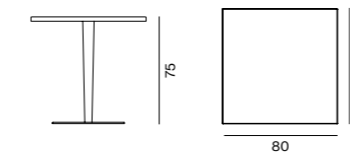

Square table / Tavolo quadrato / Table carrée / Quadratischer Tisch

- LUNTAQU80B** Ivory white / Bianco avorio / Blanc ivoire / Elfenbeinfarben
LUNTAQU80G Graphite / Grafite / Graphite / Grafitgrau

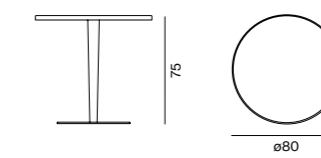

Round table / Tavolo rotondo / Table ronde / Runder Tisch

- LUNTARO80B** Ivory white / Bianco avorio / Blanc ivoire / Elfenbeinfarben
LUNTARO80G Graphite / Grafite / Graphite / Grafitgrau

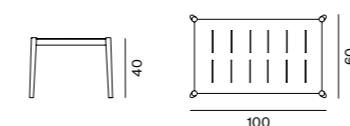

Rectangular coffee table / Tavolo basso rettangolare
Table basse rectangulaire / Rechteckiger Couchtisch

- LUNTBRR** Ivory white / Bianco avorio / Blanc ivoire / Elfenbeinfarben
LUNTBRRG Graphite / Grafite / Graphite / Grafitgrau

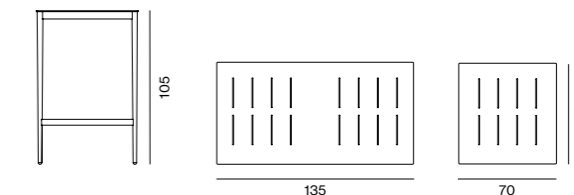

Tall table rectangular / Tavolo alto rettangolare
Table haute rectangulaire / Rechteckiger hoher Tisch

- LUNTABAREB** Ivory white / Bianco avorio / Blanc ivoire / Elfenbeinfarben
LUNTABAREG Graphite / Grafite / Graphite / Grafitgrau

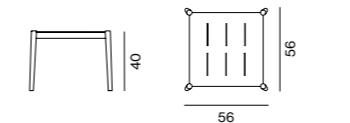

Square coffee table / Tavolo basso quadrato
Table basse carrée / Quadratischer Couchtisch

- LUNTBQB** Ivory white / Bianco avorio / Blanc ivoire / Elfenbein
LUNTBQG Graphite / Grafite / Graphite / Grafitgrau

Tall table square / Tavolo alto quadrato
Table haute carrée / Quadratischer hoher Tisch

- LUNTABAQUB** Ivory white / Bianco avorio / Blanc ivoire / Elfenbeinfarben
LUNTABAQUG Graphite / Grafite / Graphite / Grafitgrau

FINISHES / FINITURE / FINITIONS / AUSFÜHRUNGEN

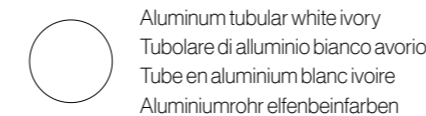

Aluminum tubular white ivory
Tubolare di alluminio bianco avorio
Tube en aluminium blanc ivoire
Aluminiumrohr elfenbeinfarben

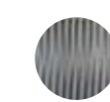

Melange sand polyolefin cord
Corda poliolefinica sabbia mélange
Cordon polyoléfine sable chiné
Polyolefin-Seil Farbe sand - meliert



Removable cushions Masterline Colour
Collection p.302
Cuscini sfoderabili Masterline Colour
Collection pg.302
Coussins déhoussables Masterline Colour
Collection pg.302
Abziehbare Kissen Masterline Kollektion
Seite 302



Aluminum tubular graphite
Tubolare di alluminio grafite
Tube en aluminium graphite
Aluminiumrohr Grafitgrau

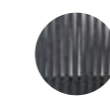

Melange charcoal grey polyolefin cord
Corda poliolefinica grigio carbone mélange
Cordon polyoléfine gris anthracite chiné
Polyolefin-Seil Farbe anthrazitgrau - meliert

→ Aluminum tubular / Tube di alluminio / Tubulaire en aluminium / Aluminiumrohr
→ Polyolefin cord / Corda poliolefinica / Cordon polyoléfine / Polyolefin Seil
→ Removable cushions col. standard Latte 04 / Cuscini sfoderabili col. standard Latte 04 / Coussins déhoussables coul. standard Latte 04
Abziehbare Polster in Standardfarbe 04 Latte

→ Aluminum tubular / Tube di alluminio / Tubulaire en aluminium / Aluminiumrohr
→ Polyolefin cord / Corda poliolefinica / Cordon polyoléfine / Polyolefin-Seil
→ Removable cushions col. standard Latte 04 / Cuscini sfoderabili col. standard Latte 04 / Coussins déhoussables coul. standard Latte 04
Abziehbare Polster in Standardfarbe 04 Latte

Lulù

SITTING / SEDUTE / ASSISES / SITZMÖBEL

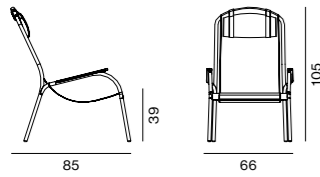

LULUPOG Armchair / Poltrona / Fauteuil / Sessel

FINISHES / FINITURE / FINITIONS / AUSFÜHRUNGEN

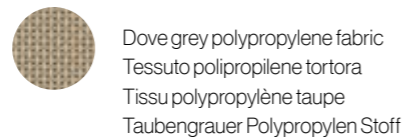
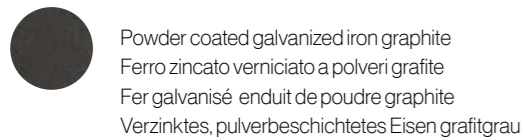

- Powder coated galvanized iron graphite / Ferro zincato verniciato a polveri grafite / Fer galvanisé enduit de poudre graphite
Verzinktes, pulverbeschichtetes Eisen grafitgrau
- Dove grey polypropylene fabric / Tessuto polipropilene tortora / Tissu polypropylène taupe / Taubengrauer Polypropylen Stoff

Nacre

SITTING / SEDUTE / ASSISES / SITZMÖBEL

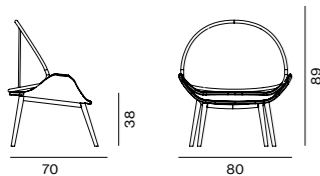

NASEDGR Armchair / Poltrona / Fauteuil / Sessel

FINISHES / FINITURE / FINITIONS / AUSFÜHRUNGEN

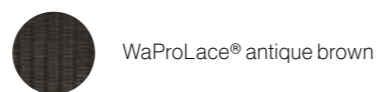

- Aluminum / Alluminio / Aluminium / Aluminium
- WaProLace® synthetic fibre / Fibra sintetica WaProLace® / Fibre synthétique WaProLace® / WaProLace® Synthetikfaser

Nanda

SITTING / SEDUTE / ASSISES / SITZMÖBEL

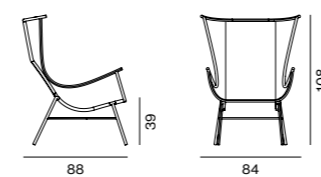

Bergère / Bergère / Bergère / Bergère

- NANPOGT** Graphite with Brick red fabric / Grafite con telo mattone
Graphite avec tissu brique / Grafitgrau mit ziegelroter Bespannung
- NANPOB** Sand with sand sling / Sabbia con telo sabbia
Sable avec tissu sable / Sandfarbe mit sandfarbener Bespannung

FINISHES / FINITURE / FINITIONS / AUSFÜHRUNGEN

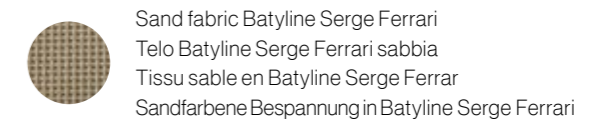
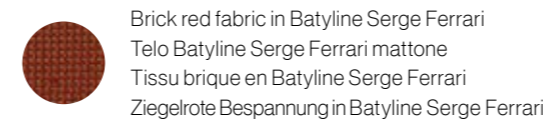
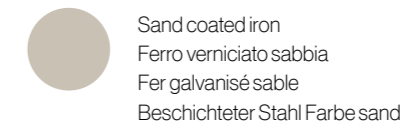
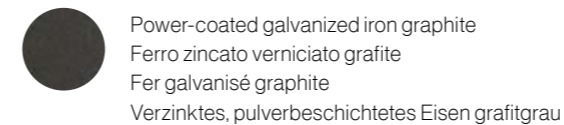

- Powder coated galvanized iron graphite / Ferro zincato verniciato a polveri grafite / Fer galvanisé enduit de poudre graphite
Verzinktes, pulverbeschichtetes Eisen grafitgrau
- Fabric in Batyline Serge Ferrari / Telo in Batyline Serge Ferrari / Tissu en Batyline Serge Ferrari / Bespannung en Batyline Serge Ferrari

Olimpia

LOUNGE / LOUNGE / LOUNGE / LOUNGE

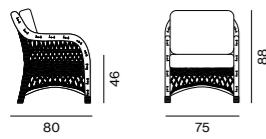

OLPOLW Armchair / Poltrona
Fauteuil / Sessel
OLCUPO Cushion / Cuscino
Coussin / Polster

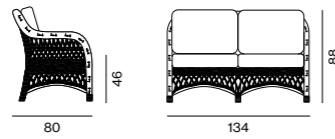

OLDIW2P Sofa / Divano
Canapé / Sofa
OLCUDI2P Cushion / Cuscino
Coussin / Polster

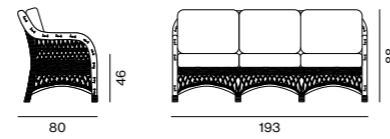

OLDIW3P Sofa / Divano
Canapé / Sofa
OLCUDI3P Cushion / Cuscino
Coussin / Polster

COFFEE TABLE / TAVOLO BASSO / TABLE BASSE / COUCHTISCH

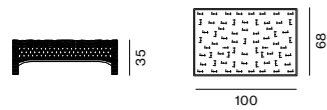

TABREOL Rectangular coffee table
Tavolo basso rettangolare
Table basse rectangulaire
Rechteckiger Couchtisch

FINISHES / FINITURE / FINITIONS / AUSFÜHRUNGEN



WaProLace® synthetic fibre
Fibra sintetica WaProLace®
Fibre synthétique WaProLace®
WaProLace® Synthetikfaser



Removable cushions Masterline Colour Collection p. 302
Cuscini sfoderabili Masterline Colour Collection pg. 302
Coussins déhoussables Masterline Colour Collection pg. 302
Abziehbare Polster Masterline Kollektion Seite 302

- Aluminum / Alluminio / Aluminium / Aluminium
- WaProLace® synthetic fibre / Fibra sintetica WaProLace® / Fibre synthétique WaProLace® / WaProLace® Synthetikfaser
- Removable cushions col. standard Latte 04 / Cuscini sfoderabili col. standard Latte 04 / Coussins déhoussables coul. standard Latte 04
- Abziehbares Polster in Standardfarbe 04 Latte

Panarea

SUNLOUNGERS / LETTINI / BAINS DE SOLEIL / SONNENLIEGEN

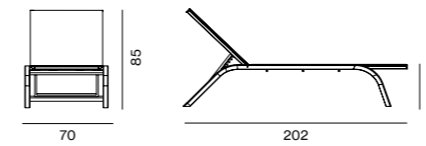

Sunlounger / Lettino / Bain de soleil / Sonnenliege

PANLEBB White / Bianco / Blanc / Weiß
PANLEGRM Graphite / Grafite / Graphite / Grafitgrau

TABLES / TAVOLI / TABLES / TISCHE

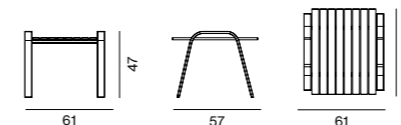

Coffee table / Tavolo basso / Table basse / Couchtisch

PANTBBI White / Bianco / Blanc / Weiß
PANTBGR Graphite / Grafite / Graphite / Grafitgrau

FINISHES / FINITURE / FINITIONS / AUSFÜHRUNGEN



Aluminum white
Alluminio bianco
Aluminium blanc
Aluminium weiß



Aluminum graphite
Alluminio grafite
Aluminium graphite
Aluminium grafitgrau



Hemp white technical fabric
Tessuto tecnico bianco canapa
Tissu technique blanc chanvre
Technisches Gewebe naturweiß



Brown technical fabric
Tessuto tecnico brown
Tissu technique en marron
Technisches Gewebe braun

- Aluminum / Alluminio / aluminium / Aluminium

Pevero

SITTING / SEDUTE / ASSISES / SITZMÖBEL

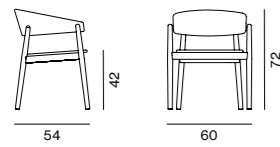

PEVSETC Small armchair in teak and cord
Poltroncina in teak e corda
Petit fauteuil en teck et corde
Armstuhl aus Teak und Seil

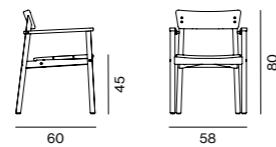

PEVSETE Small armchair / Poltroncina
Petit fauteuil / Armstuhl
CUPEVSE Cushion / Cuscino / Coussin / Kissen

LOUNGE / LOUNGE / LOUNGE / LOUNGE

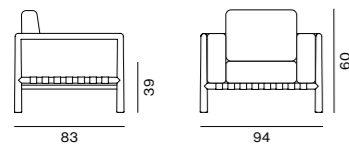

PEVPOL Armchair / Poltrona / Fauteuil / Sessel
CUPEVPOL Cushion / Cuscino / Coussin / Polster

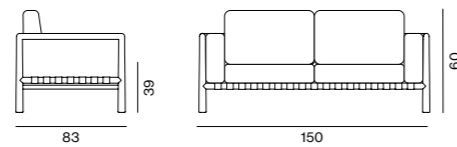

PEVDI2P 2-seater sofa / Divano 2 posti
Canapé 2 places / Zweisitzer Sofa
CUPEVDI2P Set of cushions / Set di cuscini
Set de coussins / Polsterset

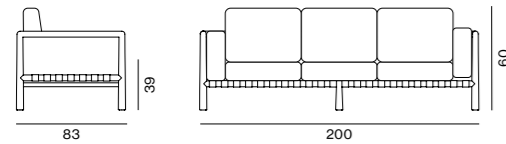

PEVDI3P 3-seater sofa / Divano 3 posti / Canapé 3 places / Dreisitzer Sofa
CUPEVDI3P Set of cushions / Set di cuscini / Set de coussins / Polsterset

SUNLOUNGER / LETTINO / BAIN DE SOLEIL / SONNENLIEGE

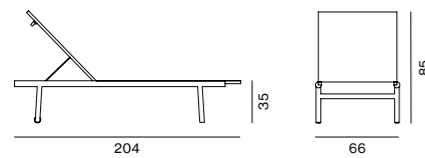

PEVLET Sunlounger / Lettino
Bain de soleil / Sonnenliege

- Teak / Teak / Teck / Teakholz
- Removable cushions col. standard Nuvola C01 / Cuscini sfoderabili col. standard Nuvola C01
Coussins déhoussables coul. standard Nuvola C01 / Abziehbare Polster Standardfarbe Nuvola C01

ISLAND / ISOLA / ÎLOT / SONNENINSEL

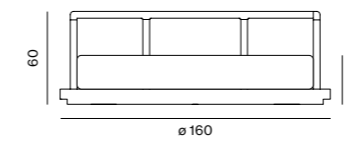

PEVISO Island / Isola / Îlot / Sonneninsel
CUPEVISO Cushion / Cuscino / Coussin / Polster

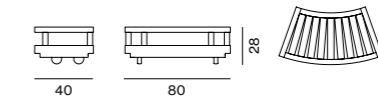

PEVISOTB Island table / Tavolo basso
Table basse / Beistelltisch für Insel

TABLES / TAVOLI / TABLES / TISCHE

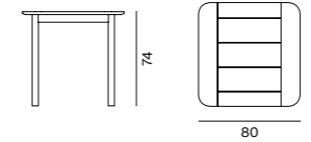

PEVTAQ80 Square table
Tavolo quadrato
Table carrée
Quadratischer Tisch

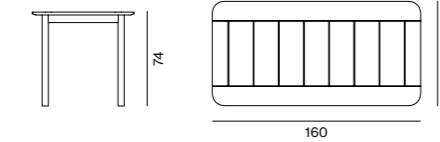

PEVTARE160 Rectangular table
Tavolo rettangolare
Table rectangulaire
Rechteckiger Tisch

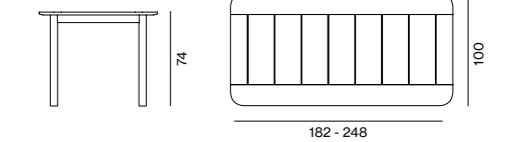

PETAREAL Rectangular table
Tavolo rettangolare
Table rectangulaire
Rechteckiger Tisch

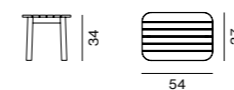

PEVSTAB Rectangular coffee table
Tavolo basso rettangolare
Table basse rectangulaire
Rechteckiger Couchtisch

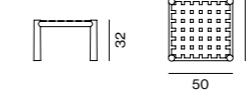

PEVTBQ Square coffee table
Tavolo basso quadrato
Table basse carrée
Quadratischer Couchtisch

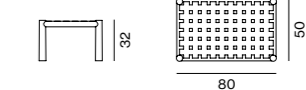

PEVTBR Rectangular coffee table
Tavolo basso rettangolare
Table basse rectangulaire
Rechteckiger Couchtisch

FINISHES / FINITURE / FINITIONS / AUSFÜHRUNGEN

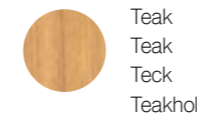

Teak
Teak
Teck
Teakholz



Removable cushions Masterline Colour Collection p. 302
Cuscini sfoderabili Masterline Colour Collection pg. 302
Coussins déhoussables Masterline Colour Collection pg. 302
Abziehbare Polster Masterline Kollektion Seite 302

- Teak / Teak / Teck / Teakholz
- Removable cushions col. standard Nuvola C01 / Cuscini sfoderabili col. standard Nuvola C01
Coussins déhoussables coul. standard Nuvola C01 / Abziehbare Polster Standardfarbe Nuvola C01

Synthesis

SITTING / SEDUTE / ASSISES / SITZMÖBEL

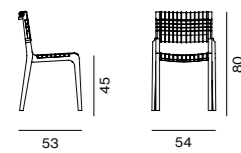

SESY Chair / Sedia / Chaise / Stuhl
SYSECU Cushion / Cuscino / Coussin
 Kissen

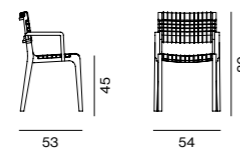

POSY Small armchair / Poltroncina
 Petit fauteuil / Armstuhll
SYSECU Cushion / Cuscino / Coussin
 Kissen

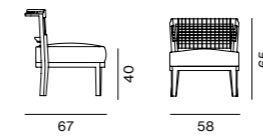

SYPB Small armchair
 Poltroncina bassa
 Petit fauteuil bas
 Niedriger Sessel
SYCUPB Cushion / Cuscino / Coussin
 Kissen

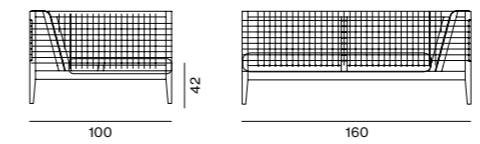

SYANS L corner module / Modulo angolo sx
 Module d'angle g / Eckmodul links
SYCUAN Cushion / Cuscino / Coussin / Sitzpolster

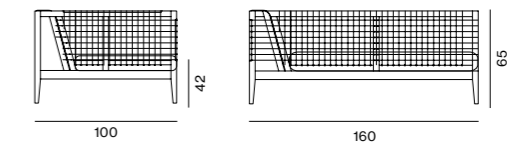

SYAND R corner module / Modulo angolo dx
 Module d'angle d / Eckmodul rechts
SYCUAN Cushion / Cuscino / Coussin / Sitzpolster

LOUNGE / LOUNGE / LOUNGE / LOUNGE

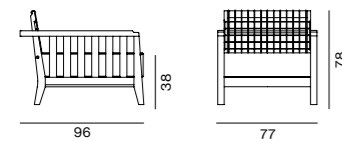

SYPO Armchair / Poltrona
 Fauteuil / Sessel
SYCUSE Cushion / Cuscino / Coussin
 Sitzpolster

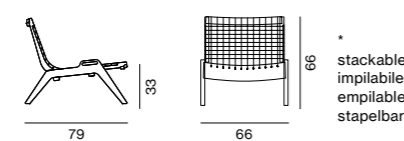

POLOS Lounge armchair
 Poltrona lounge
 Fauteuil lounge
 Loungesessel
SYPOCU Cushion / Cuscino / Coussin
 Sitzpolster

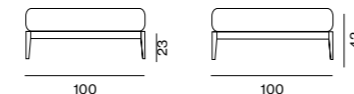

SYPU Pouf / Pouf / Pouf / Hocker
SYCUPU Cushion / Cuscino
 Coussin / Sitzpolster

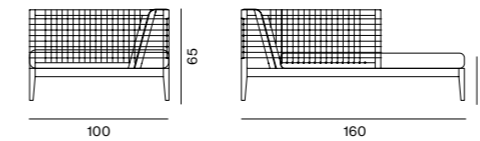

SYCHS L chaise-longue module / Modulo chaise-longue sx
 Module chaise longue g / Chaiselongue Modul links
SYCUCLS Cushion / Cuscino / Coussin / Sitzpolster

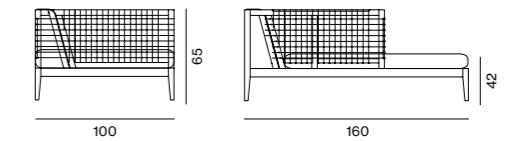

SYCHD R chaise-longue modulee / Modulo chaise-longue dx
 Module chaise longue d / Chaiselongue Modul rechts
SYCUCLD Cushion / Cuscino / Coussin / Sitzpolster

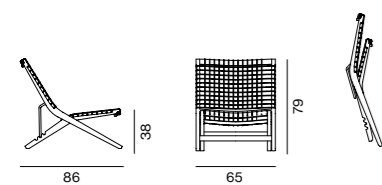

SDRASY Deckchair folding / Sdraio pieghevole
 Transat pliant / Klappbarer Liegestuhl
SYSDCU Cushion / Cuscino / Coussin / Kissen

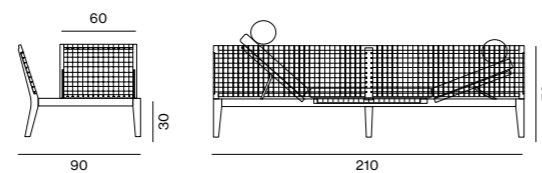

SYLD Sofa-bed adjustable seat on both sides
 Divano-lettino con seduta regolabile su entrambi i lati
 Canapé lit réglable des 2 côtés / Bettsofa mit beidseitig
 verstellbaren Sitzflächen
SYCULD Cushion / Cuscino / Coussin / Sitzpolster

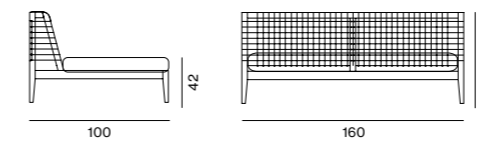

SYSP Backrest module / Modulo spalla
 Module dossier / Rückenlehnmodul
SYCUSP Cushion / Cuscino / Coussin / Sitzpolster

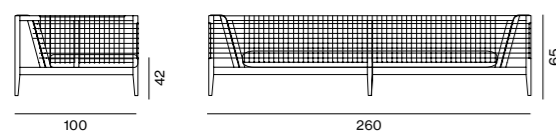

SYDIG Sofa / Divano / Canapé / Sofa
SYCUDIG Cushion / Cuscino
 Coussin / Sitzpolster

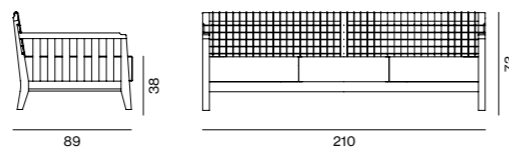

SYDI Sofa / Divano / Canapé / Sofa
SYCUSE Cushion / Cuscino
 Coussin / Sitzpolster

→ Teak / Teak / Teck / Teakholz
 → Synthetic fibre WaProLace® / Fibra sintetica WaProLace® / Fibre synthétique WaProLace® / WaProLace® Synthetikfaser
 → Removable cushions col. standard Nuvola C01 / Cuscini sfoderabili col. standard Nuvola C01 / Coussins déhoussables coul. standard Nuvola C01
 Abziehbare Kissen Standardfarbe Nuvola C01

→ Teak / Teak / Teck / Teakholz
 → Synthetic fibre WaProLace® / Fibra sintetica WaProLace® / Fibre synthétique WaProLace® / WaProLace® Synthetikfaser
 → Removable cushions col. standard Nuvola C01 / Cuscini sfoderabili col. standard Nuvola C01 / Coussins déhoussables coul. standard Nuvola C01
 Abziehbare Kissen Standardfarbe Nuvola C01

Synthesis

TABLES / TAVOLI / TABLES / TISCHE

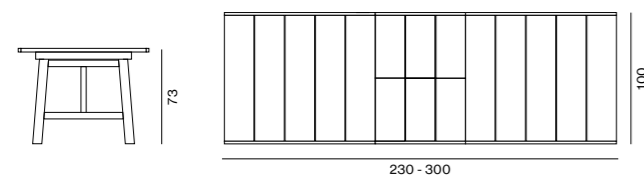

TATSY Rectangular table extendable / Tavolo allungabile rettangolare
Table allongeable rectangulaire / Rechteckiger Ausziehtisch

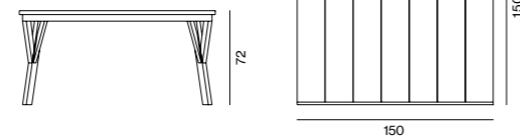

TASYQU Square table / Tavolo quadrato
Table carrée / Quadratischer Tisch

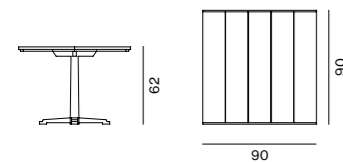

TASYQB Square table / Tavolo quadrato
Table carrée / Quadratischer Tisch

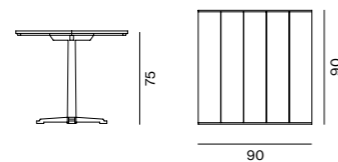

TAQULESY Square table / Tavolo quadrato
Table carrée / Quadratischer Tisch

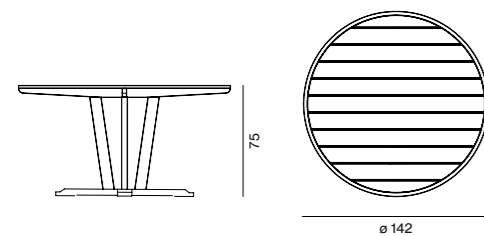

SYTARO Round table / Tavolo rotondo
Table ronde / Runder Tisch

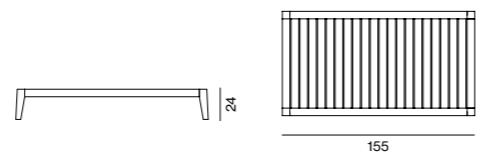

SYTABR Rectangular coffee table / Tavolo basso rettangolare
Table basse rectangulaire / Rechteckiger Couchtisch

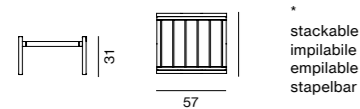

SYTABQM Square coffee table with handles
Tavolo basso quadrato con maniglie
Table basse carrée avec poignées
Quadratischer Couchtisch mit Griffen

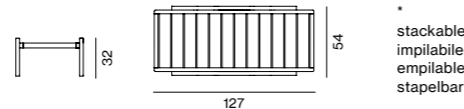

SYTABRM Rectangular coffee table with handles
Tavolo basso rettangolare con maniglie
Table basse rectangulaire avec poignées
Rechteckiger Couchtisch mit Griffen

- Teak / Teak / Teck / Teakholz
- Synthetic fibre WaProLace® / Fibra sintetica WaProLace® / Fibre synthétique WaProLace® / WaProLace® Synthetikfaser
- Removable cushions col. standard Nuvola C01 / Cuscini sfoderabili col. standard Nuvola C01 / Coussins déhoussables coul. standard Nuvola C01
Abziehbare Kissen Standardfarbe Nuvola C01

SUNLOUNGERS / LETTINI / BAINS DE SOLEIL / SONNENLIEGEN

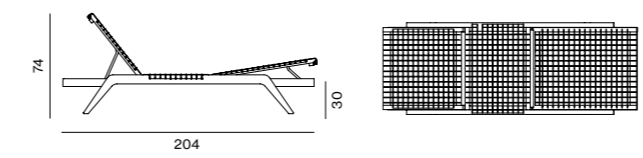

LESY Sunlounger / Lettino / Bain de soleil / Sonnenliege
SYLICU Cushion / Cuscino / Coussin / Polsterauflage

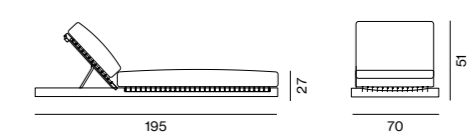

SYLEB Sunlounger low / Lettino basso
Bain de soleil bas / Niedrige Sonnenliege
SYCULEB Cushion / Cuscino / Coussin / Polsterauflage

ALCOVE / ALCOVA / ALCÔVE / ALKOVEN

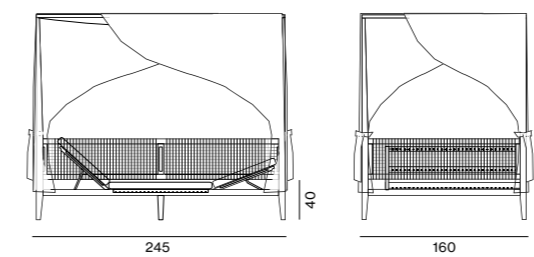

ALSYBI Alcove with adjustable seat base on both sides
Alcova con seduta regolabile su entrambi i lati
Alcôve avec base réglable des deux côtés
Alkoven mit beidseitig verstellbaren Sitzflächen

FINISHES / FINITURE / FINITIONS / AUSFÜHRUNGEN

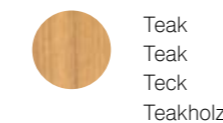

Teak
Teak
Teck
Teakholz



Removable cushions Masterline Colour Collection p. 302
Cuscini sfoderabili Masterline Colour Collection pg. 302
Coussins déhoussables Masterline Colour Collection pg. 302
Abziehbare Polster aus der Masterline Kollektion Seite 302



WaProLace® natural
WaProLace® naturale
WaProLace® naturel
WaProLace® Synthetikfaser

- Teak / Teak / Teck / Teakholz
- Synthetic fibre WaProLace® / Fibra sintetica WaProLace® / Fibre synthétique WaProLace® / WaProLace® Synthetikfaser
- Removable cushions col. standard Nuvola C01 / Cuscini sfoderabili col. standard Nuvola C01 / Coussins déhoussables coul. standard Nuvola C01
Abziehbare Polster Standardfarbe Nuvola C01

Swing

CHAISE LONGUE / CHAISE-LONGUE / CHAISE-LONGUE / CHAISLONGUE

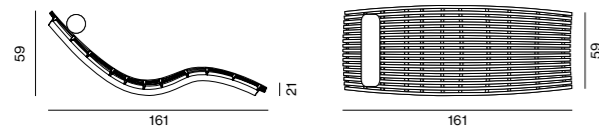

SWIDO Chaise longue / Chaise-longue
Chaise-longue / Chaiselongue
CUSWIDO001 Headrest cushion / Cuscino poggiatesta
Coussin d'appui-tête / Nackenrolle

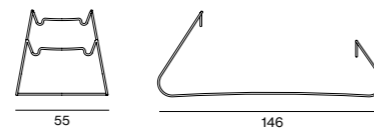

SWISUP Chaise longue Support / Supporto chaise longue
Support pour chaise longue / Halterung

STOOL / SGABELLO / TABOURET / HOCKER

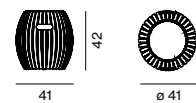

SGANTE Stool / Sgabello / Tabouret / Hocker

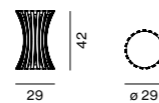

SGASWI Stool / Sgabello / Tabouret / Hocker

FINISHES / FINITURE / FINITIONS / AUSFÜHRUNGEN

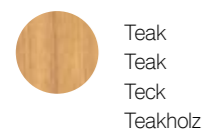

Teak
Teak
Teck
Teakholz



Stainless steel
Acciaio inox
Acier inoxydable
Edelstahl



Removable cushions Nuvola C01
Cuscini sfoderabili Nuvola C01
Coussins déhoussables Nuvola C01
Abziehbare Nackenrolle Farbe Nuvola C01

- Teak / Teak / Teck / Teakholz
- Stainless steel / Acciaio inox / Acier inoxydable / Edelstahl
- Removable cushions / Cuscini sfoderabili / Coussins déhoussables / Abziehbare Nackenrolle

Titanic

CHAISE LONGUE / CHAISE-LONGUE / CHAISE-LONGUE / CHAISLONGUE

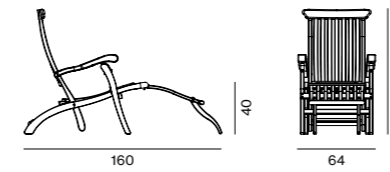

GRTIT Chaise longue / Chaise-longue / Chaise-longue / Chaiselongue
CUGT Cushion / Cuscino / Coussin / Polsterauflage

FINISHES / FINITURE / FINITIONS / AUSFÜHRUNGEN



Teak
Teak
Teck
Teakholz



Removable cushions Masterline Colour Collection p. 302
Cuscini sfoderabili Masterline Colour Collection pg. 302
Coussins déhoussables Masterline Colour Collection pg. 302
Abziehbare Polsterauflage aus der Masterline Kollektion Seite 302

- Teak / Teak / Teck / Teakholz
- Cushion col. standard Latte 04 / Cuscino col. standard Latte 04 / Coussin coul. standard Latte 04 / Abziehbare Polsterauflage in Standardfarbe 04 Latte

Toscana

SITTING / SEDUTE / ASSISES / SITZGELEGENHEITEN

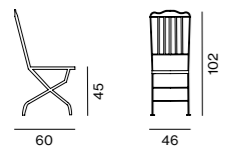

CASEG Chair / Sedia / Chaise / Stuhl
CUCAPSA Cushion / Cuscino / Coussin / Kissen

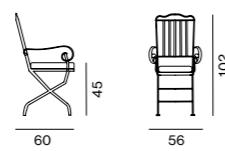

CAPOG Small armchair / Poltroncina
Petit fauteuil / Armstuhl
CUCAPSA Cushion / Cuscino / Coussin / Kissen



TORE76 Rectangular coffee table
Tavolo basso rettangolare
Table basse rectangulaire
Rechteckiger Couchtisch

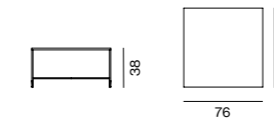

TOQU76 Square coffee table
Tavolo basso quadrato
Table basse carrée
Quadratischer Couchtisch

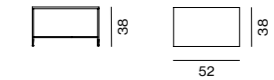

TORE38 Rectangular coffee table
Tavolo basso rettangolare
Table basse rectangulaire
Rechteckiger Couchtisch

LOUNGE / LOUNGE / LOUNGE / LOUNGE

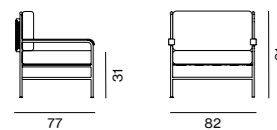

TOPO Armchair / Poltrona / Fauteuil / Sessel
TOPOCU Cushion / Cuscino / Coussin / Polster

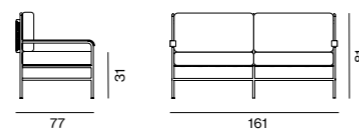

TODI Sofa / Divano / Canapé / Sofa
TODICU Cushion / Cuscino / Coussin / Polster

TABLES / TAVOLI / TABLES / TISCHE

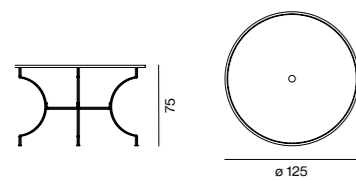

PAROG Round table / Tavolo rotondo
Table ronde / Runder Tisch

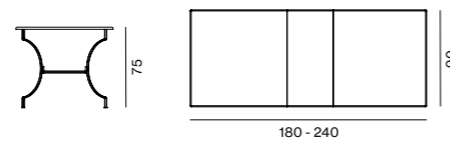

ARTAV Rectangular extendable table / Tavolo allungabile rettangolare
Table extensible rectangulaire / Rechteckiger Ausziehtisch

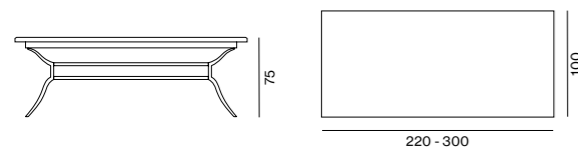

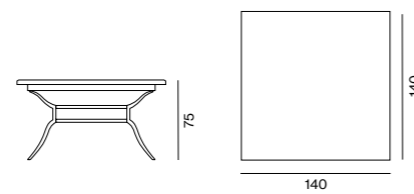

AVTAV Rectangular extendable table / Tavolo allungabile rettangolare
Table extensible rectangulaire / Rechteckiger Ausziehtisch



AVTAVQ Square table / Tavolo quadrato
Table carrée / Quadratischer Tisch

FINISHES / FINITURE / FINITIONS / AUSFÜHRUNGEN

 Powder coated galvanized iron graphite
Ferro zincato verniciato a polveri grafite
Fer galvanisé enduit de poudre graphite
Verzinktes, pulverbeschichtetes Eisen grafitgrau

 Removable cushions Masterline Colour Collection p. 302
Cuscini sfoderabili Masterline Colour Collection pg. 302
Coussins déhoussables Masterline Colour Collection pg. 302
Abziehbare Polster aus der Masterline Kollektion Seite 302

→ Powder coated galvanized iron / Ferro zincato verniciato a polveri / Fer galvanisé enduit de poudre / Verzinktes, pulverbeschichtetes Eisen
→ Removable cushions col. standard Latte 04 / Cuscini sfoderabili col. standard Latte 04 / Coussins déhoussables coul. standard Latte 04
Abziehbare Polster in Standardfarbe 04 Latte

→ Powder coated galvanized iron / Ferro zincato verniciato a polveri / Fer galvanisé enduit de poudre / Verzinktes, pulverbeschichtetes Eisen
→ Removable cushions col. standard Latte 04 / Cuscini sfoderabili col. standard Latte 04 / Coussins déhoussables coul. standard Latte 04
Abziehbare Polster in Standardfarbe 04 Latte

Treble

SITTING AND LOUNGE / SEDUTA E LOUNGE / LOUNGEMÖBEL

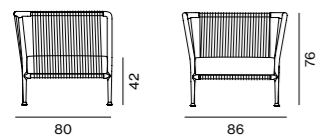

Armchair / Poltrona / Fauteuil / Sessel

TREPOA	Sand - white melange / Sabbia - bianco melange Sable - blanc mélangé / Sand - weiß meliert
TREPOGR	Graphite - white melange / Grafite - bianco melange Graphite - blanc mélangé / Grafitgrau - weiß meliert
TREPOS	Syrah - marsala
TREPOVS	Sage - green melange / Salvia - verde melange Sauge - vert mélangé / Salbeigrün - grün meliert

TRECUPO	Cushion / Cuscino / Coussin / Sitzpolster
TRECUSC	Cushion backrest / Cuscino schienale Coussin dossier / Rückenpolster

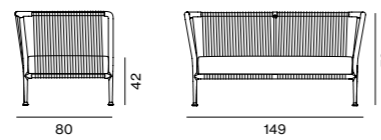

Sofa / Divano / Canapé / Sofa

TREDIA	Sand - white melange / Sabbia - bianco melange Sable - blanc mélangé / Sand - weiß meliert
TREDIGR	Graphite - white melange / Grafite - bianco melange Graphite - blanc mélangé / Grafitgrau - weiß meliert
TREDIS	Syrah - marsala
TREDIVS	Sage - green melange / Salvia - verde melange Sauge - vert mélangé / Salbeigrün - grün meliert

TRECUSE	Cushion / Cuscino / Coussin / Sitzpolster
TRECUSC	Cushion backrest / Cuscino schienale Coussin dossier / Rückenpolster

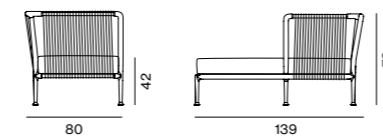

L chaise-longue module / Modulo chaise-longue sx
Module chaise longue g / Chaiselongue Modul links

TRELOSA	Sand - white melange / Sabbia - bianco melange Sable - blanc mélangé / Sand - weiß meliert
TRELOSGR	Graphite - white melange / Grafite - bianco melange Graphite - blanc mélangé / Grafitgrau - weiß meliert
TRELOSS	Syrah - marsala
TRELOSVS	Sage - green melange / Salvia - verde melange Sauge - vert mélangé / Salbeigrün - grün meliert

TRECUSE	Cushion / Cuscino / Coussin / Sitzpolster
TRECUSC	Cushion backrest / Cuscino schienale Coussin dossier / Rückenpolster

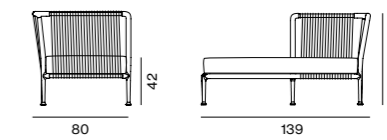

R chaise-longue module / Modulo chaise-longue dx
Module chaise longue d / Chaiselongue Modul rechts

TRELODA	Sand - white melange / Sabbia - bianco melange Sable - blanc mélangé / Sand - weiß meliert
TRELODGR	Graphite - white melange / Grafite - bianco melange Graphite - blanc mélangé / Grafitgrau - weiß meliert
TRELODS	Syrah - marsala
TRELODVS	Sage - green melange / Salvia - verde melange Sauge - vert mélangé / Salbeigrün - grün meliert

TRECUSE	Cushion / Cuscino / Coussin / Sitzpolster
TRECUSC	Cushion backrest / Cuscino schienale Coussin dossier / Rückenpolster

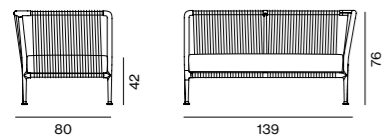

L corner module / Modulo angolo sx / Module d'angle g / Eckmodul links

TREANSA	Sand - white melange / Sabbia - bianco melange Sable - blanc mélangé / Sand - weiß meliert
TREANSGR	Graphite - white melange / Grafite - bianco melange Graphite - blanc mélangé / Grafitgrau - weiß meliert
TREANSS	Syrah - marsala
TREANSVS	Sage - green melange / Salvia - verde melange Sauge - vert mélangé / Salbeigrün - grün meliert

TRECUSE	Cushion / Cuscino / Coussin / Sitzpolster
TRECUSC	Cushion backrest / Cuscino schienale Coussin dossier / Rückenpolster

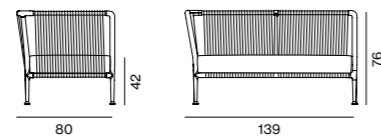

R corner module / Modulo angolo dx / Module d'angle d / Eckmodul rechts

TREANDA	Sand - white melange / Sabbia - bianco melange Sable - blanc mélangé / Sand - weiß meliert
TREANDGR	Graphite - white melange / Grafite - bianco melange Graphite - blanc mélangé / Grafitgrau - weiß meliert
TREANDS	Syrah - marsala
TREANDVS	Sage - green melange / Salvia - verde melange Sauge - vert mélangé / Salbeigrün - grün meliert

TRECUSE	Cushion / Cuscino / Coussin / Sitzpolster
TRECUSC	Cushion backrest / Cuscino schienale Coussin dossier / Rückenpolster

TABLES / TAVOLI / TABLES / TISCHE

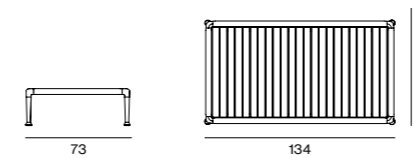

Rectangular coffee table with top in teak / Tavolo basso rettangolare con piano in teak
Table basse rectangulaire avec plateau en teck / Rechteckiger Couchtisch mit Teakholzplatte

TRETABA	Sand / Sabbia / Sable / Sandfarben
TRETAGR	Graphite / Grafite / Graphite / Grafitgrau
TRETABS	Syrah
TRETABVS	Green sage / Salvia / Vert sauge / Salbeigrün

FINISHES / FINITURE / FINITIONS / AUSFÜHRUNGEN



Aluminum graphite
Alluminio grafite
Aluminium graphite
Aluminium grafitgrau



Aluminum syrah
Alluminio syrah
Aluminium syrah
Aluminium syrah



Aluminium sand
Alluminio sabbia
Aluminium sable
Aluminium sandfarben

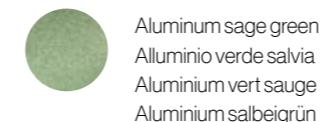

Aluminum sage green
Alluminio verde salvia
Aluminium vert sauge
Aluminium salbeigrün



Polipropylene cord white melange
Corda polipropilene bianco melange
Corde polypropylène blanc mélangé
Seil aus Polypropylen weiß meliert



Polipropylene cord green melange
Corda polipropilene verde melange
Corde polypropylène vert mélangé
Seil aus Polypropylen grün meliert



Polipropylene cord marsala
Corda polipropilene marsala
Corde polypropylène marsala
Seil aus Polypropylen marsala

→ Aluminum / Alluminio / Aluminium / Aluminium

→ Polypropylene cord / Corda polipropilene / Corde en polypropylène / Seil aus Polypropylen

Welcome

LOUNGE / LOUNGE / LOUNGE / LOUNGE

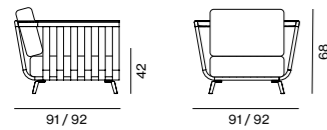

- WELPO** Armchair teak with seat and backrest cushions
Poltrona teak con cuscino di seduta e schienale
Fauteuil en teck avec coussins d'assise et dossier
Teakholzsessel mit Sitz- und Rückenpolster
- WELCPO** Armchair teak and cord with seat and backrest cushions
Poltrona teak e corda con cuscino di seduta e schienale
Fauteuil en teck et corde avec coussins d'assise et dossier
Sessel aus Teakholz und Seil mit Sitz- und Rückenpolster

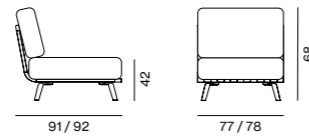

- WELSPA** Backrest module teak with seat and backrest cushions
Modulo spalla teak con cuscino di seduta e schienale
Module dossier en teck avec coussins d'assise et dossier
Rückenlehnmodul aus Teakholz mit Sitz- und Rückenpolster
- WELCSPA** Backrest module teak and cord with seat and backrest cushions
Modulo spalla teak e corda con cuscino di seduta e schienale
Module dossier en teck et corde avec coussin de assise et de dos
Rückenlehnmodul aus Teakholz und Seil mit Sitz- und Rückenpolster

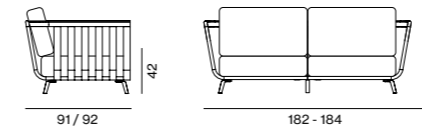

- WEDIP** Sofa teak with seat and backrest cushions
Divano teak con cuscino di seduta e schienale
Canapé en teck avec coussins d'assise et dossier
Sofa aus Teakholz mit Sitz- und Rückenpolster
- WEDIPC** Sofa teak and cord with seat and backrest cushions
Divano teak e corda con cuscino di seduta e schienale
Canapé en teck et corde avec coussins d'assise et dossier
Sofa aus Teakholz und Seil mit Sitz- und Rückenpolster

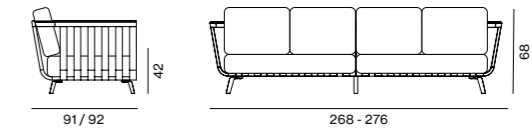

- WEDIG** Sofa teak with seat and backrest cushions
Divano teak con cuscino di seduta e schienale
Canapé en teck avec coussins d'assise et dossier
Sofa aus Teakholz mit Sitz- und Rückenpolster
- WEDIGC** Sofa teak and cord with seat and backrest cushions
Divano teak e corda con cuscino di seduta e schienale
Canapé en teck et corde avec coussins d'assise et dossier
Sofa aus Teakholz und Seil mit Sitz- und Rückenpolster

COFFEE TABLES / TAVOLINI / TABLE BASSE / COUCHTISCHE

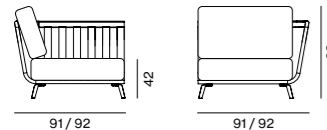

- WA90S** L module teak with seat and backrest cushions
Modulo sx teak con cuscino di seduta e schienale
Module g en teck avec coussins d'assise et dossier
Linkes Teakholzmodul mit Sitz- und Rückenpolster
- WAC90S** Lt module teak and cord with seat and backrest cushions
Modulo sx teak e corda con cuscino di seduta e schienale
Module g en teck et corde avec coussins d'assise et dossier
Linkes Modul aus Teakholz und Seil mit Sitz- und Rückenpolster

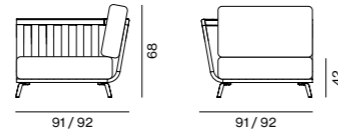

- WA90D** R module teak with seat and backrest cushions
Modulo dx teak con cuscino di seduta e schienale
Module d en teck avec coussins d'assise et dossier
Rechtes Teakholzmodul mit Sitz- und Rückenpolster
- WAC90D** Rt module teak and cord with seat and backrest cushions
Modulo dx teak e corda con cuscino di seduta e schienale
Module d en teck et corde avec coussins d'assise et dossier
Rechtes Modul aus Teakholz und Seil mit Sitz- und Rückenpolster

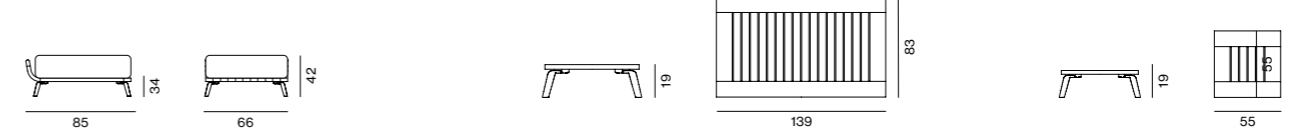

- WELPU** Pouf with seat cushion
Pouf con cuscino di seduta
Pouf avec coussin de assise
Hocker mit Sitzpolster
- WELTABR** Rectangular coffee table
Tavolo basso rettangolare
Table basse rectangulaire
Rechteckiger Couchtisch
- WELTABQ** Square coffee table
Tavolo basso quadrato
Table basse carrée
Quadratischer Couchtisch

Add a WELCU63SC cushion for an L-shaped configuration.
Per la configurazione a L aggiungere un cuscino WELCU63SC.
Pour une configuration en L, ajouter un coussin WELCU63SC.
Für eine L-förmige Konfiguration fügen Sie ein Kissen WELCU63SC hinzu.

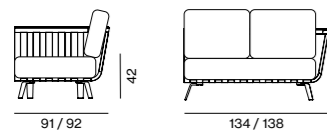

- WA130S** L module teak with seat and backrest cushions
Modulo sx teak con cuscino di seduta e schienale
Module g en teck avec coussins d'assise et dossier
Linkes Teakholzmodul mit Sitz- und Rückenpolster
- WAC130S** Lt module teak and cord with seat and backrest cushions
Modulo sx teak e corda con cuscino di seduta e schienale
Module g en teck et corde avec coussins d'assise et dossier
Linkes Modul aus Teakholz und Seil mit Sitz- und Rückenpolster

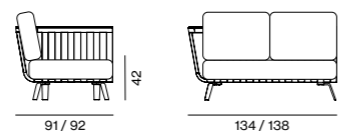

- WA130D** R module teak with seat and backrest cushions
Modulo dx teak con cuscino di seduta e schienale
Module d en teck avec coussins d'assise et dossier
Rechtes Teakholzmodul mit Sitz- und Rückenpolster
- WAC130D** Rt module teak and cord with seat and backrest cushions
Modulo dx teak e corda con cuscino di seduta e schienale
Module d en teck et corde avec coussins d'assise et dossier
Rechtes Modul aus Teakholz und Seil mit Sitz- und Rückenpolster

FINISHES / FINITURE / FINITIONS / AUSFÜHRUNGEN

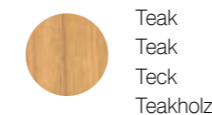

Teak
Teak
Teck
Teakholz

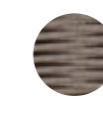

Polyolefin cord beige mélange
Corda poliolefinica beige mélange
Corde en polyoléfine beige mélangé
Polyolefin-Seil beige meliert



Aluminum bronze
Alluminio bronzo
Aluminium bronze
Aluminium bronze



Removable cushions Masterline Colour Collection p. 302
Cuscini sfoderabili Masterline Colour Collection pg. 302
Coussins déhoussables Masterline Colour Collection pg. 302
Abziehbare Polster aus der Masterline Kollektion Seite 302

- Teak / Teak / Teck / Teakholz
 - Aluminum / Alluminio / Aluminium / Aluminium
 - Polyolefin cord / Corda poliolefinica / Corde en polyoléfine / Polyolefin-Seil
 - Removable cushions col. standard Nuvola C01 / Cuscini sfoderabili col. standard Nuvola C01 / Coussins déhoussables coul. standard Nuvolas C01
- Abziehbare Polster Standardfarbe Nuvola C01

William

SITTING / SEDUTE / ASSISES / SITZMÖBEL

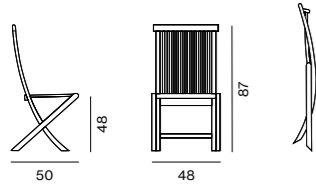

WILSED Chair William / Sedia William / Chaise William / Stuhl William
CUSEDA Cushion / Cuscino / Coussin / Kissen

FINISHES / FINITURE / FINITIONS / AUSFÜHRUNGEN



Teak
Teak
Teck
Teakholz



Cushion Masterline Colour Collection p. 302
Cuscino Masterline Colour Collection pg. 302
Coussin Masterline Colour Collection pg. 302
Abziehbares Kissen Masterline Kollektion Seite 302

→ Teak / Teak / Teck / Teakholz
→ Cushion col. standard Latte 04 / Cuscino col. standard Latte 04 / Coussin coul. standard Latte 04 / Abziehbares Kissen in Standardfarbe 04 Latte

Sunshades
Technical
Sheets

Covercar
Dafne
Damian
Levante
Lipari
Manta
Nagi
Wood Garden
Orangerie
Salento
Shibuya
Solaire
Tibisco

Covercar

COVERCAR SINGLE / COVERCAR SINGOLO / COVERCAR SINGLE / EINZELCOVERCAR



W 393 D 450 H 255

W 393 D 578 H 255

COVERCAR DOUBLE / COVERCAR DOPPIO / COVERCAR DOUBLE / DOPPELCOVERCAR



W 709 D 450 H 255

W 709 D 578 H 255

Covercar / Covercar / Covercar / Covercar	W 393 D 450 H 255	COS45G
	W 393 D 578 H 255	COS60G
Double covercar / Covercar doppio / Covercar double / Doppelcovercar	W 709 D 450 H 255	COD45G
	W 709 D 578 H 255	COD60G
Single extension to widen COD45G Estensione singola per estendere in larghezza il COD45G Extension simple pour agrandir en largeur un covercar COD45G Erweiterung, um einem COD45G zu verbreitern	W 318 D 450 H 255	COD45GEX
Single extension to widen COD60G Estensione singola per estendere in larghezza il COD60G Extension simple pour agrandir en largeur un covercar COD60G Erweiterung, um einem COD60G zu verbreitern	W 318 D 578 H 255	COD60GEX

Fixing kit excluded / Kit di fissaggio escluso / kit de fixation exclu / Ohne Befestigungsmaterial

For the white finish add the letter 'W' in front of the article code e.g. WCOS45G

Per la finitura di colore bianco aggiungere la lettera "W" davanti al codice articolo es. WCOS45G

Pour la finition en blanc ajouter la lettre "W" devant le code de l'article, par exemple WCOS45G

Für die weiße Ausführung ergänzen Sie den Buchstaben "W" am Anfang der Artikelnummer, z.B. WCOS45G

The structure is in treated Nordic pine and can be painted in dark walnut, teak or in colours from the Unopiù Colour range. The structure can be enclosed using infill components the Wood Garden range. / La struttura è in pino nordico impregnato e può essere tinteggiata nelle tonalità noce scuro, teak o nei colori della linea Unopiù Color. / La struttura può essere chiusa con gli elementi del sistema Wood Garden. / La structure est en pin nordique traité et peut être teintée dans les tonalités noyer foncé, teak ou dans les couleurs de la ligne Unopiù Color. La structure peut être fermée avec les éléments de la ligne Wood Garden. / Die Struktur ist aus imprägniertem, nordischem Kiefernholz und kann mit den Farben dunkelbraun, teakholzfarben oder den Farben der Serie Unopiù Color angestrichen werden. Dazu passend gibt es die Elemente des Systems Wood Garden.

FINISHES / FINITURE / FINITIONS / AUSFÜHRUNGEN

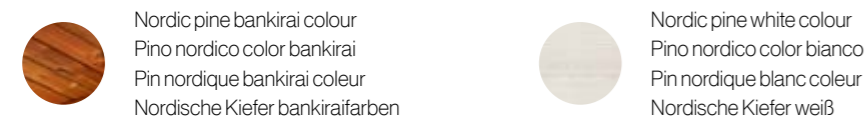

Nordic pine bankirai colour
Pino nordico color bankirai
Pin nordique bankirai couleur
Nordische Kiefer bankiraifarben

Nordic pine white colour
Pino nordico color bianco
Pin nordique blanc couleur
Nordische Kiefer weiß

→ Nordic pine / Pino nordico / Pin nordique / Nordische Kiefer

Dafne

AWNING / PENSILINA / AUVENT / VORDACH

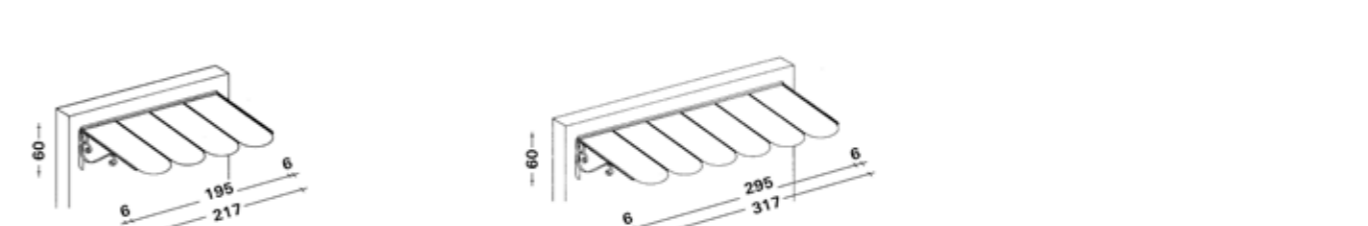

W 217 D 120 H 60

W 317 D 120 H 60

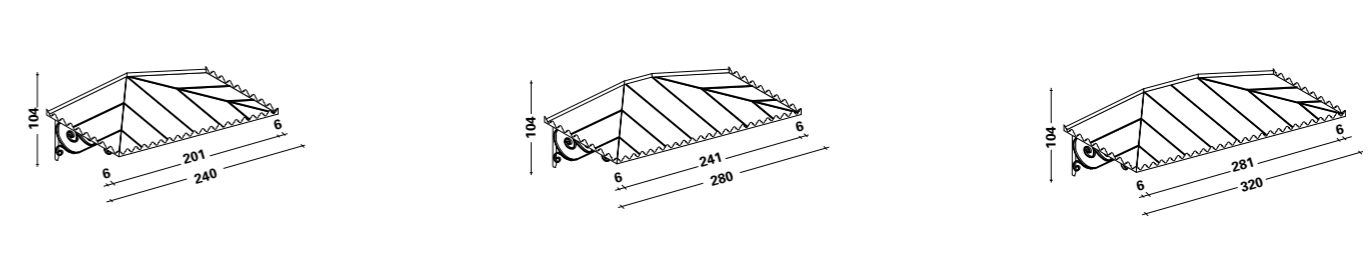

W 240 D 120 H 104

W 280 D 120 H 104

W 320 D 120 H 104

Awning / Pensilina / Auvent / Vordach	W 217 D 120 H 60	PEF200
	W 317 D 120 H 60	PEF300
Extension for PEF200 - PEF300 / Estensione per PEF200 - PEF300 Extension pour PEF200 - PEF300 / Erweiterung für PEF200 - PEF300	W 201 D 120 H 60	PEF200EX
	W 301 D 120 H 60	PEF300EX
Awning / Pensilina / Auvent / Vordach	W 240 D 120 H 104	PES240
	W 280 D 120 H 104	PES280
	W 320 D 120 H 104	PES320

Fixing kit excluded / Kit di fissaggio escluso / kit de excluded / Ohne Befestigungsmaterial

FINISHES / FINITURE / FINITIONS / AUSFÜHRUNGEN



Iron graphite
Ferro color grafite
Fer couleur graphite
Eisen in Grafitgrau

Polycarbonate embossed
Policarbonato goffrato
Polycarbonate gaufré
Polycarbonat geprägt

→ Powder coated galvanized iron / Ferro zincato verniciato a polveri / Fer galvanisé enduit de poudre / Verzinktes, pulverbeschichtetes Eisen grafitgrau

→ Polycarbonate embossed / Policarbonato goffrato / Polycarbonate gaufré / Polycarbonat geprägt

Damian

UMBRELLAS / OMBRELLONI / PARASOLS / SONNENSCHIRME

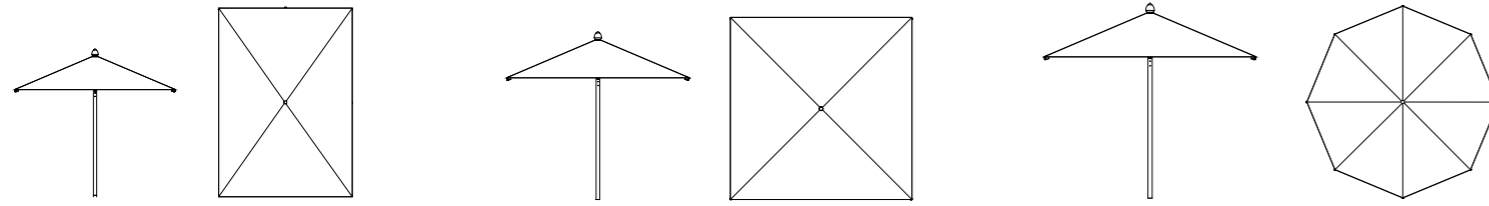

Ø 6 / 250 x 350 H 277

Ø 6 / 300 x 300 H 277

Ø 6 / Ø 350 H 277

Wood shafts Ø 6 / palo in legno Ø 6 / mât en bois Ø 6 / Holzmast Ø 6	250 x 350 H 277	300 x 300 H 277	Ø 350 H 277
Off white with blue border / Bianco grezzo bordino blu Blanc écru avec bordure bleue / Naturfarben mit blauem Rand	RE95BLU	QU98BLU	RO92BLU
Cord with brown border/ Corda bordino marrone Corde avec bordure marron / Sandfarben mit braunem Rand	RE95MAR	QU98MAR	RO92MAR

FINISHES / FINITURE / FINITIONS / AUSFÜHRUNGEN

100% acrylic off white
100% acrilico bianco grezzo
100% acrylique blanc écru
100% Baumwolle naturbelassen

100% acrylic cord
100% acrilico corda
100% acrylique corde
100% Acryl sandfarben

Solid wood
Legno massello
Bois massif
Massivholz

→ Solid wood / Legno massello / Bois massif / Massivholz
→ Acrylic 100% / Acrilico 100% / 100% Acrylique / 100% Acryl

Levante

UMBRELLAS / OMBRELLONI / PARASOLS / SONNENSCHIRME

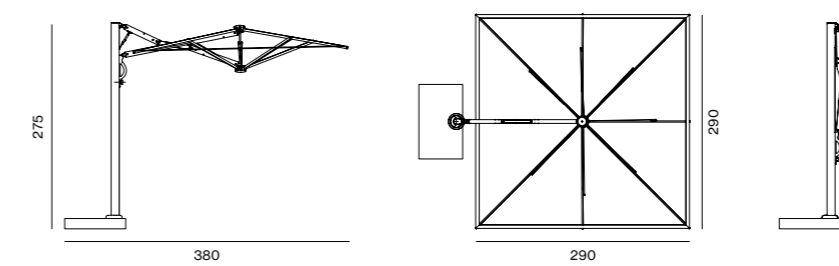

W 290 D 290 H 275/295

Aluminium parasol with titanium effect finish, graphite powder-coated galvanised steel base, motion opening, with fabric cover and 100% acrylic piping, Teflon resin-coated, water-repellent, water column approx. 25 cm - weight 350 g/m², mould- and bacteria-proof. Ombrellone in alluminio con finitura effetto titanium, base di acciaio zincato verniciato a polveri colore grafite, apertura motion, con telo in tessuto e piping 100% acrilico resinatura teflon, idro-oleorepellenza, colonna d'acqua circa 25 cm - grammatura 350 gr/m², inattaccabile da muffe e batteri

Parasol en aluminium avec finition effet titane, base en acier galvanisé revêtu de poudre graphite, ouverture à mouvement, avec housse en tissu et passepoil 100% acrylique, revêtu de résine téflon, hydrofuge, colonne d'eau d'environ 25 cm - poids 350 g/m², résistant aux moisissures et aux bactéries.

Sonnenschirm aus Aluminium mit Titanium-Finish Effekt, galvanisiertes Stahlgestell mit Pulverbeschichtung in der Farbe grafitgrau, Motion-Öffnung, mit Stoffbezug und Einfassung aus 100% Acryl, teflonbeschichtet, wasserabweisend, Wassersäule ungefähr 25 cm - Gewicht 350g/m², Schimmel- und Bakterien-Resistent.

Parasol with high-brightness kit. Aluminium parasol with titanium effect finish, graphite powder-coated galvanised steel base, motion opening, with fabric cover and 100% acrylic piping, Teflon resin-coated, water-oilrepellency, water column approx. 25 cm - weight 350 g/m², mould- and bacteria-proof. Rechargeable battery with 8 h autonomy. Dimmable 3000k LED light with remote control. Complete wiring.

Ombrellone con kit alta luminosità. Ombrellone in alluminio con finitura effetto titanium, base di acciaio zincato verniciato a polveri colore grafite, apertura motion, con telo in tessuto e piping 100% acrilico resinatura teflon, idro-oleorepellenza, colonna d'acqua circa 25 cm - grammatura 350 gr/m², inattaccabile da muffe e batteria ricaricabile con autonomia 8 h. Luce led 3000k dimmerabile con telecomando remote control. Cablaggio completo.

Parasol en aluminium avec finition effet titane, base en acier galvanisé revêtu de poudre graphite, ouverture à mouvement, avec housse en tissu et passepoil 100% acrylique, revêtu de résine téflon, hydrofuge, colonne d'eau d'environ 25 cm - poids 350 g/m², résistant aux moisissures et aux bactéries. Batterie rechargeable avec une autonomie de 8 h. Lampe LED 3000k à variateur avec télécommande. Câblage complet.

Sonnenschirm mit Beleuchtungsset. Sonnenschirm aus Aluminium mit Titanium-Finish Effekt, galvanisiertes Stahlgestell mit Pulverbeschichtung in der Farbe grafitgrau, Motion-Öffnung, mit Stoffbezug und Einfassung aus 100% Acryl, teflonbeschichtet, wasser- und ölabweisend, Wassersäule ungefähr 25 cm - Gewicht 350 g/m², Schimmel- und Bakterien-Resistent. Wiederaufladbare Batterie mit 8 h Laufzeit. Dimmbares LED Licht mit 3000K mit Fernbedienung. Komplett verkabelt.

ACCESSORIES / ACCESSORI / ACCESSOIRES / ZUBEHÖR

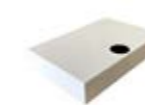

Base cover in galvanised, titanium-coloured powder-coated steel.
Carter di copertura della base in acciaio zincato e verniciato a polveri color titanio
Couvercle de la base en acier galvanisé, revêtu de poudre couleur titane.
Abdeckung für Gestell aus galvanisiertem Stahl, pulverbeschichtet in der Farbe titanium.

OMBLECARG

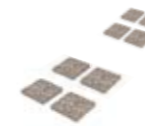

Set of 10 50 x 50 shot-blasted concrete tiles.
Set di 10 mattonelle 50 x 50 di cemento granigliato
Lot de 10 carreaux en béton grenailé de 50 x 50.
Set mit 10 Betonsplittplatten 50x50 cm

BAOMLEV

FINISHES / FINITURE / FINITIONS / AUSFÜHRUNGEN

Aluminium titanium finishing
Alluminio finitura titanio
Aluminium finition titane
Aluminium mit Titanium-Finish

Galvanized steel graphite
Acciaio zincato color grafite
Acier galvanisé couleur graphite
Verzinktes Stahl grafitgrau

100% acrylic ecru
100% acrilico ecru
100% acrylique écru
100% Acryl ecru

100% acrylic blue navy
100% acrilico blu navy
100% acrylique bleu marine
100% Acryl marineblau

Black piping
Piping nero
Passepoil noir
schwarze Einfassung

→ Aluminium titanium finishing / Alluminio finitura titanio / Aluminium finition titane / Aluminium mit Titanium-Finish
→ Galvanized steel graphite / Acciaio zincato color grafite / Acier galvanisé couleur graphite / Verzinktes Stahl grafitgrau
→ Acrylic 100% / Acrilico 100% / 100% Acrylique / 100% Acryl

Lipari

RECTANGULAR UMBRELLAS / OMBRELLONI RETTANGOLARI / PARASOLS RECTANGULAIRES / RECHTECKIGE SCHIRME

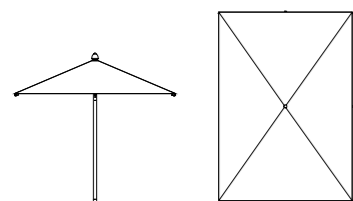

Ø 6 / 250 x 350 H 277 - 300 x 400 H 295

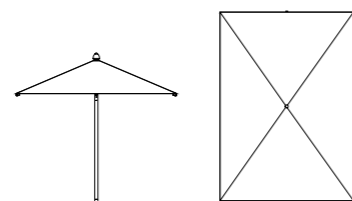

Ø 4 / 300 x 200 H 264

Wood shafts Ø 6 / palo in legno Ø 6 / mât en bois Ø 6 / Holzmast Ø 6	250 x 350 H 277	300 x 400 H 295
Off white / Bianco grezzo / Blanc écru / Naturfarben	RE95A	RE34A
Coffee / Caffé / Café / Kaffeefarben	RE95MA	RE34MA
Cord / Corda / Corde / Sandfarben	RE95CA	RE34CA
Rust / Ruggine / Rouille / Rostrot	RE95RUA	RE34RUA
Dove grey / Tortora / Tourterelle / Taubengrau	RE95TOA	RE34TOA
Aluminium shafts Ø 4 / Palo in alluminio Ø 4 / Mât en aluminium Ø 4 / Aluminiummast Ø 4		300 x 200 - H 264
(*) Off white / Bianco grezzo / Blanc écru / Naturfarben		OMSUREB
(*) Cord / Corda / Corde / Sandfarben		OMSUREC

(*) Polyester 100% / Poliestere 100% / Polyester 100% / 100% Polyester

SQUARE UMBRELLAS / OMBRELLONI QUADRATI / PARASOLS CARRÉS / QUADRATISCHE SCHIRME

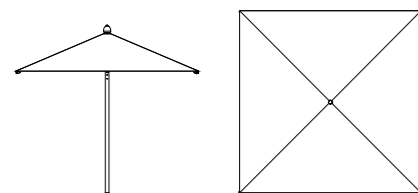

Ø 6 / 300 x 300 H 277 - 400 x 400 H 322

Wood shafts Ø 6 / Palo in legno Ø 6 / Mât en bois Ø 6 / Holzmast Ø 6	300 x 300 H 277	400 x 400 H 322
Off white / Bianco grezzo / Blanc écru / Naturfarben	QU98A	QU4A
Coffee / Caffé / Café / Kaffeefarben	QU98MA	QU4MA
Cord / Corda / Corde / Sandfarben	QU98CA	QU4CA
Rust / Ruggine / Rouille / Rostrot	QU98RUA	QU4RUA
Dove grey / Tortora / Tourterell / Taubengrau	QU98TOA	QU4TOA

- Solid wood / Legno massello / Bois massif / Massivholz
- Aluminum / Alluminio / Aluminium / Aluminium
- Cement / Cemento / Béton / Beton
- Acrylic 100% / Acrilico 100% / 100% Acrylique / 100% Acryl
- Polyester 100% / Poliestere 100% / Polyester 100% / 100% Polyester

ROUND UMBRELLAS / OMBRELLONI ROTONDI / PARASOLS RONDS / RUNDE SCHIRME

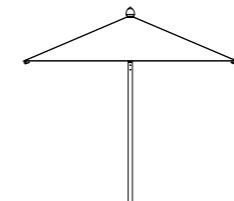

Ø 6 / Ø 350 H 277 - Ø 400 H 295

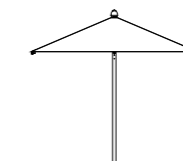
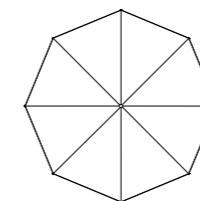

Ø 4 / Ø 280 H 254

Wood shafts Ø 6 / Palo in legno Ø 6 / Mât en bois Ø 6 / Holzmast Ø 6	Ø 350 H 277	Ø 400 H 295
Off white / Bianco grezzo / Blanc écru / Naturfarben	RO92A	RO4A
Coffee / Caffé / Café / Kaffeefarben	RO92MA	RO4MA
Cord / Corda / Corde / Sandfarben	RO92CA	RO4CA
Rust / Ruggine / Rouille / Rostrot	RO92RUA	RO4RUA
Dove grey / Tortora / Tourterelle / Taubengrau	RO92TOA	RO4TOA
Aluminium shafts Ø 4 / Palo in alluminio Ø 4 / Mât en aluminium Ø 4 / Aluminiummast Ø 4		Ø 280 H 254
(*) Off white / Bianco grezzo / Blanc écru / Naturfarben		OMSUROB
(*) Cord / Corda / Corde / Sandfarben		OMSUROC

(*) Polyester 100% / Poliestere 100% / Polyester 100% / 100% Polyester

CONCRETE BASE / BASE IN CEMENTO / BASE EN BÉTON / BETONSTÄNDER



Concrete base with adjustable wood top with hole for umbrella (pole Ø 4)
 Base in cemento con piano regolabile in legno con foro per ombrellone (palo Ø 4)
 Base en béton et plateau réglable en bois avec trou pour parasol (mât Ø 4)
 Betonständer mit höhenverstellbarer Tischplatte aus Irokoholz, für Schirme (Mast Ø 4)

base Ø 45 top Ø 55 H 53 max.
 base Ø 45 piano Ø 55 H 53 max.
 base Ø 45 plateau Ø 55 H 53 max
 Unterteil Ø 45 Platte Ø 55 H 53 max

BAOMCEP











Concrete base with adjustable wood top with hole for umbrella (pole Ø 5 - 6)
 Base in cemento con piano regolabile in legno con foro per ombrellone (palo Ø 5 - 6)
 Base en béton et plateau réglable en bois avec trou pour parasol (mât Ø 5 - 6)
 Betonständer mit höhenverstellbarer Tischplatte aus Irokoholz, für Schirme (Mast Ø 5 - 6)

base Ø 70 top Ø 85 H 74 max.
 base Ø 70 piano Ø 85 H 74 max.
 base Ø 70 plateau Ø 85 H 74 max.
 Unterteil Ø 70 Platte Ø 85 H 74 max.

BAOMCEG

- Solid wood / Legno massello / Bois massif / Massivholz
- Aluminum / Alluminio / Aluminium / Aluminium
- Cement / Cemento / Béton / Beton
- Acrylic 100% / Acrilico 100% / 100% Acrylique / 100% Acryl
- Polyester 100% / Poliestere 100% / Polyester 100% / 100% Polyester

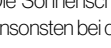
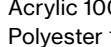
ACCESSORIES / ACCESSORI / ACCESSOIRES / ZUBEHÖR

	Base plate 62 x 62 in powder coated galvanized iron for umbrellas Piastra di base 62 x 62 ferro zincato verniciato a polveri per ombrelloni Socle 62 x 62 en fer galvanisé enduit de poudre pour parasol Schirmständer 62x62 cm aus galvanisiertem Eisen, pulverbeschichtet für Sonnenschirme	White / Bianco / Blanc / Weiß PI62B
	Single umbrella sleeve Canotto singolo per ombrellone Adaptateur simple pour parasol Bodenhülse für einen Schirm	White / Bianco / Blanc / Weiß PI62BCAN
	Ballast for umbrella base (15 kg) Zavorra per base ombrellone (Kg. 15) Contrepoids pour base parasol (Kg. 15) Ballast für Schirmständer (15 kg)	White / Bianco / Blanc / Weiß PI62BZAV
	Kit of four feet in black for umbrella base Kit 4 piedini colore nero per base ombrellone Kit de 4 petits pieds couleur noir pour base parasol Set mit 4 schwarzen Füßen für Schirmständer	Graphite / Grafite Graphite / Grafitgrau PI62GCAN
	Base plate Serena 40 x 40 35 kg with sleeve (to accommodate shafts max Ø 4) in galvanized iron - for OMSUREB / OMSUREC Base di pietra Serena 40 x 40 kg 35 con cannotto (predisposto per accogliere steli Ø max. 4) di ferro zincato - per OMSUREB / OMSUREC Socle en pierre Serena 40 x 40 kg 35 avec bague (prévue pour accueillir des mâts Ø max. 4) en fer galvanisé - pour OMSUREB / OMSUREC Schirmständer aus Serena-Stein 40x40 cm (35 kg) mit Metallrohr für Masten mit max. Ø 4 (OMSUREB / OMSUREC)	White / Bianco / Blanc / Weiß PI62GZAV
	Light W 72 cm for outdoor use (suitable for umbrella shafts and posts in general, max Ø 70 mm) with three light sources and white acrylic globes. Simple fitting and closing system ensures easy removal; specified for incandescent bulbs (max 40 W) or energy saving DULUX EL (max. 20W) Lampada L 72 cm per esterni (adatta per steli di ombrelloni e pali in genere, max Ø mm 70) a tre luci con diffusori a globo di acrilico bianco. Il sistema di aggancio e chiusura la rende facilmente rimovibile; può ospitare sia lampadine ad incandescenza (max 40W) che a risparmio energetico DULUX EL (max 20W) Lampe L 72 cm d'extérieur (pour mâts de parasols et autres supports max Ø 70 mm) à trois ampoules avec diffuseur globe en acrylique blanc. Le système d'accrochage et de verrouillage en facilite la manipulation; fonctionne avec des ampoules à incandescence (max 40W) ou des ampoules à économie d'énergie DULUX EL (max 20W). Außenleuchte B 72 cm (geeignet für Sonnenschirme oder andere Pfosten mit Ø 70 mm) mit drei weißen Acrylkugeln. Dank des Befestigungssystems kann die Leuchte problemlos angebracht und wieder abmontiert werden. Es können Leuchtmittel (bis zu 40W) und Energiesparlampen DULUX EL (bis zu 20W) verwendet werden.	Graphite / Grafite Graphite / Grafitgrau PI62GZAV
	Waterproof cover dark green in 50% polyester and 50% PVC, for Umbrellas Ref. QU98 - RO92 - RO4 Copertura impermeabile verde scuro di poliestere 50% e PVC 50% per ombrelloni Art. QU98 - RO92 - RO4 Housse imperméable vert foncé en 50% polyester et 50% PVC pour parasol Réf. QU98 - RO92 - RO4 Schutzhülle dunkelgrün aus 50% Polyester und 50% PVC für Sonnenschirme Art. QU98 - RO92 - RO4	PIE4PI62
	Waterproof cover dark green in 50% polyester and 50% PVC, for Umbrellas Ref. RE95 - QU4 - RE34 Copertura impermeabile verde scuro di poliestere 50% e PVC 50% per ombrelloni Art. RE95 - QU4 - RE34 Housse imperméable vert foncé en 50% polyester et 50% PVC pour parasol Réf. RE95 - QU4 - RE34 Schutzhülle dunkelgrün aus 50% Polyester und 50% PVC für Sonnenschirme Art. RE95 - QU4 - RE34	BASUN
	Waterproof cover dark green in 50% polyester and 50% PVC, for Umbrellas Ref. QU98 - RO92 - RO4 Copertura impermeabile verde scuro di poliestere 50% e PVC 50% per ombrelloni Art. QU98 - RO92 - RO4 Housse imperméable vert foncé en 50% polyester et 50% PVC pour parasol Réf. QU98 - RO92 - RO4 Schutzhülle dunkelgrün aus 50% Polyester und 50% PVC für Sonnenschirme Art. QU98 - RO92 - RO4	LAOM3
	Waterproof cover dark green in 50% polyester and 50% PVC, for Umbrellas Ref. RE95 - QU4 - RE34 Copertura impermeabile verde scuro di poliestere 50% e PVC 50% per ombrelloni Art. RE95 - QU4 - RE34 Housse imperméable vert foncé en 50% polyester et 50% PVC pour parasol Réf. RE95 - QU4 - RE34 Schutzhülle dunkelgrün aus 50% Polyester und 50% PVC für Sonnenschirme Art. RE95 - QU4 - RE34	CO1
	Waterproof cover dark green in 50% polyester and 50% PVC, for Umbrellas Ref. RE95 - QU4 - RE34 Copertura impermeabile verde scuro di poliestere 50% e PVC 50% per ombrelloni Art. RE95 - QU4 - RE34 Housse imperméable vert foncé en 50% polyester et 50% PVC pour parasol Réf. RE95 - QU4 - RE34 Schutzhülle dunkelgrün aus 50% Polyester und 50% PVC für Sonnenschirme Art. RE95 - QU4 - RE34	CO2

The umbrellas can be completely disassembled. It is possible to substitute any element including the shade without changing the entire structure, as is the case with most umbrella brands. Gli ombrelloni sono completamente smontabili. È possibile sostituire ogni elemento, compreso il telo, evitando di cambiare l'intera struttura, come avviene per gran parte degli ombrelloni in commercio.

Les parasols sont complètement démontables. Il est possible de remplacer chaque élément, toile comprise, évitant de remplacer l'entière structure comme pour la plupart des parasols en vente dans le commerce.

Die Sonnenschirme können komplett zerlegt werden. Es ist daher möglich jedes Element auszutauschen, inklusive des Bezuges (ohne dabei die komplette Struktur zu verändern, wie es ansonsten bei den meisten Sonnenschirmen der Fall ist.)

- Solid wood / Legno massello / Bois massif / Massivholz
- Aluminum / Alluminio / Aluminium / Aluminium
- Cement / Cemento / Béton / Beton
- Acrylic 100% / Acrílico 100% / 100% Acrylique / 100% Acryl
- Polyester 100% / Poliestere 100% / Polyester 100% / 100% Polyester

FINISHES / FINITURE / FINITIONS / AUSFÜHRUNGEN

	Aluminium graphite Alluminio grafite Aluminium graphite Aluminium grafitgrau	Concrete Cemento Béton Beton		Solid wood Legno massello Bois massif Massivholz
	100% acrylic off white 100% acrilico bianco grezzo 100% acrylique blanc écru 100% Baumwolle naturbelassen	100% acrylic cord 100% acrilico corda 100% acrylique corde 100% Acryl sandfarben		100% acrylic coffee 100% acrilico caffè 100% acrylique café 100% Acryl kaffefarben
	100% acrylic dove grey 100% acrilico tortora 100% acrylique gris torturelle 100% Acryl taubengrau	100% acrylic rust 100% acrilico ruggine 100% acrylique rouille 100% Acryl rostrot		
	100% polyester off white 100% poliestere bianco grezzo 100% polyester blanc 100% Polyester naturfarben	100% polyester cord 100% poliestere corda 100% polyester corde 100% Polyester sandfarben		

- Solid wood / Legno massello / Bois massif / Massivholz
- Aluminum / Alluminio / Aluminium / Aluminium
- Cement / Cemento / Béton / Beton
- Acrylic 100% / Acrílico 100% / 100% Acrylique / 100% Acryl
- Polyester 100% / Poliestere 100% / Polyester 100% / 100% Polyester

Manta

HEXAGONAL / ESAGONALE / HEXAGONAL / SECHSECKIG

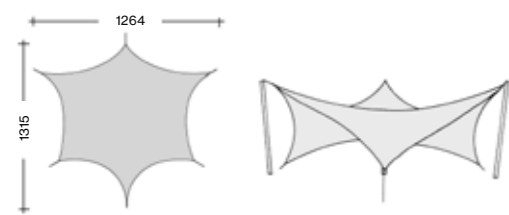

W 1264 D 1315

White PVC coated acrylic fabric / Tessuto acrilico spalmato di PVC bianco / Tissu acrylique enduit de PVC blanc
Acrylstoff mit weißer PVC-Beschichtung

Sail hexagonal including ropes, guy ropes, tension pegs and 3 lamellar wooden posts 9 x 9 H 400
Vela esagonale completa di cime, tiranti, picchetti tendicavo e 3 pali di legno lamellare 9 x 9 H 400
Voile hexagonale avec cordes, tirants, piquets tendeurs et 3 piliers en bois lamellé-collé 9 x 9 H 400
Segel sechseckig, komplett mit Seilen, Zugankern, Pflocken, Seilspannern und 3 Stützpfosten aus Schichtholz 9 x 9, H 400

W 1264 D 1315 MANTA

RHOMBOIDAL / ROMBOIDALE / VOILE LOSANGE / RAUTENFÖRMIG

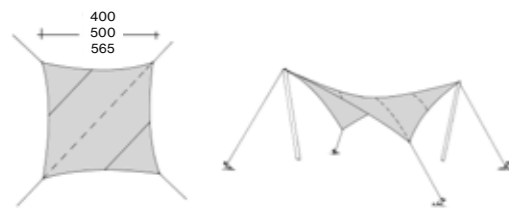

W 400 D 400 - W 500 D 500 - W 565 D 565

Acrylic fabric in ecru / Tessuto acrilico ecru / Tissu 100% acrylique de couleur écru / Weißer Acrylstoff

Sail rhomboidal including ropes, guy ropes, tension pegs and 2 wooden posts Ø 6,8 H 300
Vela romboidale completa di cime, picchetti, tendicorda e 2 pali di legno Ø 6,8 H 300
Voile losange avec cordes, piquets, tendeurs et 2 piliers en bois Ø 6,8 H 300
Segel rautenförmig, komplett mit Seilen, Pflocken, Seilspannern und 2 Stützpfosten aus Holz Ø 6,8, H 300

W 400 D 400 VEL4L
W 500 D 500 VEL5L
W 565 D 565 VEL6L

FINISHES / FINITURE / FINITIONS / AUSFÜHRUNGEN

 Treated pine wood
Legno di pino impregnato
Bois de pin traité
Imprägniertes Kiefernholz

 White PVC coated acrylic fabric
Tessuto acrilico spalmato di PVC bianco
Tissu acrylique enduit de PVC blanc
Acrylstoff mit PVC-Beschichtung weiß

 Acrylic fabric ecru
Tessuto acrilico ecru
Tissu acrylique écru
Weißer Acrylstoff

→ Treated pine wood / Legno di pino impregnato / Bois de pin traité / Imprägniertes Kiefernholz
→ White PVC coated acrylic fabric / Tessuto acrilico spalmato di PVC bianco / Tissu acrylique enduit de PVC blanc
Acrylstoff mit PVC-Beschichtung weiß
→ Acrylic fabric ecru / Tessuto acrilico ecru / Tissu 100% acrylique écru / Weißer Acrylstoff

Nagi

WALL-MOUNTED PERGOLA / PERGOLA ADDOSSATA / PERGOLA ADOSSÉE / ANBAUPERGOLA

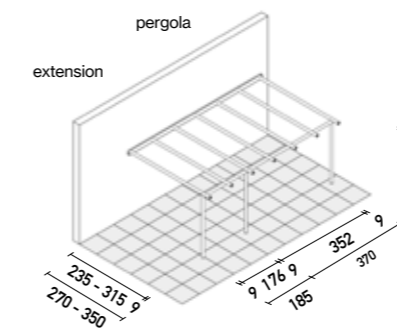

W 370 D 270 - 350

W 370 - Pergola / Pergola / Pergola / Pergola

D 270	PESADD43
D 350	PESADD44

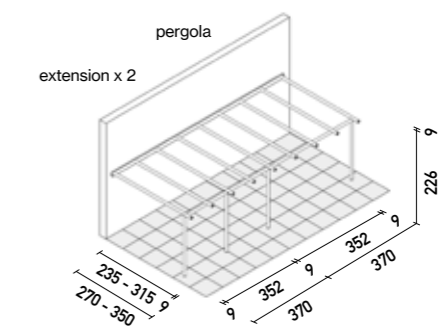

Extension / Estensione / Extension / Erweiterung

W 185 - Extension / Estensione / Extension / Erweiterung

D 270	ESPESADD43
D 350	ESPESADD44

FREESTANDING PERGOLA / PERGOLA AUTOPORTANTE / PERGOLA AUTOPORTANTE / FREI STEHENDE PERGOLA

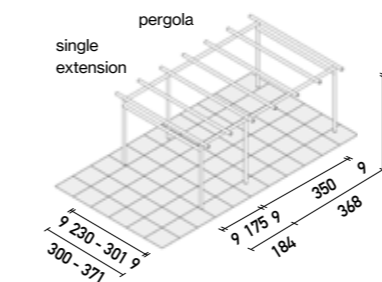

W 368 D 300 - 371

W 368 - Pergola / Pergola / Pergola / Pergola

D 300	PESAUT43
D 371	PESAUT44

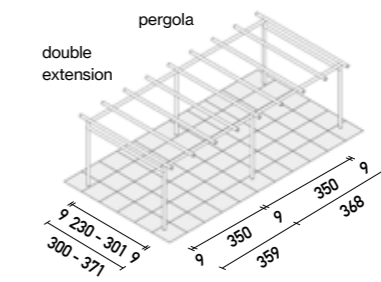

Extension / Estensione / Extension / Erweiterung

W 184 - Single extension Estensione singola
Extension simple / Einfache Erweiterung

D 300	ESPESAUT43
D 371	ESPESAUT44

W 359 - Double extension / Estensione doppia
Extension double / Doppelte Erweiterung

D 300	EDPESAUT43
D 371	EDPESAUT44

The structure is in treated Nordic pine and can be painted in dark walnut, teak or in colours from the Unopiù Colour range. The structure can be enclosed using infill components the Nagi range. / La struttura è in pino nordico impregnato e può essere tinteggiata nelle tonalità noce scuro, teak o nei colori della linea Unopiù Color. / La struttura può essere chiusa con gli elementi del sistema Nagi. / La structure est en pin nordique traité et peut être teintée dans les tonalités noyer foncé, teck ou dans les couleurs de la ligne Unopiù Color. La structure peut être fermée avec les éléments de la ligne Nagi. / Die Struktur ist aus imprägniertem, nordischem Kiefernholz und kann mit den Farben dunkelbraun, teakholzfarben oder den Farben der Serie Unopiù Color angestrichen werden. Dazu passend gibt es die Elemente der Kollektion Nagi.

→ Treated Nordic lamellar pine / Legno lamellare di pino nordico impregnato / Bois lamellé en pin nordique traité
Imprägniertes Brettschneittholz aus Kiefer

Nagi

TRELLISES / GRIGLIATI / TREILLAGES / TRENNGITTER



Diamond pattern / Maglia romboidale / Maille losange / Rautenmuster

	75 X 115	GRCRI711
	75 X 148	GRCRI714
	148 x 115	GRCRI1411
	148 X 148	GRCRI1414
	220 X 115	GRCRI2111
	220 X 148	GRCRI2114

Square pattern / Maglia quadrata / Maille carrée / Quadratisches Muster

	75 X 115	GRQU711
	75 X 148	GRQU714
	148 x 115	GRQU1411
	148 X 148	GRQU1414
	220 X 115	GRQU2111
	220 X 148	GRQU2114

RECTANGULAR FLOWER POTS / PORTAVASI RETTANGOLARI / POTS DE FLEURS RECTANGULAIRES / BLUMENKÄSTEN

	Flower pots for square post / Portavasi per palo quadrato Pots de fleurs pour pilier carré / Blumenkästen für Vierkantpfosten	L 75 W 45 H 44	FRSH7545
planter	Flower pots for round post / Portavasi per palo rotondo Pots de fleurs pour pilier rond / Blumenkästen für runde Pfosten	L 75 W 45 H 44	FRSH7545R
	Flower pots extension for square post / Estensione portavasi per palo quadrato Extension pots de fleurs pour pilier carré / Erweiterung Blumenkästen für Vierkantpfosten	L 69 W 45 H 44	ESFRSH7545
extension	Flower pots extension for round post / Estensione portavasi per palo rotondo Extension pots de fleurs pour pilier rond / Erweiterung Blumenkästen für runde Pfosten	L 69 W 45 H 44	ESFRSH7545R

ROLL SHADE / TELO ROLL / TOILE ROLL / SONNENSCHUTZROLLO

Compatible with Nagi pergolas supplied complete with aluminium casing, ivory gloss finish, spring loaded roller and tracks / Compatibile con la pergola Nagi viene fornito completo di coprirullo in alluminio smaltato di colore avorio, avvolgibile a molla e guide / Compatible avec la pergola Nagi fournie avec coffre rouleau en aluminium laqué ivoire, enrouleur à ressort et glissières
Kompatibel mit Nagi-Pergolen, komplett mit elfenbeinfarbener lackierter Blende aus Aluminium, Federzugmechanik und Schienen.

Adjustable shade 100% acrylic colour ecru Telo regolabile di acrilico 100% di colore ecru Toile réglable 100% acrylique couleur ecru Verstellbarer Sonnenschutz 100% Acryl ecru	W 372 D 400 (For pergola / Per pergola / Pour pergola / Für Pergola)	ROLLSH
	W 186 D 400 (For extension / Per estensione / Pour extension / Für Erweiterung)	ROLLSHE

For the white finish add the letter "W" in front of the article code e.g. WCOS45G

Per la finitura di colore bianco aggiungere la lettera "W" davanti al codice articolo es. WCOS45G

Pour la finition en blanc ajouter la lettre "W" devant le code de l'article, par exemple WCOS45G

Für die weiße Ausführung ergänzen Sie den Buchstaben "W" am Anfang der Artikelnummer, z.B. WCOS45G

→ Treated Nordic lamellar pine / Legno lamellare di pino nordico impregnato / Bois lamellé en pin nordique traité
Imprägniertes Brettschneittholz aus Kiefer

WOOD SLAT ROOFING / COPERTURA IN LISTELLI DI LEGNO / COUVERTURE EN LAMBRIS DE LATTES DE BOIS BEDACHUNG MIT HOLZLEISTEN

Panels of treated nordic pine wood slats with optional LED lighting / Pannelli a listelli di pino nordico impregnato con illuminazione a LED opzionale / Panneaux en lambris de lattes de bois en pin nordique imprégné avec illumination LED en option / Paneele aus behandelten nordischen Kiefernholzleisten mit optionaler LED-Beleuchtung.

LED characteristics: 13200mAh – 2700k – 600lm / Caratteristiche LED: 13200mAh - 2700k - 600lm / Caractéristiques LED : 13200mAh - 2700k - 600lm
LED Merkmale: 13200mAh – 2700k – 600lm

Recharge: solar – USB / Ricarica: solare - USB / Recharge: solaire - USB / Ladung: Sonne - USB



Slat roofing / Copertura a listelli / Couverture en lambris de lattes de bois / Bedachung mit Holzleisten

For pergola / Per pergola / Pour pergola / Für Pergola PESADD43	COADSH43
For extension / Per estensione / Pour extension / Für Erweiterung ESPESADD43	COADSH43ES
For pergola / Per pergola / Pour pergola / Für Pergola PESADD44	COADSH44
For extension / Per estensione / Pour extension / Für Erweiterung ESPESADD44	COADSH44ES
For pergola / Per pergola / Pour pergola / Für Pergola PESAUT43	COAUSH43
For single extension / Per estensione singola / Pour extension simple / Für einfache Erweiterung ESPESAUT43	COAUSH43ES
For double extension / Per estensione doppia / Pour double extension / Für doppelte Erweiterung EDPESAUT43	COAUSH43ED
For pergola / Per pergola / Pour pergola / Für Pergola PESAUT44	COAUSH44
For single extension / Per estensione singola / Pour extension simple / Für einfache Erweiterung ESPESAUT44	COAUSH44ES
For double extension / Per estensione doppia / Pour double extension / Für doppelte Erweiterungen EDPESAUT44	COAUSH44ED

Slat roofing with LED / Copertura a listelli con LED / Couverture en lambris de lattes de bois avec LED / Bedachung mit Leisten und LED

For pergola / Per pergola / Pour pergola / Für Pergola PESADD43 (n. 4 Led)	COADSH43LED
For extension / Per estensione / Pour extension / Für Pergola ESPESADD43 (n. 2 Led)	COADSH43ESLED
For pergola / per pergola / Pour pergola / Für Pergola PESADD44 (n. 4 Led)	COADSH44LED
For extension / Per estensione / Pour extension / Für Erweiterung ESPESADD44 (n. 2 Led)	COADSH44ESLED
For pergola / per pergola / Pour pergola / Für Pergola PESAUT43 (n. 4 Led)	COAUSH43LED
For single extension / Per estensione singola / Pour extension simple / Für einfache Erweiterung ESPESAUT43 (n. 2 Led)	COAUSH43ESLED
For double extension / Per estensione doppia / Pour double extension / Für doppelte Erweiterung EDPESAUT43 (n. 4 Led)	COAUSH43EDLED
For pergola / Per pergola / Pour pergola / Für Pergola PESAUT44 (n. 4 Led)	COAUSH44LED
For single extension / Per estensione singola / Pour extension simple / Für einfache Erweiterung ESPESAUT44 (n. 2 Led)	COAUSH44ESLED
For double extension / Per estensione doppia / Pour double extension / Für doppelte Erweiterung EDPESAUT44 (n. 4 Led)	COAUSH44EDLED

→ Treated Nordic lamellar pine / Legno lamellare di pino nordico impregnato / Bois lamellé en pin nordique traité
Imprägniertes Brettschneittholz aus Kiefer

Nagi - Wood Garden

Additional pillar for freestanding pergola Ø 88 H 245 / Pilastro aggiuntivo per pergola autoportante Ø 88 H 245 Pilier supplémentaire pour pergola autoportante Ø 88 H 245 / Zusätzlicher Pfosten für freistehende Pergola Ø 88 H 245	99PRO9245AGC
Adjustable bracket for fixing to ground / Staffa regolabile per fissaggio a terra Support réglable pour la fixation au sol / Verstellbarer Pfostenschuh für Bodenbefestigung	PIASAPR1
Half pillar H 215 wall fixing for trellises / Mezzo pilastro H 215 fissaggio a parete per tralicci Fixation murale demi-pilier H 215 pour trellis / Halber Pfosten H 215 als Wandbefestigung für Trenngitter	99PRO44215AGC
Additional pillar for attached pergola Ø 88 H 215 / Pilastro aggiuntivo per pergola adossata Ø 88 H 245 Pilier supplémentaire pour pergola adossée Ø 88 H 245 / Zusätzlicher Pfosten für Anbaupergola Ø 88 H 215	99PRO9215AGC
Additional beam for pergola PESADD43 Ø 88 H 232 / Trave supplementare per pergola PESADD43 Ø 88 H 232 Poutre supplémentaire pour pergola PESADD43 Ø 88 H 232 / Zusätzlicher Balken für Pergola PESADD43 Ø 88 H 232	99PRO9232AGC
Additional beam for pergola PESADD44 Ø 88 H 305 / Trave supplementare per pergola PESADD44 Ø 88 H 305 Poutre supplémentaire pour pergola PESADD44 Ø 88 H 305 / Additional beam for pergola PESADD44 Ø 88 H 305	99PRO9305AGC

		
Shade kit made with bamboo canes of varying diameter (from 1 to 2 cm) connected by a stainless steel wire. Kits are supplied complete with fittings / Kit di stuoie realizzate con canne di bambù di sezione variabile (da cm 1 a cm 2 ca.) e unite da un filo passante di acciaio inox. I kit sono completi di fissaggi / Kit de nattes en cannes de bambou de section variant de 1 à 2 cm, reliées par un fil d'acier inoxydable, avec fixations. Kit Bambusmatten, gefertigt aus Bambusstäben mit unterschiedlichem Schnittdurchmesser (von 1 cm bis ca. 2 cm), mit Edelstahldraht verwoben, komplett mit Befestigungsmaterial.		
Bamboo shades / Stuoie di canne di bambù / Nattes en cannes de bambou / Bambusmatten	W 185 D 250	BAMR
		
Compatible with the following pergola and extension codes / Abbinabili con i seguenti codici di pergole ed estensioni Peut être associée avec les codes suivants de pergolas et extensions / Passen zu folgenden Pergolen und Erweiterungen		
ESPESADD43 - ESPESADD44 - ESPESAUT43 - ESPESAUT44		COBAM3L
PESADD43 - PESAUT43 - EPESAUT43		COBAM4L
PESADD44 - PESAUT44 - ESPESAUT44		COBAM5L

		
Waterproof shade (29% polyester coated with 71% PVC) white for freestanding pergola Nagi / Telo impermeabile (poliester e 29% spalmato di PVC 71%) di colore bianco per pergola autoportante Nagi / Toile imperméable (29% polyester - enduit 71% PVC), blanche pour pergola autoportante Nagi / Wasserfeste, weiÙe Plane für frei stehende Pergola Nagi (29% Polyesterbeschichtung mit 71% PVC)		
For freestanding pergola Art. PESAUT44 / Per pergola autoportante Art. PESAUT44 / Pour pergola autoportante Ref. PESAUT44 Für freistehende Pergola Artikel Art. PESAUT44		TMSH44
With 1 extension / Con 1 estensione / Avec 1 extension / Mit einer Erweiterung		TMSH44E1
With 2 extension / Con 2 estensioni / Avec 2 extension / Mit zwei Erweiterungen		TMSH44E2

		
Waterproof shade (29% polyester coated with 71% PVC) white for freestanding pergola Nagi / Telo impermeabile (poliester e 29% spalmato di PVC 71%) di colore bianco per pergola autoportante Nagi / Toile imperméable (29% polyester - enduit 71% PVC), blanche pour pergola autoportante Nagi / Wasserfeste, weiÙe Plane für frei stehende Pergola Nagi (29% Polyesterbeschichtung mit 71% PVC)		
For freestanding pergola Art. PESAUT44 / Per pergola autoportante Art. PESAUT44 / Pour pergola autoportante Ref. PESAUT44 Für freistehende Pergola Artikel Art. PESAUT44		TMSH44
With 1 extension / Con 1 estensione / Avec 1 extension / Mit einer Erweiterung		TMSH44E1
With 2 extension / Con 2 estensioni / Avec 2 extension / Mit zwei Erweiterungen		TMSH44E2

		
Waterproof shade (29% polyester coated with 71% PVC) white for freestanding pergola Nagi / Telo impermeabile (poliester e 29% spalmato di PVC 71%) di colore bianco per pergola autoportante Nagi / Toile imperméable (29% polyester - enduit 71% PVC), blanche pour pergola autoportante Nagi / Wasserfeste, weiÙe Plane für frei stehende Pergola Nagi (29% Polyesterbeschichtung mit 71% PVC)		
For freestanding pergola Art. PESAUT44 / Per pergola autoportante Art. PESAUT44 / Pour pergola autoportante Ref. PESAUT44 Für freistehende Pergola Artikel Art. PESAUT44		TMSH44
With 1 extension / Con 1 estensione / Avec 1 extension / Mit einer Erweiterung		TMSH44E1
With 2 extension / Con 2 estensioni / Avec 2 extension / Mit zwei Erweiterungen		TMSH44E2

To order roofing for pergola with more than 2 extensions, substitute the "2" in the relative code for pergolas with 2 extensions with the number of those required (e.g. TSH44E3 - TMSH44E4)
Per ordinare coperture di pergole con più di 2 estensioni, sostituire il "2" nei codici relativi alle pergole con 2 estensioni con il numero di quelle previste (es. TMSH44E3 - TMSH44E4)
Pour commander les couvertures de pergolas ayant plus de 2 extensions, remplacer le "2" dans les codes de référence des pergolas à 2 extensions, avec le numéro des pergolas désirées (ex. TMSH44E3 - TMSH44E4) / Für Überdachungen für Pergolen mit mehr als 2 Erweiterungen ersetzen Sie die Nummer „2“ in der Artikelnummer mit der Anzahl der gewünschten Erweiterungen (z.B. TMSH44E3 - TMSH44E4).

	SL brackets: to fix any section to the ground, 10 Ø bolts and plugs are required / Staffe SL: per fissare a terra qualunque profilo, necessitano di bulloni Ø 10 e tasselli / Équerres SL : pour fixer au sol tous types de profilé : des boulons Ø 10 et des chevilles sont nécessaires. / Winkel SL: zur Befestigung von Profilhölzern am Boden. Zusätzlich werden Bolzen Ø 10 und Dübel verwendet. Winkel SLP: Universalwinkel verschieden einsetzbar.				
	SP30 screen brackets: to fix various panels to posts or walls. SRI-SBA: to fix posts to railings or balustrades / Staffe per schermature SP30N: per il fissaggio dei vari pannelli sia ai pilastri che a muro. SRI-SBA: per fissare i pilastri sia alla ringhiera che sulla balaustra / Équerres pour fermeture SP30, pour fixer différents panneaux aux piliers ou à la paroi. SRI - SBA, pour fixer les piliers à une rambarde ou balustrade. / Schraubprofile für Rankgitter: SP30-SP30M: um die verschiedenen Paneele an Pfosten bzw. an der Wand zu befestigen. SRI-SBA: um Pfosten am Geländer, bzw.an der Brüstung zu befestigen.				

↪ Treated Nordic lamellar pine / Legno lamellare di pino nordico impregnato / Bois lamellé en pin nordique traité
Imprägniertes Brettschmittholz aus Kiefer

	Nerved brackets in galvanized iron to fix 90 x 90 posts raised from the ground, complete with hardware. Plugs for fixing to the ground excluded. To be used only with attached structures / Staffa nervata rialzata in ferro zincato per il fissaggio sollevato da terra di pilastri 90 x 90 completa di ferramenta. Tasselli per l'ancoraggio a terra esclusi. Da utilizzare esclusivamente su strutture adossate / Equerre nervurée réhaussée en fer galvanisé pour fixation surélevée des piliers du sol 90 x 90, visserie incluse. Chevilles pour fixation au sol exclues. Utiliser uniquement pour structure adossée. / Balkenschuhe aus verzinktem Eisen zur erhöhten Befestigung von Pfosten 90 x 90 am Boden, komplett mit Eisenwaren, jedoch ohne Dübel zur Befestigung am Boden. Sie sind für die Anbaustrukturen zu gebrauchen	width	height	length	thickness	
		100	160	80	5	SRU99C

	Double raised brackets in galvanized iron to fix 90 x 90 and 70 x 70 posts raised from the ground. The brackets are complete with hardware Plugs to fix to ground are excluded / Staffe rialzate doppie in ferro zincato per il fissaggio sollevato da terra di pilastri 90 x 90 e 70 x 70. Le staffe sono complete di ferramenta. Tasselli per l'ancoraggio a terra esclusi / Equerre réhaussée doubles en fer galvanisé pour fixation surélevée des piliers du sol 90 x 90 et 70 x 70. Les équerres sont livrées avec visserie. Chevilles pour fixation au sol exclues. / Doppelte Balkenschuhe aus verzinktem Eisen zur erhöhten Befestigung von Pfosten 90 x 90 und 70 x 70 am Boden, komplett mit Eisenwaren, doch ohne Dübel zur Befestigung am Boden.	width	height	length	thickness	
		195	190	90	3	SRCD99C
		175	190	70	3	SRCD77C

	Clamps used to fix 90 x 90 (SINT) posts to the ground. Ref. SINT1 is used to fix square corner posts where structures are to be closed laterally / Zanche per fissare a terreno pilastri 90 x 90 (SINT). L'art. SINT1 si utilizza per il fissaggio a terra dei pilastri quadrati d'angolo in strutture da chiudere lateralmente / Support pour fixer au sol des piliers 90 x 90 (SINT). Le support Réf. SINT1 est utilisé pour la fixation au sol de piliers d'angle à section carrée dans les structures à fermer latéralement. / Um quadratische Pfosten 90 x 90 (SINT) am Boden zu befestigen. Pfostenanker SINT1: für die quadratischen Eckpfosten Systeme, die seitlich mit Paneelen geschlossen werden.	width	height	length	thickness	
		102	606	60	6	SINT
		102	606	60	6	SINT1
		102	606	60	6	SINTR

					
Available in 2100, 2200,2500 and 4000 mm, lengths and used as load bearing posts in almost all Unopiù structures ensuring optimum mechanical performance / Disponibili di lunghezza mm 2100, 2200,2500 e 4000, sono utilizzati come pilastri portanti in quasi tutte le strutture Unopiù e permettono di ottenere soluzioni meccaniche più spinte / Disponibles en 2100, 2200, 2500 et 4000 mm de longueur, ils sont utilisés comme piliers portants pour presque toutes les structures Unopiù et permettent de réaliser des solutions mécaniques plus solides. In den Längen von 2100, 2200, 2500 und 4000 erhältlich werden diese Leimholzpfosten als tragende Pfosten in fast allen Unopiù Konstruktionen benutzt, um so stabilere, mechanische Ergebnisse zu erzielen.		section	length		
		90 x 90	2200	PL9922V	
		90 x 90	2500	PL9925VC	
		90 x 90	4000	PL994VC	
		Ø68	2100	PR682SH	

	Available in various lengths and used as struts, in pairs, and as load bearing beams on structures with maximum spans of 4-5 m / Disponibili in diverse lunghezze si utilizzano come arcarecci e, in coppia, anche come travi portanti su strutture con luci massime di m 4 - 5 / Disponibles en plusieurs longueurs, ils sont utilisés comme chevrons et, accouplés, également comme poutres portantes sur des structures maximum de 4 - 5 m. / Sie sind in verschiedenen Längen erhältlich und werden als Balken oder paarweise als Tragpfosten für Systeme mit 4 bis 5 m Spannweite genutzt.	section	length		
		60 x 150	4490	L615449VC	
		60 x 150	5990	L6156VC	

	Available in various lengths and used with screens, for fixing panels or in the construction of light structures. / Disponibili di lunghezza mm 2700 e 5490, si usano come travi portanti su strutture con luci molto ampie, per evitare l'inserimento di pilastri intermedi. / Disponibles en 2700 et 5490 mm de longueur, ils s'utilisent comme poutres portantes dans des structures à grandes ouvertures pour éviter d'utiliser des piliers intermédiaires. / In den Längen von 2700 oder 5490 werden sie als Balken für die sehr großen Spannweiten der Systeme ohne Mittelpfosten genutzt.	section	length		
		90 x 150	2700	L915270VC	
		90 x 150	5490	L9155VC	

	Curved sections describing a quarter circle with a 2.40 m outer radius and used to create and personalize a wide range of applications. / Profili curvilinei pari ad un quarto di cerchio con raggio esterno di m 2,40, possono essere utilizzati per realizzare e personalizzare molte soluzioni. / Profilés courbés formant un quart de cercle avec rayon extérieur de 2,40 m, ils peuvent être utilisés pour réaliser et personnaliser de nombreuses solutions. / Die gebogenen Brettschnitthölzer entsprechen maßgenau dem Viertel eines Kreisbogens und haben einen Außenradius von 2,40. Sie können zur persönlichen Gestaltung verschiedener Konstruktionen verwendet werden.	section	length		
		90 x 90	2700	ARCOVC	

↪ Treated Nordic lamellar pine / Legno lamellare di pino nordico impregnato / Bois lamellé en pin nordique traité
Imprägniertes Brettschmittholz aus Kiefer

Wood Garden

SOLID POSTS / PILASTRI DI MASSELLO / PILIERS EN BOIS MASSIF / MASSIVHOLZPFOSTEN



Available in various lengths and used as struts, in pairs, and as load bearing beams on very light structures / Disponibili in diverse lunghezze sono utilizzati nelle schermature, per il fissaggio dei pannelli, o per ottenere strutture molto leggere / Disponibles en plusieurs longueurs, ils sont utilisés pour les clôtures, pour fixer les panneaux ou pour réaliser des structures très légères. Die Pfosten aus Massivholz sind in verschiedenen Längen erhältlich und werden beim Aufbau der Sichtschutzwände, zur Befestigung der Paneele und für sehr leichte Konstruktionen verwendet.

section	length	
70 x 70	2090	P7721V
70 x 70	1250	P7712FV



They are available in 3150, 3490, and 3830 mm lengths and can be used in max. 2.5 - 3 m spans. For longer spans they can be used in pairs and secured with relative hardware. Disponibili di lunghezza mm 3150, 3490 e 3830, si usano su luci massime di m 2,5 - 3. Per luci più ampie possono essere adoperate in coppia, per mezzo della relativa ferramenta. Disponibles en 3150, 3490 et 3830 mm, elles sont utilisées sur des ouvertures de 250 - 300 cm max. Pour des ouvertures plus grandes, les poutres peuvent s'utiliser accouplées, à l'aide des ferrures. / Die Balken sind in den Längen von 3150, 3490, und 3830 erhältlich und für Spannweiten bis zu 2,5 - 3 m geeignet. Für größere Spannweiten können zwei Balken mit den entsprechenden Metallteilen miteinander verbunden werden.

section	length	
45 x 117	3150	T4511315VC
45 x 117	3490	T4511349VC
45 x 117	3830	T4511383VC

SECTIONS / PROFILI / PROFILÉS / PROFILE



Special profiles used as either edging or trellis components, can also be used in many other applications. / Profili speciali utilizzati come doghe di rifinitura alcuni e come componenti dei grigliati gli altri, possono realizzare e rifinire anche molte altre soluzioni. / Profilés spéciaux utilisés en lattes de finition et en éléments de treillages, ils peuvent être utilisés également dans de nombreuses autres situations, pour réaliser et compléter de nombreuses solutions. Die Brettschnitthölzer werden als Zierleisten oder als Elemente der Rankgitter benutzt, bieten aber auch viele andere Gestaltungsmöglichkeiten.

section	length	
45 x 55	2090	PROUVC
22 x 95	1250	PAVDOG3VC

TRELLISES / GRIGLIATI / TREILLAGES / RANKGITTER

Diamond pattern / Maglia romboidale / Maille losange / Rautenmuster



53 x 115,5	R12NC
53 x 148,5	R13NC
53 x 177	R14NC
115,5 x 115,5	R22NC
115,5 x 148,5	R23NC
115,5 x 177	R24NC
148,5 x 148,5	R33NC
148,5 x 177	R34NC
177 x 177	R44NC

→ Treated Nordic lamellar pine / Legno lamellare di pino nordico impregnato / Bois lamellé en pin nordique traité
Imprägniertes Brettschnittholz aus Kiefer

Square pattern / Maglia quadrata / Maille carrée / Quadratisches Muster



53 x 115,5	GR12NC
53 x 148,5	GR13NC
53 x 177	GR14NC
115,5 x 115,5	GR22NC
115,5 x 148,5	GR23NC
115,5 x 177	GR24NC
148,5 x 148,5	GR33NC
148,5 x 177	GR34NC
177 x 177	GR44NC

Shade panels / Frangisole / Panneaux brise-soleil / Sonnenschutzpaneele



53 x 115,5	PFS12NC
53 x 148,5	PFS13NC
53 x 177	PFS14NC
115,5 x 115,5	PFS22NC
115,5 x 148,5	PFS23NC
115,5 x 177	PFS24NC
148,5 x 115,5	PFS32NC
148,5 x 148,5	PFS33NC
148,5 x 177	PFS34NC
177 x 115,5	PFS42NC
177 x 148,5	PFS43NC
177 x 177	PFS44NC

→ Treated Nordic lamellar pine / Legno lamellare di pino nordico impregnato / Bois lamellé en pin nordique traité
Imprägniertes Brettschnittholz aus Kiefer

Wood Garden

FLOWER POTS / PORTAVASI / POTS DE FLEURS / PLFANZKÄSTEN

Square flower pots / Portavasi quadrati / Pots de fleurs carrées / Quadratische Pflanzkästen

	53x53x44	FQ55NC
	60x60x44	FQ60NC

Rectangular flower pots / Portavasi rettangolari / Pots de fleurs rectangulaires / Rechteckige Pflanzkästen

	115,5x40x44	FR11540NC
	115,5x50x44	FR11550NC
	148,5x40x44	FR14840NC
	148,5x50x44	FR14850NC
	177x40x44	FR17740NC
	177x50x44	FR17750NC

SCREWS - PLUGS / VITI - TASSELLI / VIS - CHEVILLES / SCHRAUBEN - DÜBEL



Screws: galvanized and tropicalized, like all hardware, available in 3 sizes / Viti: tropicalizzate zincate, come il resto della ferramenta, sono disponibili in tre misure / Vis : tropicalisées et galvanisées comme toutes nos ferrures, trois mesures disponibles. / Schrauben: verzinkt und tropentauglich, wie alle Beschläge, verfügbar in 3 Größen

Ø	W	
6	100	V610
6	110	V611
6	130	V613



Plugs TE: plugs: 10 Ø, to fix wood to brickwork or concrete. TF: plugs: Ø 16 in steel, to fix any bracket to brick or concrete / Tasselli ad espansione. Tasselli TE: Ø 10, per fissare il legno a muratura e a cemento. Tasselli TF: elementi in acciaio Ø 16, per fissare a mattone pieno o cemento ogni staffa / Chevilles à expansion. Chevilles TE : Ø 10 pour fixer les éléments en bois à la maçonnerie et au ciment. Chevilles TF : éléments en acier Ø 16 pour fixer les équerres sur de la brique pleine ou du ciment. / Spreizdübel TE: Ø 10 mm, um Holzelemente an Mauer- oder Betonbauten zu befestigen. Dübel TF: Stahlelemente Ø 16 mm, um Beschläge auf Vollstein oder Beton zu befestigen.

Ø	W	
10	160	TE
16	80	TF



Chemical plugs: special plugs which can bond with any material (hollow bricks, tufa, etc). Supplied in packs of 6 with installation accessories / Tasselli chimici, speciali elementi che hanno la possibilità di far presa su qualsiasi tipo di materiale (forati, tufo, ecc.). Vengono forniti in confezioni da 6 pz., con gli accessori per l'installazione. Chevilles chimiques: pièces spéciales qui permettent de faire prise sur n'importe quel type de matériau (briques creuses, tuf, etc.), fournies en lots de 6 pièces avec accessoires pour la mise en place. / Chemische Spezialdübel. Spezialelemente, die in jedem Material haften (Loch-, Tuffstein usw.). Die Lieferung erfolgt in einer Sechserpackung, mit Zubehör zur Installation.

Ø	W	
16	110	TC6SP

→ Treated Nordic lamellar pine / Legno lamellare di pino nordico impregnato / Bois lamellé en pin nordique traité
Imprägniertes Brettschneittholz aus Kiefer

ACCESSORIES FOR TRELLISES / ACCESSORI PER GRIGLIATI / ACCESSOIRES POUR TREILLAGES / ZUBEHÖR FÜR RANGITTER



Crowning beam / Trave di coronamento / Poutre de couronnement / Abschlussleiste

W 4.5 x 9.5 x 400 T459539VC



Sphere / Sfera / Sphère / Kugel

Ø 7 SFE70V



Post for side support of various panels / Pilastro per il sostegno laterale dei vari pannelli
Pilier pour le soutien lateral des différents panneaux / Seitenpfosten zur Befestigung unterschiedlicher Paneele

H 210 P7721VC



Post for side support of various panels / Pilastro per il sostegno laterale dei vari pannelli
Pilier pour le soutien lateral des différents panneaux / Seitenpfosten zur Befestigung unterschiedlicher Paneele

H 125 P7712FV



Wooden dowel for fixing balustrade / Tassello in legno per fissaggio a balaustra
Ancre en bois pour fixage à balustrade / Distanzstück zur Befestigung am Mauerwerk

L 7 P 4 H 7 BDF4



Bracket to fix panel / Staffa fissaggio pannelli / Équerre de fixation panneaux / Schraubprofil für Paneele

SP30N

FINISHES / FINITURE / FINITIONS / AUSFÜHRUNGEN



Nordic pine painted in bankirai Colour
Pino nordico verniciato bankirai
Pin nordique peint en couleur bankirai
Nordische Kiefer bankirairfarben



Nordic pine painted in white colour
Pino nordico verniciato bianco
Pin nordique peint en couleur blanc
Nordische Kiefer weiß



Painted wooden slats
Listelli di legno verniciati
Lattes de bois vernis
Lackierte Holzleisten



Bamboo mat
Stuoia bambù
Natte de bambou
Bambusmatte



100% acrylic fabric in ecru
Tessuto acrilico 100% ecru
Tissu 100% acrylique écru
Ecrufarbener Stoff aus 100% Acryl



Waterproof fabric in 29% polyester coated with 71% PVC white
Telo impermeabile poliestere 29% PVC 71 %
Tissu imperméable 29% polyester enduit 71% PVC blanc
Wasserfeste, weiße Plane (29% Polyesterbeschichtung mit 71% PVC)

→ Treated Nordic lamellar pine / Legno lamellare di pino nordico impregnato / Bois lamellé en pin nordique traité
Imprägniertes Brettschneittholz aus Kiefer

Orangerie

FREESTANDING GREENHOUSE / SERRA AUTOPORTANTE / SERRE AUTOPORTANTE / FREI STEHENDES GEWÄCHSHAUS

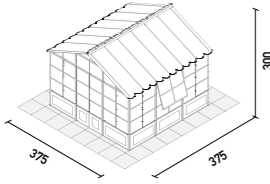

W 375 D 375 H 300

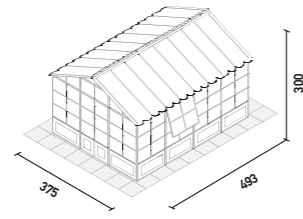

W 375 D 493 H 300

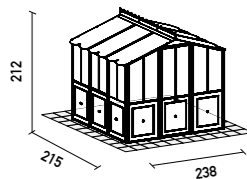

W 238 D 215 H 212

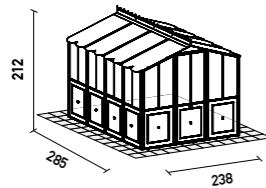

W 238 D 285 H 212

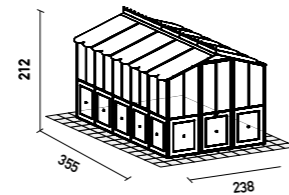

W 238 D 355 H 212

Greenhouse with polycarbonate roofing, 1 window and 1 door with polycarbonate side panelling
Serra con copertura di polycarbonato, 1 finestra e 1 porta con pannellatura laterale di polycarbonato
Serre avec couverture en polycarbonate gaufré, 1 fenêtre et 1 porte avec panneaux latéraux en polycarbonate / Gewächshaus mit Dach aus Polycarbonat, 1 Fenster, 1 Türe und Seitenverkleidung aus Polycarbonatplatten.

W 375 D 375 H 300 SAU33P

W 375 D 493 H 300 SAU34P

Greenhouse with 1 window and 1 door
Serra completa di 1 finestra e 1 porta
Serre complète avec 1 fenêtre et 1 porte
Gewächshaus mit 1 Fenster und 1 Tür

W 238 D 215 H 212 SAU215

W 238 D 285 H 212 SAU285

W 238 D 355 H 212 SAU355

Windows - Doors / Finestre - Porte / Fenêtres - Portes / Fenster - Türen

Supplement for additional window panel with polycarbonate panel (for SAU33P, SAU34P, SAD32P, SAD42P)
Supplemento per ulteriore pannello finestra con lastre di polycarbonato (per SAU33P, SAU34P, SAD32P, SAD42P)
Supplément pour panneau fenêtre supplémentaire avec plaques en polycarbonate (SAU33P, SAU34P, SAD32P, SAD42P)
Zusätzliches Fensterpaneel aus Polycarbonat (für SAU33P, SAU34P, SAD32P, SAD42P)

SPFSOR

Supplement for additional door panel with polycarbonate panel (for SAU33P, SAU34P, SAD32P, SAD42P)
Supplemento per ulteriore pannello porta con lastre di polycarbonato (per SAU33P, SAU34P, SAD32P, SAD42P)
Supplément pour panneau porte supplémentaire avec plaques en polycarbonate (SAU33P, SAU34P, SAD32P, SAD42P)
Zusätzliches Türpaneel aus Polycarbonat (für SAU33P, SAU34P, SAD32P, SAD42P)

SPPSOR

Supplement for additional window panel (for SAU215, SAU285, SAU355 SADSX215, SADDX215, SADSX285, SADDX285, SADSX355, SADDX355)
Supplemento per ulteriore pannello finestra (per SAU215, SAU285, SAU355 SADSX215, SADDX215, SADSX285, SADDX285, SADSX355, SADDX355)
Supplément pour panneau fenêtre supplémentaire (SAU215, SAU285, SAU355, SADSX215, SADDX215, SADSX285, SADDX285, SADSX355, SADDX355)
Zusätzliches Fensterpaneel (für SAU215, SAU285, SAU355 SADSX215, SADDX215, SADSX285, SADDX285, SADSX355, SADDX355)

SUPFINSER

→ Iron graphite / Ferro color grafite / Fer couleur graphite / Eisen grafitgrau
→ Polycarbonate embossed / Polycarbonato gofrato / Polycarbonate gaufré / Polycarbonat geprägt

WALL-MOUNTED GREENHOUSE / SERRA ADDOSSATA / SERRE ADOSSÉE / WANDMONTIERTES GEWÄCHSHAUS

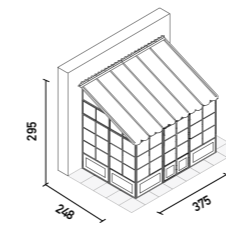

W 375 D 248 H 295

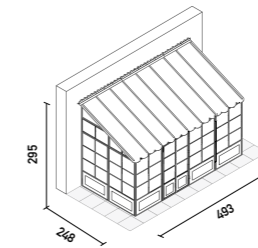

W 493 D 248 H 295

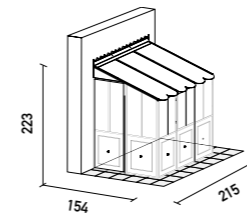

W 215 D 154 H 223

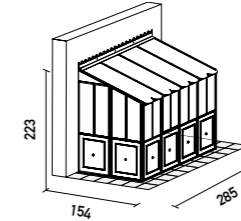

W 285 D 154 H 223

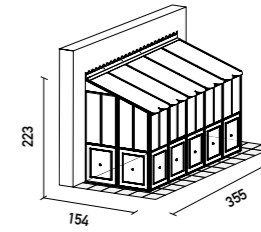

W 355 D 154 H 223

Greenhouse with polycarbonate roofing, 1 window and 1 door with polycarbonate side panelling
Serra con copertura di polycarbonato, 1 finestra e 1 porta con pannellatura laterale di polycarbonato
Serre avec couverture en polycarbonate, 1 fenêtre et 1 porte avec panneaux latéraux en polycarbonate
Gewächshaus mit Dach aus Polycarbonat, 1 Fenster, 1 Tür und Seitenverkleidung aus Polycarbonatplatten

W 375 D 248 H 295 SAD32P

W 493 D 248 H 295 SAD42P

Greenhouse with 1 window and 1 door left opening
Serra completa di 1 finestra e 1 porta apertura a sinistra
Serre complète avec 1 fenêtre et 1 porte ouverture à gauche
Gewächshaus mit 1 Fenster und 1 Tür (Öffnung nach links)

W 215 D 154 H 223 SADSX215

W 285 D 154 H 223 SADSX285

W 355 D 154 H 223 SADSX355

Greenhouse with 1 window and 1 door right opening
Serra completa di 1 finestra e 1 porta apertura a destra
Serre complète avec 1 fenêtre et 1 porte ouverture à droite
Gewächshaus mit 1 Fenster und 1 Tür (Öffnung nach rechts)

W 215 D 154 H 223 SADDX215

W 285 D 154 H 223 SADDX285

W 355 D 154 H 223 SADDX355

FINISHES / FINITURE / FINITIONS / AUSFÜHRUNGEN

● Iron graphite
Ferro color grafite
Fer couleur graphite
Eisen grafitgrau

● Polycarbonate embossed
Polycarbonato gofrato
Polycarbonate gaufré
Polycarbonat geprägt

→ Iron graphite / Ferro color grafite / Fer couleur graphite / Eisen grafitgrau
→ Polycarbonate embossed / Polycarbonato gofrato / Polycarbonate gaufré / Polycarbonat geprägt

Salento

UMBRELLAS / OMBRELLONI / PARASOLS / SONNENSCHIRME

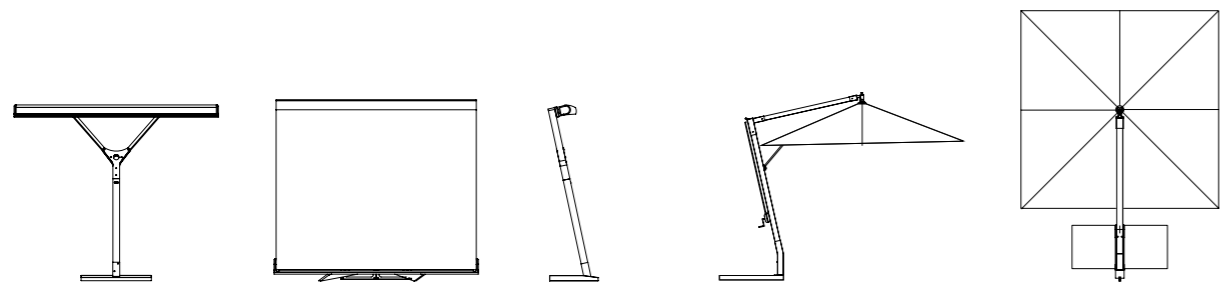

W 300 D 250 H 243

W 285 D 285 H 328

Umbrella in white steel and iroko wood with off white fabric, manual opening
 Ombrellone in acciaio bianco e legno di iroko con telo bianco grezzo, apertura manuale
 Parasol en acier galvanisé et thermolaqué blanc et bois d'iroko avec toile blanc écru, ouverture manuelle
 Sonnenschirm aus weißem Stahl und Irokoholz, mit weißem Schirm. Manuelles Öffnen

OSAMAB

Umbrella in bronze steel and iroko wood with cord fabric, manual opening
 Ombrellone in acciaio bronzo e legno di iroko con telo corda, apertura manuale
 Parasol en acier thermolaqué bronze et bois d'iroko avec toile corde avec toile blanche écru, ouverture manuelle
 Sonnenschirm aus bronzefarbenem Stahl und Irokoholz, mit ecrufarbenem Schirm. Manuelles Öffnen

OSAMABR

Umbrella in white steel and iroko wood with off white fabric, motorized opening
 Ombrellone in acciaio bianco e legno di iroko con telo bianco grezzo, apertura motorizzata
 Parasol en acier thermolaqué blanc et bois d'iroko avec toile blanc écru, ouverture motorisée
 Sonnenschirm aus weißem Stahl und Irokoholz, mit weißem Schirm. Motorbetriebenes Öffnen

OSAMOB

Umbrella in bronze steel and iroko wood with cord fabric, motorized opening
 Ombrellone in acciaio bronzo e legno di iroko con telo corda, apertura motorizzata
 Parasol en acier thermolaqué bronze et bois d'iroko avec toile corde, ouverture motorisée
 Sonnenschirm aus bronzefarbenem Stahl und Irokoholz, mit ecrufarbenem Schirm. Motorbetriebenes Öffnen

OSAMOBR

Umbrella square 285 x 285 H 328, side structure aluminium in white with off white fabric
 Ombrellone quadrato 285 x 285 H 328, struttura laterale alluminio bianco con telo bianco grezzo
 Parasol carré 285 x 285 H 328, structure latérale aluminium blanc avec toile blanc écru
 Quadratischer Schirm 285 x 285 H 328, Aluminiumgestell in der Farbe weiß, Bespannung naturweiß

OMABALB

Umbrella square 285 x 285 H 328, side structure aluminium in graphite with off white fabric
 Ombrellone quadrato 285 x 285 H 328, struttura laterale alluminio grafite con telo bianco grezzo
 Parasol carré 285 x 285 H 328, structure latérale aluminium graphite avec toile blanc écru
 Quadratischer Schirm 285 x 285 H 328, Aluminiumgestell in der Farbe grafitgrau, Bespannung naturweiß



OMABALG

Umbrella square 285 x 285 H 328, side structure aluminium wood effect with off white fabric
 Ombrellone quadrato 285 x 285 H 328, struttura laterale effetto legno con telo bianco grezzo
 Parasol carré 285 x 285 H 328, structure latérale aluminium effet bois avec toile blanc écru
 Quadratischer Schirm 285 x 285 H 328, Aluminiumgestell mit Holzeffekt lackiert







OMABALL

- ↳ Galvanized steel / Acciaio zincato / Acier thermolaqué / Verzinktes Stahl
- ↳ Lamellar iroko, wood / Legno lamellare di iroko / Bois d'iroko / Iroko-Leimholz
- ↳ Aluminum / Alluminio / Aluminium / Aluminium
- ↳ 100% acrylic fabric / Tessuto acrilico 100% bianco / 100% acrylique blanc / 100% Acryl

ACCESSORIES / ACCESSORI / ACCESSOIRES / ZUBEHÖR

	Set of 10 concrete blocks (for OSAMAB, OSAMABR OSAMOB, OSAMOBR) Set di 10 blocchi di cemento (per OSAMAB, OSAMABR, OSAMOB, OSAMOBR) Set de 10 dalles en ciment (pour OSAMAB, OSAMABR, OSAMOB, OSAMOBR) Set mit 10 Betonsplittplatten (für OSAMAB, OSAMABR OSAMOB, OSAMOBR)	OSABC
	Set of 6 tiles 50 x 50 in pebble concrete (for OMABALB, OMABALG, OMABALL) Set di 6 mattonelle 50 x 50 di cemento granigliato (per OMABALB, OMABALG, OMABALL) Set de 6 dalles de ciment granulé 50 x 50 (pour OMABALB, OMABALG, OMABALL) Set mit 6 Betonsplittplatten 50x50 cm (für OMABALB, OMABALG, OMABALL)	BAOMCAL
	Taupe coloured square umbrella, shade cover Copertura per telo ombrellone quadrato colore Taupe Housse pour toile parasol carré couleur Taupe Schutzhülle für quadratischen Sonnenschirm, taubengrau	COOMABALL

FINISHES / FINITURE / FINITIONS / AUSFÜHRUNGEN

	Aluminum graphite Alluminio grafite Aluminium graphite Aluminium grafitgrau		Aluminum wood effect Alluminio effetto legno Aluminium effet bois Aluminium in Holzoptik		Aluminum white Alluminio bianco Aluminium blanc Aluminium weiß
	Galvanized steel white gloss Acciaio zincato bianco lucido Acier thermolaqué blanc verni Verzinktes Stahl, glänzend weiß		Galvanized steel matt bronze Acciaio zincato bronzo Acier thermolaqué bronze Verzinktes Stahl, matt bronze		Lamellar iroko wood Legno lamellare iroko Bois d'iroko Iroko-Leimholz
	100% acrylic fabric in off white Tessuto acrilico 100% bianco grezzo Tissu 100% acrylique blanc écru Weißer Stoff aus 100% Acryl		100% acrylic fabric in cord Tessuto acrilico 100% corda Tissu 100% acrylique corde Ecrufarbener Stoff aus 100% Acryl		

- ↳ Galvanized steel / Acciaio zincato / Acier thermolaqué / Verzinktes Stahl
- ↳ Lamellar iroko, wood / Legno lamellare di iroko / Bois d'iroko / Iroko-Leimholz
- ↳ Aluminum / Alluminio / Aluminium / Aluminium
- ↳ 100% acrylic fabric / Tessuto acrilico 100% bianco / 100% acrylique blanc / 100% Acryl

Shibuya

WALL-MOUNTED PERGOLA / PERGOLA ADDOSSATA / PERGOLA ADOSSÉE / ANBAUPERGOLA

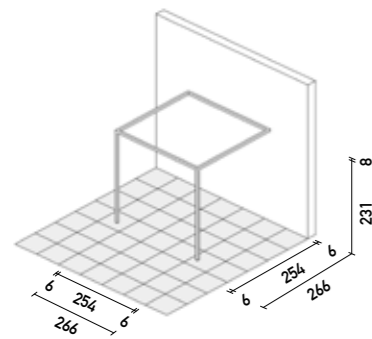

W 266 D 266

Wall-mounted pergola / Pergola addossata / Pergola adossée / Anbaupergola

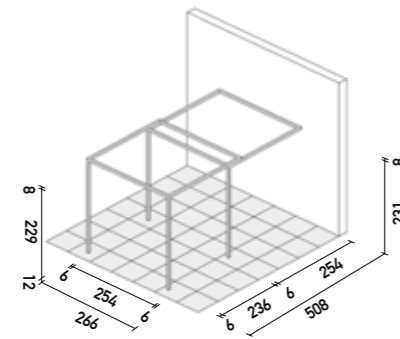

Extension / Estensione / Extension / Erweiterung

white / bianco / blanc / weiß SHI33ALADB

graphite / grafite / graphite / grafitgrau SHI33ALADG

FREESTANDING PERGOLA / PERGOLA AUTOPORTANTE / PERGOLA AUTOPORTANTE / FREI STEHENDE PERGOLA

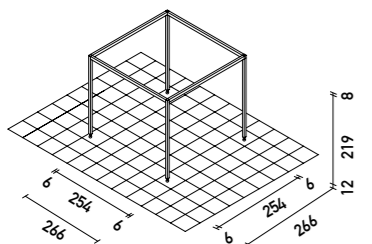

W 266 D 266

Freestanding pergola / Pergola autoportante / Pergola autoportante / Frei stehende Pergola

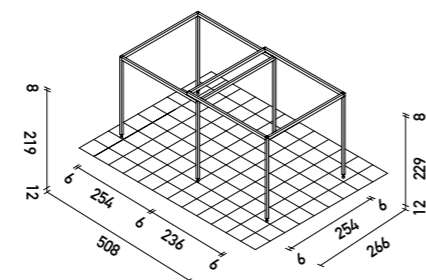

Extension / Estensione / Extension / Erweiterung

white / bianco / blanc / weiß SHI33ALB

graphite / grafite / graphite / grafitgrau SHI33ALG

EXTENSION / ESTENSIONE / EXTENSION / ERWEITERUNG / ERWEITERUNG

Extension for freestanding and attached pergola W 272.5 D 266

Estensione per pergola addossata e autoportante L 272.5 P 266

Extension pour pergola adossée et autoportante L 272.5 P 266

Erweiterung für frei stehende und Anbaupergola Breite 272.5 Tiefe 266

Fixing kit excluded / Kit di fissaggio escluso / kit de fixation exclu / Ohne Befestigungsmaterial

white / bianco / blanc / weiß SHI33ALESTB

graphite / grafite / graphite / grafit SHI33ALESTG

→ Aluminium powder coated / Alluminio verniciato a polveri / Aluminium galvanisé et thermolaqué / Aluminium pulverbeschichtet

MICROPERFORATED SHADE / TELO MICROFORATO / TOILE MICRO-PERFORÉE / MIKROPERFORIERTES TUCH

Structure colour / Colore struttura / Couleur structure / Gestellfarbe standard / base / base / basic extendable / estensibile / extensible / Erweiterung

White / Bianco / Blanc / Weiß SHICM3QAB SHICM3QABE

Graphite / Grafite / Graphite / Grafitgrau SHICM3QAG SHICM3QAGE

BAMBOO SHADE / STUOIE DI BAMBÙ / CANNES DE BAMBOU / BAMBUSMATTEN

Structure colour / Colore struttura / Couleur structure / Gestellfarbe standard / base / base / basic extendable / estensibile / extensible / Erweiterung

White / Bianco / Blanc / Weiß SHICB3QAB SHICB3QABE

Graphite / Grafite / Graphite / Grafitgrau SHICB3QAG SHICB3QAGE

WOODEN SLATS (PAINTED) / LISTELLI DI LEGNO (VERNICIATI) / LATTES DE BOIS (TRAITÉES) / BEHANDELTE HOLZLEISTEN (LACKIERT)

Structure colour / Colore struttura / Couleur structure / Gestellfarbe standard / base / base / basic extendable / estensibile / extensible / Erweiterung

White / Bianco / Blanc / Weiß SHICL3QAB SHICL3QABE

Graphite / Grafite / Graphite / Grafitgrau SHICL3QAG SHICL3QAGE

SIDE BLINDS / TENDE PERIMETRALI / STORES LATÉRAUX / SEITENROLLOS

Blind W 254 for white pergola

Tenda L 254 per la pergola di colore bianco

Store L 254 pour pergola couleur blanc

Rollo B 254 für weiße Pergola

SHITE3QB

Blind W 254 for pergola in graphite

Tenda L 254 per pergola di colore grafite

Store L 254 pour pergola couleur graphite

Rollo B 254 für grafitgraue Pergola

SHITE3QG

→ Aluminium powder coated / Alluminio verniciato a polveri / Aluminium galvanisé et thermolaqué / Aluminium pulverbeschichtet

Shibuya

ACCESSORIES / ACCESSORI / ACCESSOIRES / ACCESSOIRES / ZUBEHÖR

<p>Pair of brackets for fixing/blocking post-parapet/wall for fixed and mobile pergolas, white Coppia di staffe fissaggio/stazionamento pilastro-parapetto/muro per pergola fissa/mobile bianca Paire d'équerres pour fixation/stationnement pilier-parapet pour pergola fixe et mobile blanche 1 Paar Halterungen zur Befestigung / Fixierung von Pfosten an der Wand oder Brüstung, für festmontierte oder mobile Pergolen, Farbe weiß.</p>	STAPSHI2B
<p>Pair of brackets for fixing/blocking post-parapet/wall for fixed and mobile pergolas, graphite Coppia di staffe fissaggio/stazionamento pilastro-parapetto/muro per pergola fissa/mobile grafite Paire d'équerres pour fixation/stationnement pilier-parapet pour pergola fixe et mobile couleur graphite 1 Paar Halterungen zur Befestigung / Fixierung von Pfosten an der Wand oder Brüstung, für festmontierte oder mobile Pergolen, Farbe grafitgrau</p>	STAPSHI2G
<p>Pair of brackets for fixing/blocking post-railing for fixed and mobile pergolas, white Coppia di staffe fissaggio/stazionamento pilastro-ringhiera per pergola fissa/mobile bianca Paire d'équerres pour fixation/stationnement pilier-balustrade pour pergola fixe et mobile blanche 1 Paar Halterungen zur Befestigung / Fixierung von Pfosten am Geländer, für festmontierte oder mobile Pergolen, Farbe weiß.</p>	STARSHI2B
<p>Pair of brackets for fixing/blocking post-railing for fixed and mobile pergolas, graphite Coppia di staffe fissaggio/stazionamento pilastro-ringhiera per pergola fissa/mobile grafite Paire d'équerres pour fixation/stationnement pilier-balustrade pour pergola fixe et mobile couleur graphite 1 Paar Halterungen zur Befestigung / Fixierung von Pfosten am Geländer, für festmontierte oder mobile Pergolen, Farbe grafitgrau</p>	STARSHI2G
<p>Bracket removable to fix the mobile pergola to the ground (2 brackets are required per pergola), white Staffa removibile per posizionamento a terra pergola mobile (necessarie n. 2 staffe per pergola) bianca Équerre enlevable pour positionner la pergola mobile au sol (utiliser 2 équerres par pergola) blanche Bewegliches Profil zur Befestigung von Pfosten am Boden für bewegliche Pergola (für jede Pergola 2 Profile), Farbe weiß</p>	STATSHIB
<p>Bracket removable to fix the mobile pergola to the ground (2 brackets are required per pergola), graphite Staffa removibile per posizionamento a terra pergola mobile (necessarie n. 2 staffe per pergola) grafite Équerre enlevable pour positionner la pergola mobile au sol (utiliser 2 équerres par pergola) couleur graphite Bewegliches Profil zur Befestigung von Pfosten am Boden für bewegliche Pergola (für jede Pergola 2 Profile), Farbe grafitgrau</p>	STATSHIG
<p>Bracket in white for fixing to ground, white Staffa di fissaggio a terra bianca Équerre de fixation au sol blanche Pfostenschuh zur Befestigung der Pfosten am Boden für feste Pergolen, Farbe weiß</p>	SHISTAFB
<p>Bracket in white for fixing to ground, graphite Staffa di fissaggio a terra grafite Équerre de fixation au sol couleur graphite Pfostenschuh zur Befestigung der Pfosten am Boden für feste Pergolen, Farbe grafitgrau</p>	SHISTAFG
<p>Kit of 2 wheels Ø 10 Kit n. 2 ruote Ø 10 Kit de 2 roues Ø 10 Set mit 2 Rädern Ø 10</p>	KITRUSHI2

FINISHES / FINITURE / FINITIONS / AUSFÜHRUNGEN

	Aluminium powder coated graphite Alluminio verniciato a polveri grafite Aluminium galvanisé et thermolaqué graphite Pulverbeschichtetes Aluminium in grafitgrau		Aluminium powder coated white Alluminio verniciato a polveri bianco Aluminium galvanisé et thermolaqué blanc Pulverbeschichtetes Aluminium in weiß
	Ecrú microperforated sheet Telo ecru microforato Tôle microperforée écru Ecrufarbenes, mikroperforiertes Tuch		Bamboo mat Stuoia bambù Natte de bambou Bambusmatte
			Painted wooden slats Listelli di legno verniciati Lattes de bois vernis Lackierte Holzleisten

→ Aluminium powder coated / Alluminio verniciato a polveri / Aluminium galvanisé et thermolaqué / Aluminium pulverbeschichtet

Solaire

WALL-MOUNTED PERGOLA CURVED ROOF / PERGOLA ADDOSSATA CURVA / PERGOLA ADOSSÉE COURBÉE ANBAUPERGOLA MIT GESCHWUNGENEM DACH

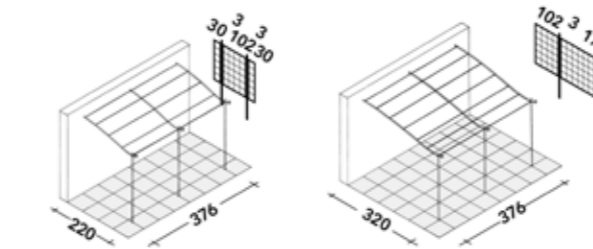

W 376 D 220 - 320

W 376 - Pergola / Pergola / Pergola / Pergola

D 220	PSW2C
D 320	PSW3C

W 186 - Extension / Estensione / Extension / Erweiterung

D 220	PSW2EC
D 320	PSW3EC

FREESTANDING PERGOLA CURVED ROOF / PERGOLA AUTOPORTANTE CURVA / PERGOLA AUTOPORTANTE COURBÉE FREI STEHENDE PERGOLA MIT GESCHWUNGENEM DACH

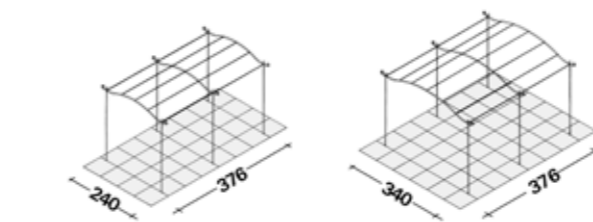

W 376 - 240 - 340

W 376 - Pergola / Pergola / Pergola / Pergola

D 240	PSA2C
D 340	PSA3C

W 186 - Extension / Estensione / Extension / Erweiterung

D 240	PSA2EC
D 340	PSA3EC

→ Iron graphite / Ferro grafite / Fer graphite / Eisen grafitgrau

Solaire

WALL-MOUNTED PERGOLA FLAT ROOF / PERGOLA ADDOSSATA PIANA / PERGOLA ADOSSÉE PLATE ANBAUPERGOLA MIT LINEAREM DACH

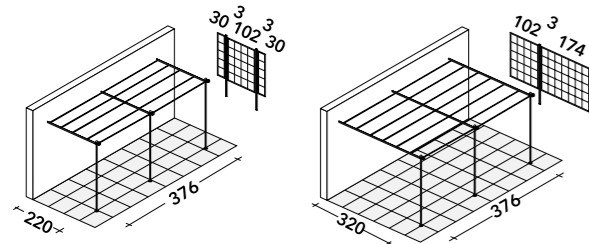

W 376 D 220 - 320

W 376 - Pergola / Pergola / Pergola / Pergola

D 220	PSP2C
D 320	PSP3C

W 186 - Extension / Estensione / Extension / Erweiterung

D 220	PSP2EC
D 320	PSP3EC

FREESTANDING PERGOLA FLAT ROOF / PERGOLA AUTOPORTANTE PIANA / PERGOLA AUTOPORTANTE PLATE FREI STEHENDE PERGOLA MIT LINEAREM DACH

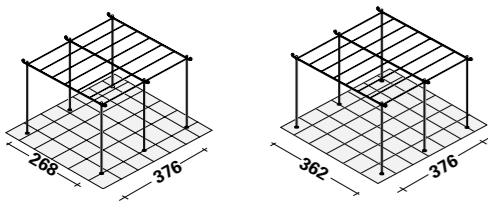

W 376 D 268 - 362

W 376 - Pergola / Pergola / Pergola / Pergola

D 268	PSAP2C
D 362	PSAP3C

W 186 - Extension / Estensione / Extension / Erweiterung

D 268	PSAP2EC
D 362	PSAP3EC

Dimensions given in the technical illustration refer to the maximum area occupied. The beam decoration overhangs the posts by approximately 20.5 cm in attached pergolas and by 18.5 cm in freestanding ones. Posts are Ø 3 cm H 250 cm. Thus the wall height of the curved attached pergola is: 280 cm for models 135 cm deep; 290 cm for models 220 cm deep; 310 cm for models 320 cm deep. Fixing kit excluded. /

Le misure riportate nei disegni si riferiscono agli ingombri massimi. Il decoro delle travi sporge rispetto ai pilastri di circa cm 20,5 nelle pergole addossate e di cm 18,5 in quelle autoportanti. I pilastri sono Ø cm 3 e H cm 250. La conseguente altezza a parete per le pergole addossate curve è di: cm 280 per il modello di profondità cm 135; cm 290 per il modello di profondità cm 220; cm 310 per il modello di profondità cm 320. Kit di fissaggio escluso. /

Les mesures reportées dans les dessins se réfèrent aux encombrements maximums. La décoration des travers dépassent d'environ 20,5 cm par rapport aux piliers pour les pergolas adossées et de 18,5 cm pour les pergolas autoportantes. Les piliers ont un Ø de 3 cm et H 250 cm. La hauteur conséquente au mur pour les pergolas adossées courbées est de : 280 cm pour le modèle de 135 cm de profondeur ; 290 cm pour le modèle de 220 cm de profondeur ; 310 cm pour le modèle de 320 cm de profondeur. kit de fixation exclu. /

Die in den Zeichnungen angegebenen Maße beziehen sich auf die Maximalmaße. Die Verzierung der Balken ragt bei Anbaupergolen ca. 20,5 cm und bei frei stehenden Pergolen ca. 18,5 cm über die Pfosten hinaus. Die Pfosten haben einen Durchmesser von 3 cm und eine Höhe von 250 cm. Die resultierende Wandhöhe für die gebogenen Pergolen beträgt: 280 cm für das 135 cm tiefe Modell; 290 cm für das 220 cm tiefe Modell; 310 cm für das 320 cm tiefe Modell. Befestigungssatz nicht im Lieferumfang enthalten. /

→ Iron graphite / Ferro grafite / Fer graphite / Eisen grafitgrau

FIXED SHADES / TELI FISSI / TOILES FIXES / FESTE PLANEN

Kit for waterproof shade white (39% polyester coated with 61% PVC), complete with fixing components / Kit telo impermeabile bianco (poliestere 39% spalmato di PVC 61%), completo di elementi di fissaggio / Kit toile imperméable blanc (39% polyester enduit de 61% PVC), avec éléments de fixation / Bausatz für wasserfeste, weiße Plane (39% beschichtetes Polyester mit 61% PVC)

For curved attached pergola, 220 cm deep / Per pergola addossata curva, cm 220 di profondità CO220

Pour pergola adossée courbée, de 220 cm de profondeur CO220 / Für geschwungene Anbaupergola, 220 Tiefe

CO220

With 1 extension / Con 1 estensione / Avec 1 extension / Mit einer Erweiterung

CO220E1

With 2 extensions / Con 2 estensioni / Avec 2 extensions / Mit zwei Erweiterungen

CO220E2

For curved attached pergola, 320 cm deep / Per pergola addossata curva, cm 320 di profondità CO320

Pour pergola adossée courbée, de 320 cm de profondeur CO320 / Für geschwungene Anbaupergola, 320 Tiefe

CO320

With 1 extension / Con 1 estensione / Avec 1 extension / Mit einer Erweiterung

CO320E1

With 2 extensions / Con 2 estensioni / Avec 2 extensions / Mit zwei Erweiterungen

CO320E2

For curved freestanding pergola, 240 cm deep / Per pergola autoportante curva, cm 240 di profondità CO240

Pour pergola autoportante courbée, de 240 cm de profondeur CO240 / Für geschwungene, frei stehende Pergola, 240 Tiefe

CO240

With 1 extension / Con 1 estensione / Avec 1 extension / Mit einer Erweiterung

CO240E1

With 2 extensions / Con 2 estensioni / Avec 2 extensions / Mit zwei Erweiterungen

CO240E2

For curved freestanding pergola, 340 cm deep / Per pergola autoportante curva, cm 340 di profondità CO340

Pour pergola autoportante courbée, de 340 cm de profondeur CO340 / Für geschwungene, frei stehende Pergola, 340 Tiefe

CO340

With 1 extension / Con 1 estensione / Avec 1 extension / Mit einer Erweiterung

CO340E1

With 2 extensions / Con 2 estensioni / Avec 2 extensions / Mit zwei Erweiterungen

CO340E2

To order roofing for pergolas with more than two extensions, substitute the "2" of the relative code of the pergola with two extensions, with the actual number of extensions (CO220E3 - CO220E4) Per ordinare coperture di pergole con più di 2 estensioni, sostituire il "2" nei codici relativi alle pergole con 2 estensioni con il numero di quelle previste (es. CO220E3 - CO220E4) Pour commander les couvertures des pergolas ayant plus de 2 extensions, remplacer le "2" dans les codes relatifs aux pergolas avec 2 extensions, avec le numéro des pergolas désirées (ex. CO220E3 - CO220E4)

Für Überdachungen für Pergolen mit mehr als 2 Erweiterungen ersetzen Sie die Nummer „2“ in der Artikelnummer mit der Anzahl der gewünschten Erweiterungen (Bsp. CO220E3 - CO220E4)

BAMBOO SHADES / STUOIE DI CANNE DI BAMBÙ / NATTES EN CANNES DE BAMBOU / BAMBUSMATTEN

Kit for bamboo shades made with bamboo canes of varying diameter (from 1 cm to 2 cm each) connected with a stainless steel wire. The kit includes fitting components / Kit di stuoie realizzate con canne di bambù di sezione variabile (da cm 1 a cm 2 ca.) e unite da un filo passante di acciaio inox. I kit sono completi di elementi di fissaggio / Kit de nattes réalisées en cannes de bambou de section variant de 1 cm à 2 cm environ et reliées par un fil en acier inoxydable. Eléments de fixation compris dans le kit. / Satz Bambusmatten gefertigt aus Bambusstäben mit variablem Schnittdurchmesser (von 1 cm bis ca. 2 cm), verbunden mit Inox-Edelstahldraht, komplett mit Befestigungsmaterial

Structure / Struture / Structures / Pergolen

PSA2EC - PSW2EC - PSP2EC - PSAP2EC

COBAM1

PSW2C - PSP2C - PSA2C - PSAP2C - PSW3EC - PSP3EC - PSA3EC - PSAP3EC - PSW3EC - PSP3EC
PSA3EC - PSAP3EC

COBAM2

PSW3C - PSP3C - PSA3C - PSAP3C

COBAM3

→ Iron graphite / Ferro grafite / Fer graphite / Eisen grafitgrau

Solaire

ROLL SHADES / TELI SCORREVOLI / TOILES COULISSANTES / FEDERZUGROLLOS

Kit for adjustable shade in 100% acrylic, colour écreu complete with powder coated aluminium casing, spring retractable mechanism with tracks, for attached pergolas and extensions / Kit telo regolabile di acrilico 100% colore écreu, completo di coprirullo di alluminio verniciato a polveri, avvolgibile a molla e guide, per pergole addossate ed estensioni / Kit toile réglable en 100% acrylique couleur écreu avec coffre pour rouleau en aluminium thermolaqué, enrouleur à ressort et glissières, pour pergolas adossées et extensions. / Bausatz für verschiebbare Bespannung aus 100% naturfarbenem Acrylstoff, komplett mit grafitgrau beschichteter Blende aus Aluminium, Federmechanik und Schienen für Anbaupergolen und Erweiterungen.

Kit for adjustable shade white (29% polyester coated with 71% PVC) complete with powder coated aluminium casing, graphite, spring retractable mechanism with tracks, for attached pergolas and extensions / Kit telo regolabile impermeabile bianco (poliestere 29% spalmato di PVC 71%), completo di coprirullo di alluminio verniciato a polveri grafite, avvolgibile a molla e guide, per pergole addossate ed estensioni / Kit toile réglable imperméable blanc (29% polyester enduit de 71% PVC), avec coffre pour rouleau en aluminium thermolaqué, enrouleur à ressort et glissières, pour pergolas adossées et extensions. / Bausatz für weiße wasserundurchlässige Tuchbespannung (29% Polyester - 71% PVC-Beschichtung), komplett mit grafitgrau beschichteter Blende aus Aluminium, Federmechanik und Schienen für Anbaupergolen und Erweiterungen.

Structure / Strutture / Structures / Pergolen

PSW2C	CORUS2
PSW2EC	CORUS2E
PSW3C	CORUS3
PSW3EC	CORUS3E
PSP2C	CORUSP2
PSP2EC	CORUSP2E
PSP3C	CORUSP3
PSP3EC	CORUSP3E

Structure / Strutture / Structures / Pergolen

PSW2C	CORUS2PVC
PSW2EC	CORUS2EPVC
PSW3C	CORUS3PVC
PSW3EC	CORUS3EPVC

PANELS IN DIAMOND PATTERN / PANNELLI A MAGLIA ROMBOIDALE / PANNEAUX MAILLE LOSANGE / PANELEE MIT RAUTENMUSTER

Grilles in iron with 13 x 13 cm perforated pattern in sheet metal with folded edges (W x H) / Grigliati di ferro con maglia di cm 13 x 13 in lamiera forata e bordo ripiegato (L x H) / Treillages en fer à mailles de 13 x 13 en tôle perforée et bord plié (L x H) / Gitter aus Eisen mit 13 x 13 cm großen Rauten aus Blech mit gefalteten Kanten (Breite / Höhe)

	30 x 102	GRFR12
	30 x 150	GRFR13
	102 x 102	GRFR22
	102 x 150	GRFR23
	174 x 102	GRFR42



PANELS IN SQUARE PATTERN / PANNELLI A MAGLIA QUADRATA / PANNEAUX MAILLE CARRÉE / PANELEE MIT QUADRATISCHEM MUSTER

Grilles in iron 23,2 x 23,2 cm square pattern of crisscrossed iron rods within a frame (W x H) / Grigliati di ferro con maglia di cm 23,2 x 23,2 in tondini di ferro sovrapposti e racchiusi in un telaio (L x H) / Treillages maille carrée 23,2 x 23,2 en barres de fer superposés et montées sur châssis (L x H) / Gitter aus Eisen 23,2 x 23,2 cm quadratisches Muster aus gekreuzten Eisenstäben innerhalb eines Rahmens (B x H)

	30 x 102	GRF12
	30 x 150	GRF13
	102 x 102	GRF22
	102 x 150	GRF23
	150 x 150	GRF33
	174 x 102	GRF42
174 x 150	GRF43	

CAPPING PIECES / ELEMENTO DI CORONAMENTO / COURONNEMENT / ZIERLEISTEN

Components Ø 2 in iron to fix between two posts, alone or with the relative grilles / Elementi Ø 2 di ferro da utilizzare tra due pilastri, da soli o con i rigliati corrispondenti / Éléments Ø 2 en fer à utiliser entre deux piliers, seuls ou avec les treillages correspondants / Eisenelemente Ø 2 zwischen zwei Pfosten, einzeln oder mit den entsprechenden Rankgittern (gerade)

Straight / Lineare / Linéaire / Gerade	Length / Lunghezza / Longueur / Länge	
	39	COF1L
	111	COF2L
	159	COF3L
	183	COF4L
Curved / Curvilineo / Arqué / Gebogen	Length / Lunghezza / Longueur / Länge	
	111	COF2C
	159	COF3C
	183	COF4C



→ Iron graphite / Ferro grafite / Fer graphite / Eisen grafitgrau

→ Iron graphite / Ferro grafite / Fer graphite / Eisen grafitgrau

Solaire

POSTS H 75 / PILASTRI H 75 / PILIERS H 75 / PFOSTEN HÖHE H 75



Post Ø 3 H 75 in iron with fixing bracket, bracket cover and ball finial decoration / Pilastro Ø 3 H 75 di ferro con staffa di fissaggio e copristaffa, decoro finale a sfera / Pilier Ø 3 H 75 en fer avec équerre pour fixation et cache pour équerre, boule d'ornement finale / Eisenpfosten Ø 3, 75 h mit Befestigungsprofil und Profillabdeckung, mit Kugeldecor mit Verbindungen zur Befestigung von Rankgittern

	*** Single with couplings for fixing grilles / *** Singolo con giunti per fissaggio grigliati *** Simple avec joints pour fixation des treillages / ***Einzel mit Verbindungen um Gitter zu befestigen	PFS75C
	Double with couplings for fixing grilles / Doppio con giunti per fissaggio grigliati Double avec joints pour fixation des treillages / Doppelt mit Verbindungen um Gitter zu befestigen	PFD75C

- (*) Single posts, couplings excluded, used to fix capping pieces, while single posts with couplings are used for bridging and creating openings.
- (**) Components can be cut to size, according to the width of the gap to be bridged.
- (***) Each post is fixed to the parapet using brackets with 3 masonry plugs Ref. TFP or with chemical plugs Ref. TC6SP according to the nature of the parapet.
- (*) I pilastri singoli, giunti esclusi, si utilizzano per il fissaggio di elementi di coronamento, mentre per gli elementi di compensazione e affaccio si utilizzano pilastri singoli con giunti.
- (**) Gli elementi possono essere tagliati su misura, in funzione del perimetro da schermare.
- (***) Il fissaggio di ogni pilastro singolo sul parapetto per mezzo della staffa avviene con 3 tasselli ad espansione Art. TFP o con tasselli chimici Art. TC6SP, da scegliere a seconda della natura del parapetto.
- (*) Les piliers simples, sans joints, s'utilisent pour la fixation des éléments de couronnement tandis que pour les éléments de compensation et de raccords utiliser des piliers simples avec joints.
- (**) Les éléments peuvent être découpés sur mesure, en fonction du périmètre à clôturer.
- (***) La fixation de chaque pilier simple au parapet à l'aide d'une équerre est faite avec 3 chevilles à expansion Réf. TFP ou avec des chevilles chimiques Réf. TC6SP en fonction du type de parapet.
- (*) Einzelpfosten, ohne Verbindungen, werden für die Befestigung von Zierleisten verwendet, während Einzelpfosten mit Verbindungen für Ausgleichselemente verwendet werden.
- (**) Die Elemente können nach Maß zugeschnitten werden, um eine Lücke auszufüllen
- (***) Die Pfosten werden am Mauerwerk mittels Profilen mit 3 Spreizdübeln Art. TFP oder mit chemischen Dübeln Art. TC6SP, je nach Beschaffenheit des Mauerwerks, befestigt.



POSTS H 260 / PILASTRI H 260 / PILIERS H 260 / PFOSTEN H 260

Post Ø 3 H 260 in iron with ball finial decoration / Pilastro Ø 3 H 260 di ferro con decoro finale a sfera / Piliers Ø 3 H 260 en fer avec boule d'ornement final / Pfosten Ø 3 H 260 aus Eisen mit einer dekorativen Kugel als Abschluss.

	Single with couplings for fixing grilles / Singolo con giunti per fissaggio grigliati / Simple avec joints pour fixation des treillages / Einzel mit Verbindungen zur Befestigung von Trenngittern	PFSG
	* Double with couplings for fixing grilles / * Doppio con giunti per fissaggio grigliati / * Double avec joints pour fixation des treillages / * Doppelt mit Verbindungen zur Befestigung von Trenngittern	PFDG
	Single, couplings not included / Singolo, giunti esclusi / Simple, joints exclus / Einfach, ohne Verbindungen	PFS

BRIDGE OPENING ** / COMPENSAZIONE - AFFACCIO ** / ÉLÉMENTS DE COMPENSATION - RACCORDS ** / AUSGLEICHSELEMENT **

Components including 2 capitals and 1 connecting piece in iron to bridge a gap and create an entrance / Elementi composti da 2 capitelli e 1 profilo di giunzione di ferro per realizzare zone di compensazione e affaccio / Éléments composés de 2 chapiteaux et d'un profilé de jonction en fer pour réaliser des zones de compensations et de raccords / Komponenten mit 2 Kapitellen und 1 Verbindungsstück aus Eisen, zur Überbrückung einer Lücke und um einen Eingang zu schaffen

	L 183	ECF183
	L 262	ECF262

→ Iron graphite / Ferro grafite / Fer graphite / Eisen grafitgrau

FITTING COMPONENTS / FISSAGGI / FIXATIONS / BEFESTIGUNGSELEMENTE / BEFESTIGUNGSELEMENTE

Bracket for fixing one post to the ground, complete with 3 plugs, Ø mm 10 / Staffa per fissaggio a terra di 1 pilastro, completa di 3 tasselli ad espansione, Ø mm 10 / Équerre pour fixer au sol 1 pilier, avec 3 chevilles à expansion Ø 10 mm / Befestigungsscheibe für einen Pfosten am Boden komplett mit 3 Spreizdübeln Ø 10 mm

SAPS

Hardware kit for fixing one panel to posts / Kit ferramenta per il fissaggio di un pannello ai pilastri / Paire d'équerres pour fixation d'un pilier
Beschlägeset zur Befestigung eines Panels an den Pfosten



EFP4

Pair of brackets for fixing post / Coppia di staffe per fissare il pilastro / Paire d'équerres pour fixation d'un pilier / Halterungen zur Befestigung von Pfosten



To masonry parapet / Al parapetto in muratura / À un parapet en maçonnerie
Profile zur Befestigung der Pfosten am Mauerwerk

SFP2



To iron railing / Alla ringhiera in ferro / À une balustrade en fer / Profile zur Befestigung der Pfosten am Eisengeländer

SFR2



Aluminium coupling for iron post / Giunto di alluminio per pilastro in ferro
Joint en aluminium pour pilier en fer / Aluverbindung für Eisenpfosten

G33NC

PAVILION / PADIGLIONE / GLORIETTE / PAVILLON

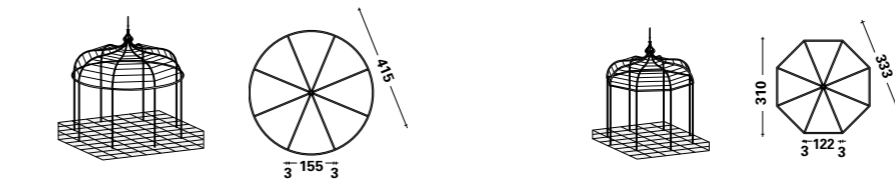

Ø 415 with 8 - round posts

octagonal side 122 (max Ø 333)

Pavilion round Ø 415 with 8 round posts Ø 3 H 250 in iron and galvanized steel wire
Rotondo Ø 415 con 8 pilastri rotondi Ø 3 di ferro e filo di acciaio zincato
Ronde Ø 415 avec 8 piliers ronds Ø 3 H 250 en fer et fil d'acier galvanisé
Pavillon rund Ø 415 mit 8 runden Eisenpfosten Ø 3, H 250 mit verzinktem Stahldraht

PATRR

Pavilion octagonal side 122 (max Ø 333) with 8 round posts Ø 3 H 250 in iron and galvanized steel wire
Padiglione ottagonale lato 122 (max Ø 333) con 8 pilastri rotondi Ø 3 H 250 di ferro e filo di acciaio zincato
Octogonale côté 122 cm (max Ø 333) avec 8 piliers ronds Ø 3 H 250 en fer et fil d'acier galvanisé
Pavillon achteckig Seitenlänge 122 (max. Ø 333) mit 8 runden Eisenpfosten Ø 3, H 250 mit verzinktem Stahldraht

PATRO

Grilles 102 cm wide are suitable for octagonal pavilions, and grilles 150 cm wide for round pavilions. Fixing kit excluded
Per il padiglione ottagonale sono adatti grigliati di larghezza cm 102; per il modello rotondo, grigliati di larghezza cm 150. Kit di fissaggio escluso
Pour les gloriettes octogonales choisir les treillages de 102 cm de largeur; pour les gloriettes rondes choisir les treillages de 150 cm de largeur. Kit de fixation exclu.
Für den achteckigen Pavillon eignen sich Trenngitter von 102 cm Breite; für das runde Modell Trenngitter von 150 cm Breite. Befestigungsmaterial nicht beinhaltet.

→ Iron graphite / Ferro grafite / Fer graphite / Eisen grafitgrau

Solaire

WATERPROOF COVERS / TELI DI COPERTURA / TOILE IMPERMÉABLES / WASSERUNDURCHLÄSSIGE TUCHBESpannung

Waterproof cover with fittings for pavilion Telo impermeabile con fissaggi Toile imperméable avec fixation Wasserundurchlässige Tuchbespannung mit Befestigungsmaterial für Pavillon	for round pavilion / per padiglione rotondo pour gloriette ronde / für runden Pavillon	TINTR
	for octagonal pavilion / per padiglione ottagonale pour gloriette octogonale / für achteckigen Pavillon	TINTO

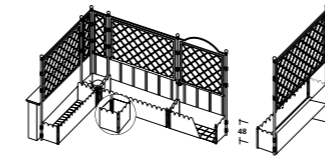



Wall-mounted Solaire planters must only be used with posts, grilles and the other accessories suggested on these and previous pages. 4 aluminium couplings Ref. G33NC, are necessary for fixing to posts, making the length of the planters 37, 109, 157 e 181 cm and respectively compatible with 30, 102, 150 e 174 cm grilles. A 42,5 x 42,5 cm corner unit is also available.

Le fioriere Solaire adossate devono essere utilizzate esclusivamente con i pilastri, i grigliati e gli altri accessori proposti in queste e nelle precedenti pagine. Per fissarle ai pilastri sono necessari 4 giunti in alluminio Art. G33NC che rendono le fioriere di lunghezza cm 37, 109, 157 e 181 compatibili rispettivamente con i grigliati di cm 30, 102, 150 e 174. È disponibile una variante d'angolo di cm 42,5 x 42,5.

Les jardinières Solaire adossées doivent être utilisées exclusivement avec les piliers, les treillages et les autres accessoires proposés dans ces pages. Pour les fixer aux piliers utiliser 4 joints en aluminium Réf. G33NC, p. 214 rendant ainsi compatibles, respectivement, les jardinières de 37, 109, 157 et 181 cm de longueur avec les treillages de 30, 102, 150 et 174 cm. Un modèle d'angle de 42,5 x 42,5 cm est également disponible. Die Anbaukästen Solaire sind nur mit den auf den vorhergehenden Seiten beschriebenen Pfosten, Rankgittern und Elementen zu verwenden. Um sie an den Pfosten zu befestigen, werden 4 Verbindungselemente aus Aluminium Art. G33NC benötigt, sodass die 37, 109, 157 und 181 breiten Blumenkästen zu den 30, 102, 150 und 174 langen Rankgittern passen. Es ist auch eine Eckversion von 42,5 x 42,5 cm erhältlich.

ACCESSORIES / ACCESSORI / ACCESSOIRES / ACCESSOIRES / ZUBEHÖR

	Coupling in aluminium for fixing iron grilles to pavilion / Giunto in alluminio per il fissaggio dei grigliati in ferro ai padiglioni / Joint en aluminium pour fixation des treillages en fer aux gloriettes / Aluverbindung für die Befestigung der Trenngitter aus Eisen an den Pavillon	G33NCT
	Hardware kit in aluminium for fixing 1 square or diamond pattern metal grille to octagonal pavilion / Kit ferramenta in alluminio per il fissaggio di 1 grigliato in ferro sia a maglia quadrata che romboidale al padiglione ottagonale / Kit pièces en aluminium pour fixation d'un treillage en fer à mailles carrées ou losanges à la gloriette octogonale / Beschläge-Set aus Aluminium für die Befestigung eines Trenngitters aus Eisen mit quadratischem Muster oder mit Rautenmuster am achteckigen Pavillon	EFP4TO
	Hardware kit in aluminium for fixing 1 iron diamond patterned grille to round pavilion / Kit ferramenta in alluminio per il fissaggio di 1 grigliato in ferro a maglia romboidale al padiglione rotondo / Kit pièces en aluminium pour fixation d'un treillage en fer à la gloriette ronde à maille losange / Beschlägeset aus Aluminium für die Befestigung eines Trenngitters mit Rautenmuster aus Eisen am runden Pavillon	EFPR4TR
	Hardware kit in aluminium for fixing 1 iron square patterned grille to round pavilion / Kit ferramenta in alluminio per il fissaggio di 1 grigliato in ferro a maglia quadrata al padiglione rotondo / Kit pièces en aluminium pour fixation d'un treillage en fer à la gloriette ronde à maille carrée / Beschlägeset aus Aluminium für die Befestigung eines Trenngitters mit quadratischem Muster aus Eisen am runden Pavillon	EFPQ4TR
	Bracket for fixing one post to the ground, complete with Ø 10 mm plugs / Staffa per fissaggio a terra di 1 pilastro, completa di 3 tasselli ad espansione Ø mm 10 / Équerre pour fixer au sol 1 pilier, avec 3 chevilles à expansion Ø 10 mm / Befestigungsscheibe für einen Pfosten am Boden komplett mit 3 Sprezdübeln Ø 10 mm	SAPS

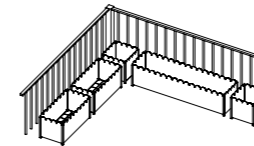

Freestanding planters can only be used as autonomous units and although compatible with items of the Collection, they cannot be affixed to them. Therefore they must be used as separate features or where grilles have already been installed.

Le fioriere Solaire autoportanti possono essere utilizzate solo come strutture autonome in quanto, pur essendo compatibili con gli elementi della collezione, non possono essere fissate ad essi. Devono essere quindi usate in modo indipendente o nel caso in cui i grigliati siano già stati fissati.

Les jardinières Solaire autoportantes peuvent être utilisées uniquement comme structures autonomes car bien qu'étant compatibles avec les éléments du Système, elles ne peuvent pas être fixées à ces dernières. Elles doivent donc être utilisées de façon indépendante ou dans le cas où les treillages aient déjà été fixés.

Die frei stehenden Pflanzkästen Solaire können nur als eigenständige Elemente verwendet werden, da sie nicht am System befestigt werden können, auch wenn sie zu den Elementen des Systems passen. Sie können überall dort eingesetzt werden, wo sie frei stehen oder wo die Trenngitter bereits befestigt wurden.

PLANTERS / FIORIERE / JARDINIÈRES / BLUMENKÄSTEN

	Wall-mounted / Adossate / Adossées / Anbau		
		37 x 42,5	FRS37
		42,5 x 42,5	FRS41
		109 x 42,5	FRS109
		157 x 42,5	FRS157
		181 x 42,5	FRS181

	Freestanding / Autoportanti / Autoportantes / Frei stehend		
		45 x 45	FARS45
		109 x 45	FARS109
		157 x 45	FARS157
		181 x 45	FARS181



FINISHES / FINITURE / FINITIONS / AUSFÜHRUNGEN

 Powder coated galvanized iron graphite
Ferro zincato verniciato a polveri grafite
Fer galvanisé enduit de poudre graphite
Verzinktes, pulverbeschichtetes Eisen grafitgrau

 White PVC sheet
Telo bianco PVC
Tôle PVC blanche
Weiße PVC Plane

 100% acrylic fabric in white
Tessuto acrilico 100% bianco
Tissu 100% acrylique blanc
Weißer Stoff aus 100% Acryl

 Bamboo mat
Stuoia bambù
Natte de bambou
Bambusmatte

→ Iron graphite / Ferro grafite / Fer graphite / Eisen grafitgrau

→ Iron graphite / Ferro grafite / Fer graphite / Eisen grafitgrau

Tibisco

FREESTANDING PERGOLA WITHOUT ROOFING* / PERGOLA AUTOPORTANTE SENZA COPERTURA* PERGOLA AUTOPORTANTE SANS COUVERTURE* / FREI STEHENDE PERGOLA OHNE BEDACHUNG*

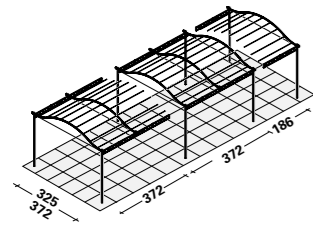

W 376 D 366 - 413

W 376 - Pergola / Pergola / Pergola / Pergola

D 366 **PEA366**

D 413 **PEA413**

W 186 - Extension / Estensione / Extension / Erweiterung

D 366 **EEA366**

D 413 **EEA413**

W 372 - Extension / Estensione / Extension / Erweiterung

D 366 **EEA366D**

D 413 **EEA413D**

Fixing kit excluded / Kit di fissaggio escluso / kit de fixation exclu / Ohne Befestigungsmaterial

WALL-MOUNTED PERGOLA WITHOUT ROOFING** / PERGOLA ADDOSSATA SENZA COPERTURA** PERGOLA ADOSSÉE SANS COUVERTURE** / ANBAUPERGOLA OHNE BEDACHUNG**

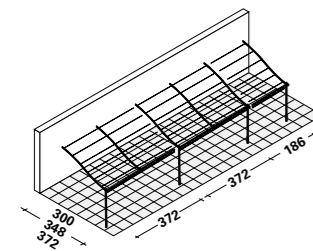

W 376 D 321 - 369 - 393

W 376 - Pergola / Pergola / Pergola / Pergola

D 321 **PE321**

D 369 **PE369**

D 393 **PE393**

W 186 - Extension / Estensione / Extension / Erweiterung

D 321 **EE321**

D 369 **EE369**

D 393 **EE393**

W 372 - Extension / Estensione / Extension / Erweiterung

D 321 **EE321D**

D 369 **EE369D**

D 393 **EE393D**

Fixing kit excluded / Kit di fissaggio escluso / kit de fixation exclu / Ohne Befestigungsmaterial

Maximum width to wall 385 cm. The relative measurements between posts are given in the technical illustration. The beam spirals overhang the posts by 18,5 cm.

L'ingombro totale a parete è di cm 385. Nei disegni sono riportate le misure di interesse tra i pilastri. Le volute delle travi sporgono di cm 18,5 rispetto ai pilastri.

L'encombrement total au mur est de 385 cm. Les mesures reportées dans les dessins sont les mesures entraxes des piliers. Les volutes des piliers dépassent de 18,5 cm par rapport aux piliers.

Das gesamte Richtmaß an der Wand beträgt 385 cm. In der Zeichnung sind die Maße für den Achsabstand zwischen den Pfosten angegeben. Die Voluten der Balken ragen 18,5 cm über die Pfosten hinaus.

→ Iron graphite / Ferro grafite / Fer graphite / Eisen grafitgrau

WALL-MOUNTED PERGOLA WITH POLYCARBONATE ROOF** / PERGOLA ADDOSSATA CON COPERTURA IN POLICARBONATO** PERGOLA ADOSSÉE AVEC COUVERTURE EN POLYCARBONATE** / ANBAUPERGOLA MIT BEDACHUNG AUS POLYKARBONAT**

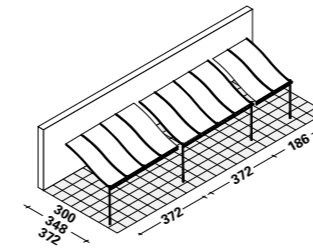

W 376 D 321 - 369 - 393

W 376 - Pergola / Pergola / Pergola / Pergola

D 321 **PE321PC**

D 369 **PE369PC**

D 393 **PE393PC**

W 186 - Extension / Estensione / Extension / Erweiterung

D 321 **EE321PC**

D 369 **EE369PC**

D 393 **EE393PC**

W 372 - Extension / Estensione / Extension / Erweiterung

D 321 **EE321DPC**

D 369 **EE369DPC**

D 393 **EE393DPC**

Fixing kit excluded / Kit di fissaggio escluso / kit de fixation exclu / Ohne Befestigungsmaterial

*Freestanding pergolas have 4 x 4 cm posts H 280 which must be fixed to the ground, set in concrete to a depth of 40 cm

*Le pergole autoportanti hanno pilastri di cm 4 x 4 h cm 280 che devono essere fissati a terra, cementandoli, per circa cm 40.

* Les pergolas autoportantes ont des piliers de 4 x 4 cm h 280 cm qui doivent être fixés au sol dans à peu près 40 cm de ciment.

*Die frei stehenden Pergolen verfügen über Pfosten von 4 x 4 cm, H 280 und müssen 40 cm tief in den Boden zementiert werden.

**Attached pergolas have 4 x 4 cm posts H 240 with a wall height of:

- 280 cm for models 321 cm deep;

- 285 cm for models 369 cm deep;

- 292 cm for models 393 cm deep.

**Le pergole addossate hanno pilastri di cm 4 x 4 H cm 240 con altezza a parete di:

- cm 280 per i modelli di profondità cm 321;

- cm 285 per i modelli di profondità cm 369;

- cm 292 per i modelli di profondità cm 393.

**Les pergolas adossées ont des piliers de 4 x 4 cm H 240 cm avec hauteur au mur de:

- 280 cm pour les modèles de 321 cm de profondeur ;

- 285 cm pour les modèles de 369 cm de profondeur ;

- 292 cm pour les modèles de 393 cm de profondeur.

**Die Anbaupergolen verfügen über Pfosten von 4 x 4 cm, H 240 cm mit der entsprechenden Höhe an der Wand

- 280 cm für die 321 cm tiefen Modelle;

- 285 cm für die 369 cm tiefen Modelle;

- 292 cm für die 393 cm tiefen Modelle.

→ Iron graphite / Ferro grafite / Fer graphite / Eisen grafitgrau

Tibisco

PAVILION / PADIGLIONE / GLORIETTE / PAVILLON

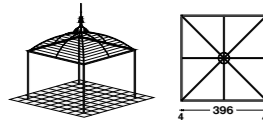

W 404 D 404 posts 4 x 4 H 280 / L 404 P 404 pilastri 4 x 4 H 280 / L 404 P 404 pilastri 4 x 4 H 280 / L 404 P 404 Pfosten 4 x 4 H 280

Pavilion complete with 4 posts 4 x 4 H 280 / Padiglione completo di 4 pilastri 4 x 4 H 280
Gloriette avec 4 piliers 4 x 4 H 280 / Pavillon komplett mit 4 Pfosten 4 x 4 H 280





PTD400

Waterproof cover / Telo impermeabile / Toile imperméable / Wasserundurchlässige Tuchbespannung

TPF400









Fixing kit excluded / Kit di fissaggio escluso / kit de fixation exclu / Ohne Befestigungsmaterial

ACCESSORIES / ACCESSORI / ACCESSOIRES / ACCESSOIRES / ZUBEHÖR

	Bracket for fixing 4 x 4 posts to the ground Staffa per il fissaggio a terra di pilastri 4 x 4 Équerre pour fixation piliers 4 x 4 cm au sol Pfostenschuh zur Befestigung der 4 x 4 Pfosten am Boden	SFPGS
	Pair of brackets for fixing 4 x 4 posts to parapet Coppia di staffe per il fissaggio a parapetto di pilastri 4 x 4 Paire d'équerres pour fixation de piliers 4 x 4 cm à parapet 2 Schraubprofile zur Befestigung der 4 x 4 Pfosten an der Brüstung	SFPQ2
	Pair of brackets for fixing 4 x 4 posts to railing Coppia di staffe per il fissaggio a ringhiera di pilastri 4 x 4 Paire d'équerres pour fixation de piliers 4 x 4 cm à garde-corps 2 Profile zur Befestigung der 4 x 4 starken Pfosten am Geländer	SFRQ2
	Set of 2 spandrels W 98 H 98 with fittings Set di 2 semiarchi L 98 H 98 con fissaggi Set de 2 arceaux L 98 H 98 avec fixations Set mit 2 Halbbögen aus Eisen B 98 H 98 mit Befestigungsmaterial	CAFER2
	Decorative base post H 30 with bracket for fixing to ground Decoro di base H 30 per pilastro con staffa di fissaggio a terra Décor pour base du pilier H 30 avec équerre pour fixation au sol Basisdekor H 30 für Eisenpfosten mit Befestigungsplatte	DBC

- Iron graphite / Ferro grafite / Fer graphite / Eisen grafitgrau

PRESTIGE COUPLING - FITTINGS / GIUNTO PRESTIGE - FISSAGGI / JOINT PRESTIGE - FIXATIONS / PRESTIGE VERBINDUNG UND BEFESTIGUNGEN

	Coupling Prestige 5,5 x 5,5 cm H 6 in aluminium with powder coated fittings in graphite, for fixing grilles and planters to 4 x 4 iron posts Giunto Prestige 5,5 x 5,5 H 6 cm di alluminio con fissaggi verniciati a polveri grafite, per fissare grigliati e fioriere a pilastri in ferro di 4 x 4 Joint Prestige 5,5 x 5,5 H 6 cm en aluminium avec fixations thermolaquées couleur graphite, pour fixer treillages et jardinières aux piliers en fer de 4 x 4 cm Aluverbindung Prestige mit Befestigungen, 5,5 x 5,5, H 6 grafitgrau pulverbeschichtet, um Trenngitter und Blumenkästen an 4 x 4 Pfosten zu befestigen	G55NC
	Kit of 4 components for fixing graphite iron grilles Kit di 4 elementi per fissaggio di grigliati in ferro Kit de 4 éléments pour fixer les treillages en fer, couleur graphite Set mit 4 Abstandhaltern für Rankgitter aus grafitgrauem Eisen	EFP4
	Bracket for fixing graphite iron grilles to the wall Staffa per il fissaggio a parete di grigliati in ferro Équerre pour fixer au mur les treillages en fer, couleur graphite Schraubprofil zur Befestigung der Trenngitter aus grafitgrauem Eisen an der Wand	SFPG
	Bracket for fixing 4 x 4 cm posts to the ground Staffa per il fissaggio a terra di pilastri 4 x 4 cm Équerre pour fixer au sol les piliers 4 x 4 cm Pfostenschuh zur Befestigung der 4 x 4 Pfosten am Boden	SFPGS
	Pair of brackets for fixing 4 x 4 cm posts to parapet Coppia di staffe per il fissaggio al parapetto di pilastri 4 x 4 cm Paire d'équerres pour fixer piliers 4 x 4 cm à parapet 2 Profile zur Befestigung der 4 x 4 starken Pfosten an der Brüstung	SFPQ2
	Pair of brackets for fixing 4 x 4 cm posts to railing Coppia di staffe per il fissaggio alla ringhiera di pilastri 4 x 4 cm Paire d'équerres pour fixer piliers 4 x 4 cm à la balustrade 2 Profile zur Befestigung der 4 x 4 starken Pfosten am Geländer	SFRQ2
	Post 4 x 4 H 240 cm in iron with fittings for fixing to decorated beam Pilastro 4 x 4 H 240 cm in ferro con fissaggi alla trave decorata Pilier 4 x 4 H 240 cm en fer avec fixations à la poutre décorée Eisenpfosten 4 x 4, 240 h mit Befestigungen am verzierten Träger	PQF
	Post 4 x 4 H 240 cm in iron with "ball" for Tibisco pergola Pilastro 4 x 4 H 240 cm in ferro con "sfera", per pergola Tibisco Pilier 4 x 4 H 240 cm en fer avec boule d'ornement, pour pergola Tibisco Eisenpfosten 4 x 4, 240 h mit Kugeldekor für Pergola Tibisco	PQS

- Iron graphite / Ferro grafite / Fer graphite / Eisen grafitgrau

Tibisco

FIXED SHADES / TELI FISSI / TOILES FIXES / FESTE PLANEN

Kit for waterproof shade white (39% polyester coated with 61% PVC), complete with fixing components for attached pergolas 321 cm deep Kit telo impermeabile bianco (poliestere 39% spalmato di PVC 61%), completo di elementi di fissaggio per pergola addossata, di profondità cm 321 Kit toile imperméable blanche (39% polyester enduit de 61% PVC), éléments de fixation inclus pour pergola adossée de 321 cm de profondeur Bausatz aus wasserdichter weißer Plane (39% Polyester mit 61% PVC-Beschichtung), komplett mit Befestigungsmaterial für Anbaupergola mit 321 cm Tiefe	CO321
Kit for waterproof shade white (39% polyester coated with 61% PVC), complete with fixing components for attached pergolas 321 cm deep with 1 extension Kit telo impermeabile bianco (poliestere 39% spalmato di PVC 61%), completo di elementi di fissaggio per pergola addossata, di profondità cm 321 con 1 estensione Kit toile imperméable blanche (39% polyester enduit de 61% PVC), éléments de fixation inclus pour pergola adossée de 321 cm de profondeur avec 1 extension Bausatz aus wasserdichter weißer Plane (39% Polyester mit 61% PVC-Beschichtung), komplett mit Befestigungsmaterial für Anbaupergola mit 321 cm Tiefe und einer Erweiterung	CO321E1
Kit for waterproof shade white (39% polyester coated with 61% PVC), complete with fixing components for attached pergolas 321 cm deep with 2 extension Kit telo impermeabile bianco (poliestere 39% spalmato di PVC 61%), completo di elementi di fissaggio per pergola addossata, di profondità cm 321 con 2 estensioni Kit toile imperméable blanche (39% polyester enduit de 61% PVC), éléments de fixation inclus pour pergola adossée de 321 cm de profondeur avec 2 extensions Bausatz aus wasserdichter weißer Plane (39% Polyester mit 61% PVC-Beschichtung), komplett mit Befestigungsmaterial für Anbaupergola mit 321 cm Tiefe und zwei Erweiterungen	CO321E2
Kit for waterproof shade white (39% polyester coated with 61% PVC), complete with fixing components for attached pergolas 369 cm deep Kit telo impermeabile bianco (poliestere 39% spalmato di PVC 61%), completo di elementi di fissaggio per pergola addossata, di profondità cm 369 Kit toile imperméable blanche (39% polyester enduit de 61% PVC), éléments de fixation inclus pour pergola adossée de 369 cm de profondeur Bausatz aus wasserdichter weißer Plane (39% Polyester mit 61% PVC-Beschichtung), komplett mit Befestigungsmaterial für Anbaupergola mit 369 cm Tiefe.	CO369
Kit for waterproof shade white (39% polyester coated with 61% PVC), complete with fixing components for attached pergolas 369 cm deep with 1 extension Kit telo impermeabile bianco (poliestere 39% spalmato di PVC 61%), completo di elementi di fissaggio per pergola addossata, di profondità cm 369 con 1 estensione Kit toile imperméable blanche (39% polyester enduit de 61% PVC), éléments de fixation inclus pour pergola adossée de 369 cm de profondeur avec 1 extension Bausatz aus wasserdichter weißer Plane (39% Polyester mit 61% PVC-Beschichtung), komplett mit Befestigungsmaterial für Anbaupergola mit 369 cm Tiefe und einer Erweiterung	CO369E1
Kit for waterproof shade white (39% polyester coated with 61% PVC), complete with fixing components for attached pergolas 369 cm deep with 2 extensions Kit telo impermeabile bianco (poliestere 39% spalmato di PVC 61%), completo di elementi di fissaggio per pergola addossata, di profondità cm 369 con 2 estensioni Kit toile imperméable blanche (39% polyester enduit de 61% PVC), éléments de fixation inclus pour pergola adossée de 369 cm de profondeur avec 2 extensions Bausatz aus wasserdichter weißer Plane (39% Polyester mit 61% PVC-Beschichtung), komplett mit Befestigungsmaterial für Anbaupergola mit 369 cm Tiefe und zwei Erweiterungen	CO369E2
Kit for waterproof shade white (39% polyester coated with 61% PVC), complete with fixing components for attached pergolas 393 cm deep Kit telo impermeabile bianco (poliestere 39% spalmato di PVC 61%), completo di elementi di fissaggio per pergola addossata, di profondità cm 393 Kit toile imperméable blanche (39% polyester enduit de 61% PVC), éléments de fixation inclus pour pergola adossée de 393 cm de profondeur Bausatz aus wasserdichter weißer Plane (39% Polyester mit 61% PVC-Beschichtung), komplett mit Befestigungsmaterial für Anbaupergola mit 393 cm Tiefe.	CO393
Kit for waterproof shade white (39% polyester coated with 61% PVC), complete with fixing components for attached pergolas 393 cm deep with 1 extensions Kit telo impermeabile bianco (poliestere 39% spalmato di PVC 61%), completo di elementi di fissaggio per pergola addossata, di profondità cm 393 con 1 estensione Kit toile imperméable blanche (39% polyester enduit de 61% PVC), éléments de fixation inclus pour pergola adossée de 393 cm de profondeur avec 1 extension Bausatz aus wasserdichter weißer Plane (39% Polyester mit 61% PVC-Beschichtung), komplett mit Befestigungsmaterial für Anbaupergola mit 393 cm Tiefe und einer Erweiterung	CO393E1
Kit for waterproof shade white (39% polyester coated with 61% PVC), complete with fixing components for attached pergolas 393 cm deep with 2 extensions Kit telo impermeabile bianco (poliestere 39% spalmato di PVC 61%), completo di elementi di fissaggio per pergola addossata, di profondità cm 393 con 2 estensioni Kit toile imperméable blanche (39% polyester enduit de 61% PVC), éléments de fixation inclus pour pergola adossée de 393 cm de profondeur avec 2 extensions Bausatz aus wasserdichter weißer Plane (39% Polyester mit 61% PVC-Beschichtung), komplett mit Befestigungsmaterial für Anbaupergola mit 393 cm Tiefe und zwei Erweiterungen	CO393E2
Kit for waterproof shade white (39% polyester coated with 61% PVC), complete with fixing components for freestanding pergolas 366 cm deep Kit telo impermeabile bianco (poliestere 39% spalmato di PVC 61%), completo di elementi di fissaggio per pergola autoportante, di profondità cm 366 Kit toile imperméable blanche (39% polyester enduit de 61% PVC), éléments de fixation inclus pour pergola autoportante de 366 cm de profondeur Bausatz aus wasserdichter weißer Plane (39% Polyester mit 61% PVC-Beschichtung), komplett mit Befestigungsmaterial für Anbaupergola mit 366 cm Tiefe	COA366
Kit for waterproof shade white (39% polyester coated with 61% PVC), complete with fixing components for freestanding pergolas 366 cm deep with 1 extension Kit telo impermeabile bianco (poliestere 39% spalmato di PVC 61%), completo di elementi di fissaggio per pergola autoportante, di profondità cm 366 con 1 estensione Kit toile imperméable blanche (39% polyester enduit de 61% PVC), éléments de fixation inclus pour pergola autoportante de 366 cm de profondeur avec 1 extension Bausatz aus wasserdichter weißer Plane (39% Polyester mit 61% PVC-Beschichtung), komplett mit Befestigungsmaterial für Anbaupergola mit 366 cm Tiefe und einer Erweiterung	COA366E1
Kit for waterproof shade white (39% polyester coated with 61% PVC), complete with fixing components for freestanding pergolas 366 cm deep with 2 extensions Kit telo impermeabile bianco (poliestere 39% spalmato di PVC 61%), completo di elementi di fissaggio per pergola autoportante, di profondità cm 366 con 2 estensioni Kit toile imperméable blanche (39% polyester enduit de 61% PVC), éléments de fixation inclus pour pergola autoportante de 366 cm de profondeur avec 2 extensions Bausatz aus wasserdichter weißer Plane (39% Polyester mit 61% PVC-Beschichtung), komplett mit Befestigungsmaterial für Anbaupergola mit 366 cm Tiefe und zwei Erweiterungen	COA366E2
Kit for waterproof shade white (39% polyester coated with 61% PVC), complete with fixing components for freestanding pergolas 413 cm deep Kit telo impermeabile bianco (poliestere 39% spalmato di PVC 61%), completo di elementi di fissaggio per pergola autoportante, di profondità cm 413 Kit toile imperméable blanche (39% polyester enduit de 61% PVC), éléments de fixation inclus pour pergola autoportante de 413 cm de profondeur Bausatz aus wasserdichter weißer Plane (39% Polyester mit 61% PVC-Beschichtung), komplett mit Befestigungsmaterial für freistehende Pergola mit 413 cm Tiefe.	COA413
Kit for waterproof shade white (39% polyester coated with 61% PVC), complete with fixing components for freestanding pergolas 413 cm deep with 1 extension Kit telo impermeabile bianco (poliestere 39% spalmato di PVC 61%), completo di elementi di fissaggio per pergola autoportante, di profondità cm 413 con 1 estensione Kit toile imperméable blanche (39% polyester enduit de 61% PVC), éléments de fixation inclus pour pergola autoportante de 413 cm de profondeur avec 1 extension Bausatz aus wasserdichter weißer Plane (39% Polyester mit 61% PVC-Beschichtung), komplett mit Befestigungsmaterial für Anbaupergola mit 413 cm Tiefe und einer Erweiterung	COA413E1
Kit for waterproof shade white (39% polyester coated with 61% PVC), complete with fixing components for freestanding pergolas 413 cm deep with 2 extensions Kit telo impermeabile bianco (poliestere 39% spalmato di PVC 61%), completo di elementi di fissaggio per pergola autoportante, di profondità cm 413 con 2 estensioni Kit toile imperméable blanche (39% polyester enduit de 61% PVC), éléments de fixation inclus pour pergola autoportante de 413 cm de profondeur avec 2 extensions Bausatz aus wasserdichter weißer Plane (39% Polyester mit 61% PVC-Beschichtung), komplett mit Befestigungsmaterial für Anbaupergola mit 413 cm Tiefe und zwei Erweiterungen	COA413E2

→ Iron graphite / Ferro grafite / Fer graphite / Eisen grafitgrau

BAMBOO SHADES / STUOIE DI CANNE DI BAMBÙ / NATTES EN CANNES DE BAMBOU / BAMBUSMATTEN

Kit for bamboo shades made with bamboo canes of varying diameter (from 1 cm to 2 cm each) connected with a stainless steel wire. The kit includes fitting components / Kit di stuoie realizzate con canne di bambù di sezione variabile (da cm 1 a cm 2 ca.) e unite da un filo passante di acciaio inox. Il kit sono completi di elementi di fissaggio / Kit de nattes en cannes de bambou (de diamètre variant de 1 cm à 2 cm) reliées par un fil d'acier inoxydable. Eléments de fixations inclus dans le kit. / Satz Bambusmatten gefertigt aus Bambusstäben mit variablem Schnittdurchmesser (von 1 cm bis ca. 2 cm), verbunden mit Inox-Edelstahldraht, komplett mit Befestigungsmaterial

Structure / Strutture / Structures / Pergolen	
EE321 - EE369 - EE393 - EEA366 - EEA413	COBAM2
PE321 - EE321D - PE369 - EE369D PEA366 - EEA366D	COBAM3
PE393 - EE393D - PEA413 - EEA413D	COBAM4

ROLL SHADES / TELI SCORREVOLI / TOILES COULISSANTES / SONNENSCHUTZROLLO

Kit for adjustable shade in 100% acrylic, écru, complete with powder coated aluminium casing, colour graphite, spring retractable mechanism with tracks, for attached pergolas and extensions. / Kit telo regolabile di acrilico 100% colore écru, coprinullo di alluminio verniciato a polveri grafite, avvolgibile a molla e guide, per pergole addossate ed estensioni. / Kit toile réglable 100% acrylique, couleur écru, coffre pour rouleau en aluminium thermolaqué, couleur graphite, enrouleur à ressort et glissières inclus, pour pergolas adossées et extensions. / Bausatz für verstellbaren Sonnenschutz aus 100% ecrufarbenem Acryl, komplett mit pulverbeschichtetem Aluminiumkasten in der Farbe graphit. Federzugmechanismus mit Laufschiene für angebaute Pergolen und Erweiterungen.

Structure / Strutture / Structures / Pergolen	
PE321	CRE32
EE321	CRE32ES
EE321D	CRE32ED
PE369	CRE36
EE369	CRE36ES
EE369D	CRE36ED
PE393	CRE39
EE393	CRE39ES
EE393D	CRE39ED

FINISHES / FINITURE / FINITIONS / AUSFÜHRUNGEN

	Powder coated galvanized iron graphite Ferro zincato verniciato a polveri grafite Fer galvanisé enduit de poudre graphite Verzinktes, pulverbeschichtetes Eisen grafitgrau		100% acrylic fabric in white Tessuto acrilico 100% bianco Tissu 100% acrylique blanc Weißer Stoff aus 100% Acryl		Bamboo mat Stuoia bambù Natte de bambou Bambusmatte
	White PVC shade Telo bianco PVC Tôle PVC blanche Weiße PVC Plane				

→ Iron graphite / Ferro grafite / Fer graphite / Eisen grafitgrau

Complements
Technical
Sheets

Aton
Carpets
Hotty
Jolly Cushions
Solare
Solar Shower
Tratto
Vases

Aton

FLOOR LAMPS / LAMPADE DA TERRA / LAMPADAIRE / BODENLEUCHTEN



ATAPB
White / Bianco / Blanc / Weiß



ATPIAB
White / Bianco / Blanc / Weiß



ATPAB
White / Bianco / Blanc / Weiß

ATAPBR
Bronze / Bronzo / Bronze / Bronze

ATPIA
Bronze / Bronzo / Bronze / Bronze

ATPABR
Bronze / Bronzo / Bronze / Bronze

WALL LAMPS / LAMPADE DA PARETE / APPLIQUES / WANDLEUCHTEN



ATAPMEB
White / Bianco / Blanc / Weiß



ATAPMEBR
Bronze / Bronzo / Bronze / Bronze

FINISHES / FINITURE / FINITIONS / AUSFÜHRUNGEN



Aluminum bronze
Alluminio bronzo
Aluminium bronze
Aluminium bronze



Aluminum white
Alluminio bianco
Aluminium blanc
Aluminium weiß

→ Aluminum / Alluminio / Aluminium / Aluminium

Carpets

PET CARPETS / TAPPETI PET / PET TAPIS / TEPPICHE AUS PET

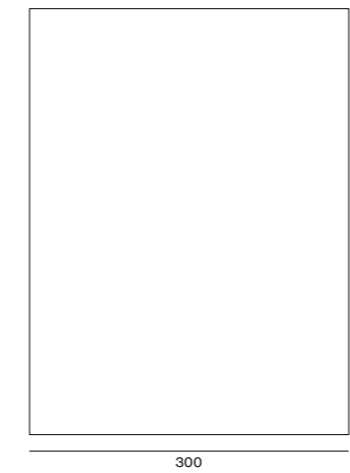

TAPETGRIS3X4
Dark grey / Grigio scuro / Gris foncé / Dunkelgrau

TAPETBLBI3X4
Blue white / Blu/bianco / Bleu blanc / Blau

TAPETTOME3X4
Mélange dove grey / Tortora mélange
Gris tourterelle chiné / Taubengrau meliert

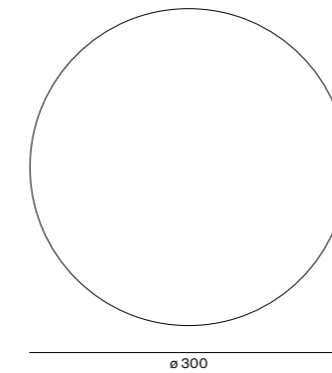

TAPETGRIS300R
Dark grey / Grigio scuro / Gris foncé / Dunkelgrau

TAPETBLBI300R
Blue white / Blu/bianco / Bleu blanc / Blau

TAPETTOME300R
Mélange dove grey / Tortora mélange
Gris tourterelle chiné / Taubengrau meliert

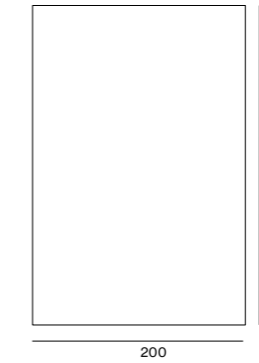

TAPETGRIS2x3
Dark grey / Grigio scuro / Gris foncé / Dunkelgrau

TAPETBLBI2x3
Blue white / Blu/bianco / Bleu blanc / Blau

TAPETTOME2x3
Mélange dove grey / Tortora mélange
Gris tourterelle chiné / Taubengrau meliert

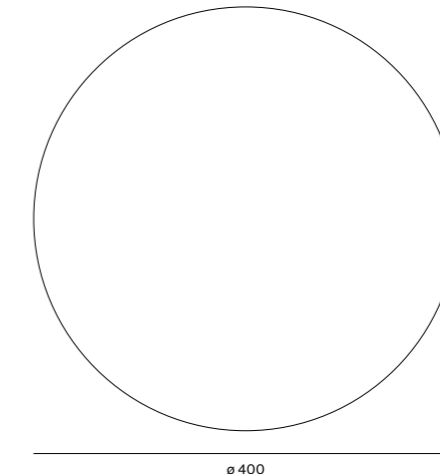

TAPETGRIS400R
Dark grey / Grigio scuro / Gris foncé / Dunkelgrau

TAPETBLBI400R
Blue white / Blu/bianco / Bleu blanc / Blau

TAPETTOME400R
Mélange dove grey / Tortora mélange
Gris tourterelle chiné / Taubengrau meliert

FINISHES / FINITURE / FINITIONS / AUSFÜHRUNGEN



Recycled PET dark grey
PET riciclato grigio scuro
PET recyclé gris foncé
Recycled PET dunkelgrau



Recycled PET mélange dove grey
PET riciclato tortora mélange
PET recyclé gris tourterelle chiné
Recycled PET taubengrau meliert



Recycled PET blue white
PET riciclato tortora blu bianco
PET recyclé bleu blanc
Recycled PET blau

→ Recycled PET / PET riciclato / PET recyclé / Recycled PET

Hotty

HEAT LAMP / LAMPADA SOLARE / LAMPE CHAUFFANTE / HEIZSTRAHLER

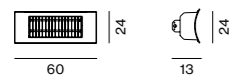

APPRIBI

White / Bianco / Blanc / Weiß

APPRINE

Graphite / Grafite / Graphite / Grafitgrau

STANDING LAMP / PIANTANA / STRUCTURE LAMPADAIRE / STANDFUSS

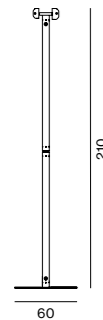

Standing Lamp / Piantana / Structure lampadaire / Standfuß für Heizstrahler

PIAPPRIBI

White / Bianco / Blanc / Weiß

PIAPPRINE

Graphite / Grafite / Graphite / Grafitgrau

COMPLEMENTS / COMPLEMENTI / COMPLÉMENTS / ZUBEHÖR

Remote controller

Telecomando

Télécommande

Fernbedienung

TEAPPRI

FINISHES / FINITURE / FINITIONS / AUSFÜHRUNGEN



Aluminum graphite
Alluminio grafite
Aluminium graphite
Aluminium grafitgrau



Aluminum white
Alluminio bianco
Aluminium blanc
Aluminium weiß



Stainless steel
Acciaio inox
Acier inoxydable
Edelstahl

→ Aluminum / Alluminio / Aluminium / Aluminium

→ Stainless steel / Acciaio inox / Acier inoxydable / Fuß aus Edelstahl

Jolly Cushions

CUSHIONS / CUSCINI / COUSSINS / KISSEN

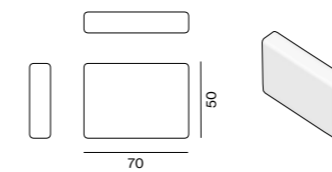

Removable cushion / Cuscino sfoderabile
Coussin déhoussable / Abziehbares Kissen
DECUR

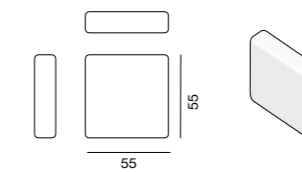

Removable cushion / Cuscino sfoderabile
Coussin déhoussable / Abziehbares Kissen
DECUG

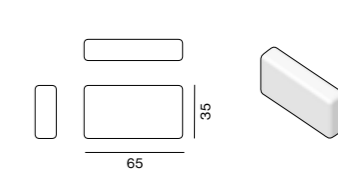

Removable cushion / Cuscino sfoderabile
Coussin déhoussable / Abziehbares Kissen
DECURP

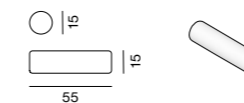

Removable cushion / Cuscino sfoderabile
Coussin déhoussable / Abziehbares Kissen
DECIL

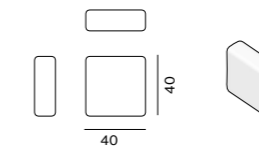

Set 4 removable cushion / Set 4 cuscini sfoderabili
Set 4 coussin déhoussable / Set mit 4 abziehbaren Kissen
DECUP

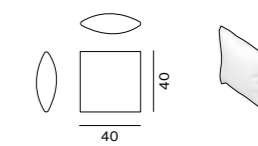

Set 5 removable cushion / Set 5 cuscini sfoderabili
Set 5 coussin déhoussable / Set mit 5 abziehbaren Kissen
DEJO

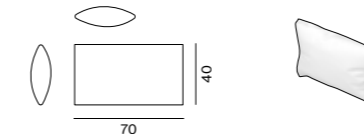

Removable cushion / Cuscino sfoderabili
Coussin déhoussable / Abziehbares Kissen
DEJOR

FINISHES / FINITURE / FINITIONS / AUSFÜHRUNGEN



Removable cushions Masterline Colour Collection pg. 302
Cuscini sfoderabili Masterline Colour Collection pg. 302
Coussins déhoussables Masterline Colour Collection pg. 302
Abziehbare Kissen aus der Masterline Kollektion Seite 302

→ Removable cushion / Cuscini sfoderabili / Coussin déhoussable / Abziehbare Kissen



LANTERNS / LANTERNE / LANTERNES / LATERNEN



LANATEBA Teak and graphite aluminium
Teak e alluminio grafite
Teck et aluminium graphite
Teakholz und grafitgraues Aluminium

LANITEBA Teak and stainless steel
Teak e acciaio inox
Teck et acier inoxydable
Teakholz und Edelstahl

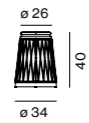

White aluminum / Alluminio bianco
Aluminium blanc / Weißes Aluminium

LANSOBI1 Salmon cord / Corda salmone
Corde salmon / Lachsfarbenes Seil
LANSOBI2 Blue Cord / Corda blu
Corde bleu / Blaues Seil

Graphite aluminum / Alluminio grafite
Aluminium graphite / Grafitgraues Aluminium

LANSOGR1 Blue cord / Corda blu
Corde bleu / Blaues Seil

LANSOGR2 Mustard cord / Corda mostarda
Corde moutarde / Senffarbenes Seil



LANTEQU Teak and graphite aluminium
Teak e alluminio grafite
Teck et aluminium graphite
Teakholz und grafitgraues Aluminium

FLOOR LAMPS / PIANTANE / LAMPADAIRES / BODENLEUCHTEN

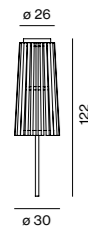

PITEAL Teak and graphite aluminium
Teak e alluminio grafite
Teck et aluminium graphite
Teakholz und grafitgraues Aluminium

PITEIN Teak and stainless steel
Teak e acciaio inox
Teck et acier inoxydable
Teakholz und Edelstahl

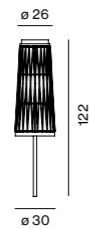

White aluminum / Alluminio bianco
Aluminium blanc / Weißes Aluminium

PIASOBI1 Salmon cord / Corda salmone
Corde salmon / Lachsfarbenes Seil
PIASOBI2 Blue Cord / Corda blu
Corde bleu / Blaues Seil

Graphite aluminum / Alluminio grafite
Aluminium graphite / Grafitgraues Aluminium

PIASOGR1 Blue cord / Corda blu
Corde bleu / Blaues Seil

PIASOGR2 Mustard cord / Corda mostarda
Corde moutarde / Senffarbenes Seil

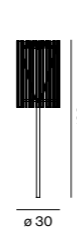

PIANTEQU Teak and graphite aluminium
Teak e alluminio grafite
Teck et aluminium graphite
Teakholz und grafitgraues Aluminium

Base not included, see on the opposite page / Basi non incluse vedi nella pagina accanto
Choix du pied de la lampe à la page suivante / Leuchtenfuß nicht enthalten, siehe nebenstehende Seite

- Teak slats / Listelli di Teak / Lattes de teck / Holzleisten aus Teak
- Aluminum / Alluminio / Aluminium / Aluminium
- Polyolefin cord / Corda poliolefinica / Corde en polyoléfine / Polyolefin Seil
- LED 13200mAh - 2700k - 600 lm

COMPLEMENTS / COMPLEMENTI / COMPLÉMENTS / ZUBEHÖR

Graphite aluminum base	Base in alluminio grafite	Base en aluminium graphite	Fuß aus Aluminium Farbe graphit	PIELA30FE
White aluminum base	Base in alluminio bianco	Base en aluminium blanc	Fuß aus Aluminium Farbe weiß	PIELA30FEB
Stainless steel base	Base in acciaio inox	Base en acier inoxydable	Fuß aus Edelstahl	PIELA30IN
Spike in stainless steel	Picca in acciaio inox	Pique en i acier inoxydable	Erdspieß aus Edelstahl	PICPIASO
Bracket for anchoring to cement	Staffa per ancoraggio al cemento	Support pour ancrage au béton	Halterung zur Verankerung in Beton	PIECESO

FINISHES / FINITURE / FINITIONS / AUSFÜHRUNGEN

 Aluminum graphite Alluminio grafite Aluminium graphite Aluminium grafitgrau	 Stainless steel Acciaio inox Acier inoxydable Fuß aus Edelstahl	 Aluminum white Alluminio bianco Aluminium blanc Aluminium weiß
 Polyolefin cord blue Corda poliolefinica blu Corde en polyoléfine bleu Polyolefin Seil in der Farbe Blau	 Polyolefin cord salmon Corda poliolefinica salmone Corde en polyoléfine salmon Polyolefin Seil in der Farbe Lachs	 Polyolefin cord mustard Corda poliolefinica mostarda Corde en polyoléfine moutarde Polyolefin Seil in der Farbe Senf
 Teak slats Listelli di Teak Lattes de Teck Holzleisten aus Teak		

- Teak slats / Listelli di Teak / Lattes de teck / Holzleisten aus Teak
- Aluminum / Alluminio / Aluminium / Aluminium
- Polyolefin cord / Corda poliolefinica / Corde en polyoléfine / Polyolefin-Seil
- LED 13200mAh - 2700k - 600 lm

Solar Shower

SHOWER / DOCCIA / DOUCHE / DUSCHE

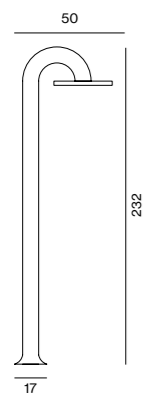

Solar Shower / Doccia solare
Douche solaire / Solardusche

DOFUN

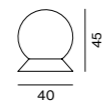

Hot ball / Hot ball / Hot ball capteur solaire
Hot ball Solarkollektor

HOBADOFUN

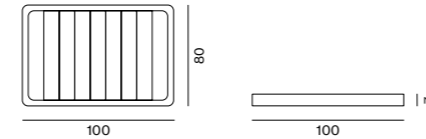

Shower tray / Piatto doccia
Receveur de douche / Duschwanne

PIADOFUN

FINISHES / FINITURE / FINITIONS / AUSFÜHRUNGEN



Black resin
Resina nera
Résine noire
Schwarzes Kunstharz



Aluminum
Alluminio
Aluminium
Aluminium



Okumé wood
Legno di okumé
Bois d'okumé
Okumè-Holz

- Black resin / Resina nera / Résine noire / Schwarzes Kunstharz
- Aluminum / Alluminio / Aluminium / Aluminium
- Okumé wood / Legno di okumé / Bois d'okumé / Okumè-Holz

Tratto

FLOOR LAMPS / LAMPADE DA TERRA / LAMPADAIRE / BODENLEUCHTEN

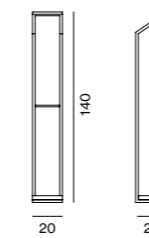

LANTRAL Standing lamp / Piantana
Lampadaire / Stehlampe

LANTRAL

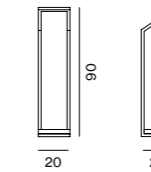

LANTRME Lantern / Lanterna
Lanterne / Laterne

LANTRME

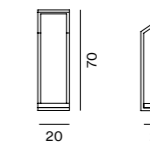

LANTRBA Lantern / Lanterna
Lanterne / Laterne

LANTRBA

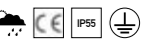

WALL LAMP / LAMPADA DA PARETE / APPLIQUE / WANDLEUCHTE

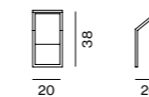

LANTRAPP Wall lamp / Applique
Applique / Wandleuchte

LANTRAPP

FINISHES / FINITURE / FINITIONS / AUSFÜHRUNGEN



Powder coated galvanized iron graphite
Ferro zincato verniciato a polveri grafite
Fer galvanisé enduit de poudre graphite
Verzinktes, pulverbeschichtetes Eisen grafitgrau

Vases

GLAZED STONEWARE VASES / VASI SMALTATI IN GRÈS / VASES EN GRÈS ÉMAILLÉ / TÖPFE AUS GLASIERTEM STEINGUT

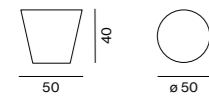

kg 23

VAG4050PR
Burgundy / Prugna
Prune / Pflaumenblau

VAG4050GI
Yellow / Giallo
Jaune / Gelb

VAG4050VO
Olive green / Verde oliva
Olive vert / Olivgrün

VAG4050BL
Blue / Blu / Bleu / Blau

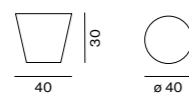

kg 12

VAG3040PR
Burgundy / Prugna
Prune / Pflaumenblau

VAG3040GI
Yellow / Giallo
Jaune / Gelb

VAG3040VO
Olive green / Verde oliva
Olive vert / Olivgrün

VAG3040BL
Blue / Blu / Bleu / Blau

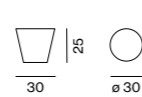

kg 7

VAG2530PR
Burgundy / Prugna
Prune / Pflaumenblau

VAG2530GI
Yellow / Giallo
Jaune / Gelb

VAG2530VO
Olive green / Verde oliva
Olive vert / Olivgrün

VAG2530BL
Blue / Blu / Bleu / Blau



kg 4

VAG2023PR
Burgundy / Prugna
Prune / Pflaumenblau

VAG2023GI
Yellow / Giallo
Jaune / Gelb

VAG2023VO
Olive green / Verde oliva
Olive vert / Olivgrün

VAG2023BL
Blue / Blu / Bleu / Blau

CONCRETE VASES / VASI IN CEMENTO / VASES EN BÉTON

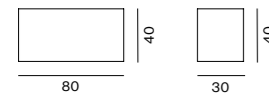
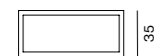

kg 31

VACE408035
Concrete / Cemento / Béton / Beton

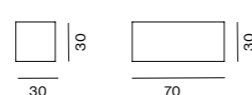
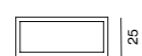



kg 17

VACE307030
Concrete / Cemento / Béton / Beton

FINISHES / FINITURE / FINITIONS / AUSFÜHRUNGEN

 Glazed stoneware blue
Gres smaltato blu
Grès émaillé bleu
Glasiertes Steingut blau

 Glazed stoneware burgundy
Gres smaltato prugna
Grès émaillé prugne
Glasiertes Steingut pflaumenblau

 Concrete
Cemento
Béton
Beton

 Glazed stoneware yellow
Gres smaltato giallo
Grès émaillé jaune
Glasiertes Steingut gelb

 Glazed stoneware green
Gres smaltato verde
Grès émaillé vert
Glasiertes Steingut grün

→ Glazed stoneware / Gres smaltato / Grès émaillé / Glasiertes Steingut
→ Concrete / Cemento / Béton / Beton

Protection Covers

Covers for AGORÀ	
Sofa	C237
Armchair	C130
Lounge and End modules	C162
Corner module	C10668
Backrest module	C74106
Sunlounger	C216
Square coffee table	C106
Coffee table Ø 51 cm - Pouf	C53
Coffee table Ø 80 cm	C8242
Island	C208
Covers for AURORA	
Armchair Art. MORPOS	C100
Sofa Art. MORDIS	C196
Chair	C57
Armchair Art. AUPOLG	C69
Sofa Art. AUDIG	C140
Sunlounger	C206
Covers for CAPRI	
Small armchairs	C69
Covers for CHELSEA	
Armchair	C79
Sofa 144 cm	C144
Sofa 209 cm	C209
Sunlounger	C199
Chairs and small armchairs SEBRI BRISE	C69
Sofa 155 cm	C155
Sofa 183 cm	C186
Table 165 x 90 cm	C180
Table 217 x 102 cm	C226
Table 80 x 80 cm	C80
Table 140 x 80 cm	C160
Covers for CONRAD	
2 stackable chairs	C57
2 stackable small armchairs	C60
2 stackable stools	C87
Covers for COSETTE	
Small armchair	C69
Table 230 x 100 cm	C226
Covers for GINGER	
Small armchair	C69
Covers for LUCE	
Armchair	C7272
Sofa	C14471
Chair and small armchair	C64
Stool	C6258
Square table 80 x 80 cm	C80
Round table Ø 80 cm	C84
Sunlounger	C206

Covers for PEVERO	
Armchair	C95
Sofa 150 cm	C153
Sofa 200 cm	C211
Small armchair	C60
Sunlounger	C206
Square table 80 x 80 cm	C80
Rectangular table 160 x 80 - 182 x 100 cm	C160
Covers for SYNTHESIS	
Chair	C5453
Small armchair	C60
Small armchair low	C6069
Armchair Art. SYPO	C8093
Deckchair Art. SDRASY	C6586
Lounge armchair Art. POLOSY	C6586
Sofa Art. SYDI - SYLD	C212
Pouf SYPU	C106
Sofa Art. SYDIG	C262
Lounge, Backrest and End modules	C162
Sunlounger	C206
Table 150 x 150 cm	C150Q
Table 230 x 100 cm	C237
Table Art. TASYQB	C92
Table Art. TAQULESY	C9276
Coffee table Art. SYTABQM	C5755
Coffee table Art. SYTABRM	C12956
Coffee table Art. SYTABR	C15484
Covers for TOSCANA	
Armchair	C82
Sofa	C175
Covers for TREBLE	
Armchair	C6586
Sofa, lounge and corner modules	C15083

ACCESSORIES / ACCESSORI / ACCESSOIRES / ZUBEHÖR

Anti-slip fabric for teak furniture 200 x 140 cm
Tessuto antiscivolo per arredi in Teak 200 x 140 cm
Tissu antidérapant pour meubles en teck 200 x 140 cm
Rutschhemmender Stoff für Teakholzmöbel, 200x 140 cm

TESANT

Cleaning kit & Paint

A kit is available for cleaning synthetic fibre and consists of a special non-foaming detergent that removes dirt and restores the appearance of the fibre, as well as a protective spray that maintains the furniture longer, nourishes the plasticisers and maintains the flexibility of the fibre. The UV filter keeps the look unchanged and extends its life over time, helping to prevent stains. This compound can also be used on iron, stone, fabric rope and aluminium to clean and maintain products properly. Another product that ensures long life for outdoor wooden furniture is Teak Oil, a teak-coloured impregnating agent capable of moisturising and restoring the furniture's original golden colour.

Per la pulizia della fibra sintetica è disponibile un Kit composto da un detergente speciale non schiumogeno che rimuove lo sporco e ripristina l'aspetto della fibra, e da uno spray di protezione che mantiene i mobili più a lungo, alimenta i plastificanti e mantiene la flessibilità della fibra. Il filtro UV mantiene inalterato l'aspetto e ne prolunga la durata nel tempo aiutando a prevenire le macchie. Questo composto può essere anche usato su ferro, pietra, corda in tessuto e alluminio per pulire e mantenere al meglio i prodotti. Altro prodotto per garantire lunga vita ai mobili da esterno in legno è l'Olio di Teak, impregnante color teak in grado di idratare e restituire l'originale colorazione dorata ai mobili.

Pour le nettoyage de la fibre synthétique, nous proposons un Kit composé d'un détergent spécial non moussant qui élimine la saleté et répare l'aspect de la fibre, et d'un spray de protection qui préserve durablement la beauté des meubles, nourrit les revêtements en plastique et entretient la flexibilité de la fibre. Le filtre UV permet de conserver son apparence et prolonge sa durée de vie tout en protégeant des taches. Ce composé, qui peut également être utilisé sur le fer, la pierre, la corde en tissu et l'aluminium, est idéal pour nettoyer et optimiser l'entretien des meubles. Un autre produit permet de préserver la beauté des meubles d'extérieur : il s'agit de l'Huile de Teck, un agent d'imprégnation de couleur teck qui hydrate et restitue leur couleur dorée originale aux meubles.

Zur Pflege der Kunstfaser ist ein Reinigungsset verfügbar. Dieses Set besteht aus einem nicht schäumenden Spezialreiniger, der Schmutz entfernt und die Faser wieder in ihrem ursprünglichen Erscheinungsbild erstrahlen lässt und aus einem Schutzspray, das die Möbelstücke pflegt und die Flexibilität der Faser erhält. Auch der enthaltene UV-Filter wirkt sich positiv auf das Erscheinungsbild aus, indem er hilft Flecken vorzubeugen und somit die Lebensdauer der Möbelstücke zu verlängern. Dieses Mittel kann auf Eisen, Stein, Stoffseilen und Aluminium angewandt werden, um damit sämtliche Produkte optimal zu reinigen und zu pflegen. Ein weiteres Produkt für die Langlebigkeit von Holzmöbeln im Außenbereich ist Teaköl, ein Imprägniermittel für Holz, das diesem Feuchtigkeit zuführt und Teakholz seine ursprüngliche goldene Farbe zurückgibt.



OLTEAK05



KITCARETEAK



KITCARESURF



NAGIMP1L

Impregnating oil for wood Nagi collection
Olio impregnante per legno collezione Nagi
Bidon d'huile de 1 litre pour bois collection Nagi
Imprägnieröl für Holz für die Kollektion Nagi



Transparent paint 2,5 lt

UCNS

Dark walnut / Noce scuro
Noyer foncé / Nussbaum

UCP

Teak / Teak / Teck / Teak

Paint 2,5 lt

UCB

White / Bianco / Blanc / Weiß

UCG

Graphite / Grafite / Graphite / Grafitgrau

UCV

English green / Verde inglese
Vert anglais / Englisch Grün

Unopiù Colour water-based impregnating agents are available to customise any environment with different shades, according to specific tastes and furnishing needs. From the most natural shades, such as teak and dark walnut, to actual colourings: white, graphite and English green.

Per caratterizzare un ambiente con tonalità differenti, assecondando il proprio gusto e le proprie esigenze d'arredo, sono disponibili gli impregnanti Unopiù Color a base acqua. Dalle tonalità più naturali come teak e noce scuro, alle vere e proprie colorazioni: bianco, grafite e verde inglese.

Les agents d'imprégnation Unopiù Color à base d'eau permettent de créer des environnements aux couleurs personnalisées en fonction des goûts et des exigences en matière d'ameublement. La palette comprend des nuances naturelles, comme le teck et le noyer foncé, ou des coloris comme le blanc, le graphite et le vert anglais. Wenn Sie ein Ambiente mit verschiedenen Farbtönen gestalten möchten, empfehlen wir für Holzoberflächen die Unopiù -Farben auf Wasserbasis. Die Auswahl umfasst natürliche Töne, wie Teak oder Nussbaum sowie klassische Farben, wie Weiß, Grafitgrau und Englisch Grün.

Materials maintenance

En -

In order to create outdoor furniture that will last outside for an infinite amount of time, it is constantly necessary to research, choose and use raw materials with unique characteristics. Unopiù materials are always selected with strict criteria to ensure unrivalled resistance to all weather conditions, even when most extreme, making the furniture ideal for any outdoor or indoor space. To meet and satisfy all requirements, Unopiù uses fine materials such as high-quality wood including teak, mahogany, iroko and pine, metals (iron, steel and aluminium), fibres and synthetic rope, leather, and fabrics.

En -

Unopiù can supply furniture in different materials and offer the right design for every taste. High-performance materials make Unopiù furniture ideal for every outdoor and indoor space: wood (teak, pine, mahogany), metal (iron, steel, aluminium), synthetic fibre, synthetic rope, fabrics, are the materials used to satisfy all customer needs. Unopiù products have the aim of improving the customer's life: to do this, the brand has chosen to rely only on high quality materials able to withstand all weather conditions, without renouncing the uniqueness of a refined design, eclipsing their shapes in multiple stylistic expressions.

It -

Per creare mobili per outdoor che resistano un tempo infinito all'aperto, è costantemente necessario ricercare, scegliere e utilizzare materie prime dalle caratteristiche uniche. I materiali Unopiù sono sempre selezionati con criteri rigorosi per garantire un'impareggiabile qualità di resistenza a tutti gli agenti atmosferici, anche i più estremi, in modo da rendere gli arredi ideali per qualsiasi spazio esterno e interno. Per rispondere e soddisfare tutte le esigenze, Unopiù utilizza materiali di eccellenza come legni pregiati quali teak, mogano, iroko e pino, metalli (ferro, acciaio, alluminio), fibre e corda sintetica, pelle, tessuti.

It -

Unopiù è in grado di fornire arredi in diversi materiali e di offrire il design giusto per ogni gusto. I materiali ad alta performance, rendono gli arredi Unopiù ideali per ogni spazio esterno e interno: legno (teak, pino, mogano), metallo (ferro, acciaio, alluminio), fibra sintetica, corda sintetica, tessuti, sono i materiali utilizzati per soddisfare tutte le esigenze dei clienti. I prodotti Unopiù hanno l'obiettivo di migliorare la vita del cliente: per farlo, il brand ha scelto di affidarsi solo a materiali di alta qualità in grado di resistere a tutti gli agenti atmosferici, senza rinunciare all'unicità di un design raffinato, eclissando le loro forme in molteplici espressioni stilistiche.

Fr -

Afin de créer des meubles d'extérieur qui dureront un temps infini à l'extérieur, il est constamment nécessaire de rechercher, de choisir et d'utiliser des matières premières aux caractéristiques uniques. Les matériaux Unopiù sont toujours sélectionnés selon des critères rigoureux afin de garantir une qualité inégalée de résistance à toutes les conditions météorologiques, même les plus extrêmes, ce qui rend le mobilier idéal pour tout espace extérieur ou intérieur. Pour répondre à toutes les exigences, Unopiù utilise des matériaux d'excellence tels que des bois précieux comme le teck, l'acajou, l'iroko et le pin, des métaux (fer, acier, aluminium), des fibres et des cordes synthétiques, du cuir, des tissus.

Fr -

Unopiù est en mesure de fournir des meubles dans différents matériaux et d'offrir le bon design pour tous les goûts. Les matériaux de haute performance rendent les meubles Unopiù idéaux pour tout espace extérieur et intérieur : bois (teck, pin, acajou), métal (fer, acier, aluminium), fibre synthétique, corde synthétique, tissus, sont les matériaux utilisés pour satisfaire toutes les exigences des clients. Les produits Unopiù ont pour objectif d'améliorer la vie du client: pour ce faire, la marque a choisi de se fier uniquement à des matériaux de haute qualité capables de résister à tous les agents atmosphériques, sans renoncer à l'unicité d'un design raffiné, éclipsant leurs formes dans de multiples expressions stylistiques.

Wood

TEAK / TEAK / TECK



En ~

We manufacture our teak products in Indonesia, near controlled regrowth plantations which are protected and guaranteed by certifications, a precise choice to reduce CO2 emissions. Each tree is carefully selected before being sent for processing, in total compliance with eco-sustainability procedures. The teak wood in warm shades used by Unopiù is sourced exclusively from controlled regrowth plantations in accordance with strict reforestation processes and is grade A only, which is the highest grade in terms of quality, by selecting the middle part of the trunk to ensure durability and dimensional stability. Naturally rich in mineral salts and oils, it is particularly resistant to atmospheric conditions such as sun, rain and sea salt, as well as being naturally resistant to parasites, making it especially suitable for outdoor use.

MAINTENANCE

Teak is a very valuable wood that by its very nature has exceptional weather resistant characteristics. Unopiù uses it by leaving it natural, without any treatment; therefore, colour variations between one element and another are to be considered normal. Any cracks that may occur on the surface are not to be considered a defect, and their visibility will vary depending on changes in temperature and humidity. Before using it for the first time, Unopiù recommends leaving the furniture in the open air for 24-48 hours, helping the reactivation of the fibres which, by nature, will expel the excess natural oil produced during storage. It is then advisable to wipe the entire surface with a damp cloth made of natural fibres such as cotton or jute. It is good practice to repeat this process periodically. When left exposed to the elements, it tends to turn silvery-grey in colour; this phenomenon is testimony to the natural state of the wood that lives and reacts to the external environment with a maturation/oxidation process that in no way alters the structural integrity of the product. The honey shade can be maintained or restored by using the specific maintenance products that Unopiù offers its customers.

It ~

Realizziamo i nostri prodotti in teak in Indonesia, vicino a piantagioni a ricrescita controllata, protette e garantite da certificazioni, una scelta precisa per ridurre le emissioni di CO2. Ogni albero viene accuratamente selezionato prima di essere destinato alla trasformazione, nel totale rispetto delle procedure di ecosostenibilità. Il legno di teak utilizzato da Unopiù, dalle calde sfumature di colore, proviene esclusivamente da piantagioni a ricrescita controllata nel rispetto dei rigidi processi di riforestazione ed è solo di grado A - il grado più elevato in termini di qualità - selezionandone la parte centrale del tronco, per garantire durabilità e stabilità dimensionale. Ricco per natura, di sali minerali ed oli, è particolarmente resistente agli agenti atmosferici quali sole, pioggia, salsedine, oltre a resistere per natura all'attacco di parassiti, per questo è particolarmente adatto all'outdoor.

MANUTENZIONE

Il teak è un legno molto pregiato che per natura ha caratteristiche di eccezionale resistenza agli agenti atmosferici. Unopiù lo utilizza lasciandolo naturale, senza alcun trattamento; pertanto, sono da considerare del tutto nella norma variazioni di colore tra un elemento e l'altro. Non sono da considerare un difetto, eventuali fessurazioni che potrebbero verificarsi in superficie, esse saranno più visibili o meno, in base ai cambiamenti di temperatura e in base al tasso di umidità. Prima del primo utilizzo, Unopiù consiglia di lasciare il mobile all'aria aperta per 24-48 ore, favorendo la riattivazione delle fibre che per natura, espelleranno l'eccesso di olio naturale, prodotto durante l'immagazzinamento, e successivamente, di passare su tutta la superficie, con un panno umido in fibra naturale quali cotone o juta. È buona abitudine, ripetere tale operazione periodicamente. Lasciato esposto agli agenti atmosferici tende ad assumere una colorazione argentea tendente al grigio; tale fenomeno è la testimonianza della naturalità del legno che vive e reagisce all'ambiente esterno con un processo di maturazione/ossidazione che non altera in nessuno modo l'integrità strutturale del prodotto. La tonalità miele potrà essere mantenuta o ripristinata grazie ai prodotti specifici per la manutenzione che Unopiù propone ai suoi clienti.

Fr ~

Nous fabriquons nos produits en teck en Indonésie, à proximité de plantations à croissance contrôlée, protégées et garanties par des certifications, un choix étudié pour réduire les émissions de CO2. Chaque arbre est soigneusement sélectionné avant d'être envoyé à la transformation, dans le respect total des procédures d'éco-durabilité. Le bois de teck utilisé par Unopiù, avec ses nuances chaudes, provient exclusivement de plantations à croissance contrôlée, selon des processus de reboisement stricts et est exclusivement du grade A – le plus élevé en termes de qualité – en sélectionnant la partie centrale du tronc pour garantir la durabilité et la stabilité dimensionnelle. Naturellement riche en sels minéraux et en huiles, il est tout particulièrement résistant aux agents atmosphériques tels que le soleil, la pluie et le sel, ainsi qu'aux parasites, ce qui le rend particulièrement adapté à une utilisation en extérieur.

ENTRETIEN

Le teck est un bois très précieux qui, par nature, présente des caractéristiques de résistance exceptionnelle aux intempéries. Unopiù l'utilise en le laissant naturel, sans aucun traitement ; par conséquent, les variations de couleur d'un élément à l'autre doivent être considérées comme tout à fait normales. Les fissures qui peuvent apparaître à la surface ne doivent pas être considérées comme un défaut, elles seront plus ou moins visibles en fonction des changements de température et d'humidité. Avant la première utilisation, Unopiù recommande de laisser le meuble à l'air libre pendant 24-48 heures, pour favoriser la réactivation des fibres qui, par nature, expulseront l'excès d'huile naturelle, produite pendant le stockage, puis d'essuyer l'ensemble de la surface avec un chiffon humide en fibres naturelles telles que le coton ou le jute. Il est recommandé de répéter cette opération régulièrement. Exposé aux intempéries, il a tendance à prendre une couleur gris argenté ; ce phénomène témoigne du caractère naturel du bois qui vit et réagit à l'environnement extérieur par un processus de maturation / oxydation qui n'altère en rien l'intégrité structurelle du produit. La teinte miel peut être entretenue ou restaurée grâce aux produits d'entretien spécifiques qu'Unopiù propose à ses clients.

Wood

MAHOGANY / MOGANO / ACAJOU



En ~

This high-quality wood is popular due to its fine grain, elegance and finish. Mahogany is a wood that comes in warm red to dark brown tones and has a tendency to darken over time, a distinctive and elegant feature. With a very pleasant appearance, in the past it was used for elegant English drawing rooms as well as vessels and fleets. It is easy to process, enabling precise and refined details to be created. Unopiù treats mahogany with a special polishing process that enhances its elegance and makes it very pleasant to the touch and aesthetically appealing.

MAINTENANCE

As far as cleaning is concerned, there are certain things to bear in mind: if the mahogany is processed and has hollows, a soft bristle brush can be used gently to clean these thoroughly. Unopiù then suggests wringing out a soft cloth, first soaked in a solution of lukewarm water with a mild liquid soap, and wiping it all over the wood. Once all the surfaces have been cleaned, dry them immediately and thoroughly. Unopiù recommends that mahogany products are used under a covered exterior, such as a pergola.

It ~

Un legno pregiato, apprezzato per la grana fine, l'eleganza e la finitura. Il mogano è un legno che offre calde tonalità dal rosso al marrone scuro e ha la tendenza a scurirsi nel tempo, un tratto distintivo ed elegante. Esteticamente molto gradevole, in passato era destinato a eleganti salotti inglesi come pure a vascelli e flotte. La facilità di lavorazione permette di realizzare dettagli precisi e raffinati. Unopiù tratta il mogano con uno speciale processo di lucidatura che ne esalta l'eleganza e che lo rende tanto gradevole al tatto e alla vista.

MANUTENZIONE

Per quanto riguarda la pulizia, ci sono delle accortezze da tenere a mente: se il mogano è lavorato e presenta parti incave, per pulirle in profondità basta usare con delicatezza un pennello a setole morbide. Unopiù suggerisce poi di strizzare un panno morbido, prima bagnato in una soluzione di acqua tiepida con un sapone liquido neutro, e passarlo sul legno in ogni sua parte. Una volta pulite tutte le superfici, asciugarle subito e accuratamente. Unopiù consiglia l'utilizzo dei prodotti in mogano sotto un esterno coperto (pergole).

Fr ~

Un bois noble, apprécié pour la finesse de son grain, son élégance et sa finition. L'acajou est un bois qui présente des tons chauds allant du rouge au brun foncé et qui a tendance à s'assombrir avec le temps, ce qui constitue une caractéristique distinctive et élégante. Très esthétique, il était autrefois destiné aux élégants salons anglais ainsi qu'aux navires et aux flottes. La facilité de travail permet de réaliser des détails précis et raffinés. Unopiù traite l'acajou avec un procédé de polissage spécial qui rehausse son élégance et le rend si agréable au toucher et au regard.

ENTRETIEN

En ce qui concerne le nettoyage, certaines précautions doivent être gardées à l'esprit : si l'acajou est travaillé et présente des creux, une brosse à poils doux peut être utilisée pour un nettoyage en profondeur. Unopiù suggère ensuite de passer sur le bois un chiffon doux, préalablement trempé dans une solution d'eau tiède additionnée d'un savon liquide neutre et essoré. Une fois que toutes les surfaces ont été nettoyées, il faut les sécher immédiatement et soigneusement. Unopiù recommande l'utilisation de produits en acajou dans les espaces extérieurs couverts (pergolas).

Wood

PINE / PINO / PIN



En ~

Unopiù uses top-quality Nordic pine for its structures, a material which is particularly resistant and durable due to the cold climate in which it grows. Unopiù's Nordic pine effectively undergoes a vacuum pressure impregnation process and is then treated with specific plant oil-based products, which strengthen its resistance to weathering. Thanks to these treatments, which also protect it from attacks by insects, mould and fungi, it is able to maintain its attractive appearance even in harsh atmospheric conditions. The life of properly impregnated and regularly maintained wood is almost unlimited.

MAINTENANCE

Unopiù's Nordic pine undergoes effective preliminary impregnation processes, providing the material surface with an adequate protective layer, which can be renewed using our specific maintenance products.

It ~

Unopiù utilizza, per realizzare le proprie strutture, pino nordico di prima qualità, materiale di particolare resistenza e durata conferitogli dal clima freddo in cui cresce. Il pino nordico di Unopiù, viene sottoposto con efficacia a un processo di impregnazione sottovuoto, successivamente viene trattato con prodotti specifici a base di olio vegetale, che ne rafforzano la resistenza agli agenti atmosferici. Grazie a questi trattamenti, che lo preservano anche da attacchi di insetti, muffe, funghi, è in grado di mantenere inalterato il suo aspetto gradevole anche di fronte all'usura degli agenti atmosferici. La durata di un buon legno impregnato e regolarmente mantenuto è pressoché illimitata.

MANUTENZIONE

Il pino nordico di Unopiù viene sottoposto ad efficaci processi di impregnazione preliminare, che forniscono alla superficie del materiale, un adeguato strato protettivo, che è possibile rinnovare, utilizzando i nostri prodotti specifici per la manutenzione.

Fr ~

Unopiù utilise pour ses structures du pin nordique de première qualité, un matériau d'une résistance et d'une durabilité particulières, conférées par le climat froid dans lequel il pousse. Le pin nordique d'Unopiù est effectivement soumis à un processus d'imprégnation sous vide et est ensuite traité avec des produits spécifiques à base d'huile végétale, qui renforcent sa résistance aux intempéries. Grâce à ces traitements, qui le protègent également des attaques d'insectes, de moisissures et de champignons, il peut conserver son bel aspect même face à l'usure due aux intempéries. La durée de vie d'un bois bien imprégné et régulièrement entretenu est pratiquement illimitée.

ENTRETIEN

Le pin nordique d'Unopiù est soumis à des processus d'imprégnation préalables efficaces, qui confèrent à la surface du matériau une couche protectrice adéquate, qui peut être renouvelée à l'aide de nos produits d'entretien spécifiques.

Metal

IRON / FERRO / FER



En ~

Iron is one of the most common elements on the planet and is characterised by high resistance to harsh weather conditions. It is the material that belongs to Unopiù's heritage and it features in some of its timelessly stylish collections. The ductility of iron lends itself very well to artisanal or industrial processing in multiple morphologies, being malleable both for creations with linear and minimalist aesthetics and for more detailed and creative products. The Unopiù wrought iron is entirely handmade by skilled craftsmen using old-fashioned techniques and is galvanised to achieve an even-looking and resistant surface. The galvanising process is commonly used to protect iron from atmospheric and water corrosion. The Unopiù wrought iron outdoor furniture combines aesthetics, durability and practicality, as it does not have to be stored inside during the winter season.

MAINTENANCE

Wash with natural mild soap, wipe with Vaseline oil once dry. In order to avoid water stagnation, when it rains it is advisable to leave it to dry in the sun before covering it.

It ~

Il ferro è uno degli elementi più comuni sul pianeta ed è caratterizzato da un'elevata resistenza a condizioni atmosferiche sfavorevoli. È il materiale che appartiene all'heritage di Unopiù e con il quale ha realizzato alcune delle sue collezioni dallo stile senza tempo. La duttilità del ferro si presta egregiamente alla lavorazione artigianale o industriale in molteplici morfologie, risultando malleabile sia per realizzazioni dall'estetica lineare ed essenziale, sia per prodotti più articolati e creativi. Il ferro battuto di Unopiù è interamente lavorato a mano da abili artigiani con le tecniche di una volta e viene zincato per ottenere una superficie omogenea e resistente. Comunemente, il processo di zincatura è utilizzato per proteggere il ferro dalla corrosione atmosferica e dell'acqua. Gli arredi da esterni in ferro battuto di Unopiù abbinano estetica, durabilità e praticità perché non devono necessariamente essere riposti all'interno durante stagione invernale.

MANUTENZIONE

Lavare con sapone neutro naturale, una volta asciugato passare olio di vasellina. Al fine di evitare ristagni d'acqua, quando piove è consigliabile farlo asciugare al sole prima di coprirlo.

Fr ~

Le fer est l'un des éléments les plus répandus sur la planète et se caractérise par une grande résistance aux conditions climatiques défavorables. C'est le matériau qui fait partie de l'héritage d'Unopiù et à partir duquel elle a créé certaines de ses collections au style intemporel. La ductilité du fer se prête très bien à la transformation artisanale ou industrielle en de multiples morphologies, étant malléable aussi bien pour des réalisations à l'esthétique linéaire et essentielle que pour des produits plus articulés et créatifs. Le fer forgé d'Unopiù est entièrement façonné à la main par des artisans expérimentés selon des techniques d'antan et galvanisé pour obtenir une surface homogène et résistante. Le processus de galvanisation est généralement utilisé pour protéger le fer de la corrosion atmosphérique et de l'eau. Les meubles d'extérieur en fer forgé d'Unopiù allient esthétique, durabilité et praticité, si bien qu'ils ne doivent pas forcément être stockés à l'intérieur pendant la saison hivernale.

ENTRETIEN

Laver avec un savon naturel neutre, une fois sec, passer de l'huile de vaseline. Afin d'éviter la stagnation de l'eau, il est conseillé, en cas de pluie, de le laisser sécher au soleil avant de le recouvrir.

Metal

ALUMINIUM / ALLUMINIO / ALUMINIUM



En ↗

Aluminium is a lightweight and strong metal which is one of the most naturally occurring elements. It has a high level of corrosion resistance, allowing the products to have excellent durability. Its high malleability and ductility and extreme lightness make it a very supple metal. In addition to being easy to handle and process, its versatility makes it suitable for producing various kinds of objects, from tables and lamps to chairs and armchairs. Aluminium is environmentally friendly, being an infinitely recyclable material that can be transformed and reintroduced into the production cycle, taking on a new aesthetic and functional value each time while being kind to the environment. The Unopiù aluminium alloy furniture, which is lightweight and easy to move despite its elegance, is treated with a coating that involves the electrostatic application of thermosetting polyester powders, with subsequent polymerisation in an oven at temperatures of 180-200°.

MAINTENANCE

Wash with natural mild soap, wipe with Vaseline oil once dry. In order to avoid water stagnation, when it rains it is advisable to leave it to dry in the sun before covering it.

It ↗

L'alluminio è un metallo leggero e robusto, uno degli elementi più presenti in natura. Ha un elevato livello di resistenza alla corrosione, il che consente ai prodotti di avere un'eccellente durata. L'ottima malleabilità e duttilità e l'estrema leggerezza lo rendono un metallo altamente plastico. Oltre a essere maneggevole e di facile lavorazione – la sua versatilità lo rende adatto alla produzione di oggetti di diversa natura, da tavoli a lampade fino a sedie e poltrone – l'alluminio è rispettoso dell'ambiente, essendo un materiale infinitamente riciclabile che può essere trasformato e reimmesso all'interno del ciclo produttivo, assumendo ogni volta una nuova valenza estetica e funzionale nel rispetto dell'ambiente. I mobili in lega di alluminio di Unopiù, leggeri e pratici da spostare pur nella loro eleganza, vengono trattati con una verniciatura che prevede l'applicazione elettrostatica di polveri poliestere termoindurenti, con successiva polimerizzazione in forno a temperature di 180-200°.

MANUTENZIONE

Lavare con sapone neutro naturale, una volta asciugato passare olio di vasellina. Al fine di evitare ristagni d'acqua, quando piove è consigliabile farlo asciugare al sole prima di coprirlo.

Fr ↗

L'aluminium est un métal léger et résistant, l'un des éléments les plus présents dans la nature. Il présente un niveau élevé de résistance à la corrosion, ce qui permet aux produits d'avoir une excellente durabilité. Son excellente malléabilité, sa ductilité et son extrême légèreté en font un métal très plastique. En plus d'être pratique et facile à travailler – sa polyvalence le rend adapté à la production d'objets de toutes sortes, des tables aux lampes en passant par les chaises et les fauteuils – l'aluminium est respectueux de l'environnement, étant un matériau recyclable à l'infini qui peut être transformé et réintroduit dans le cycle de production, prenant à chaque fois une nouvelle valeur esthétique et fonctionnelle, dans le respect de l'environnement. Légers et faciles à déplacer malgré leur élégance, les meubles en alliage d'aluminium d'Unopiù sont traités avec un revêtement qui consiste en l'application électrostatique de poudres de polyester thermodurcissables, suivie d'une polymérisation dans un four à des températures comprises entre 180 et 200°.

ENTRETIEN

Laver avec un savon naturel neutre, une fois sec, passer de l'huile de vaseline. Afin d'éviter la stagnation de l'eau, il est conseillé, en cas de pluie, de le laisser sécher au soleil avant de le recouvrir.

Metal

STAINLESS STEEL / ACCIAIO INOX / ACIER INOXYDABLE

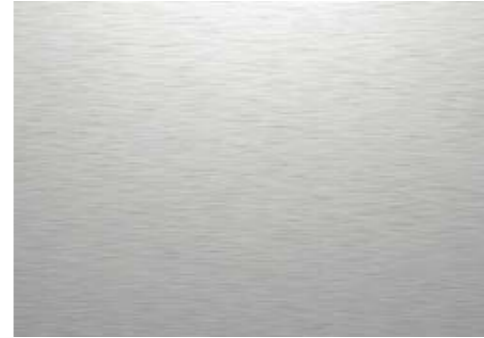

En ↗

Steel is an alloy consisting mainly of iron and carbon. Stainless steel is a durable stainless material with exceptional technical and aesthetic properties. High corrosion resistance makes it more long-lasting and reliable over time. The contemporary appeal of steel is perfectly matched by its extreme versatility, making it a superior material with an almost infinite number of uses. Unopiù chooses steel as the go-to material for many of its outdoor products, taking advantage of its exceptional characteristics to create durable, high-quality furniture in a refined version, successfully enhancing a material that is considered industrial by combining it with elegantly designed pieces. Unopiù uses AISI304 stainless steel, a fine material with high resistance in harsh environments, especially to corrosion and all weathering.

MAINTENANCE

It is an exceptional material, able to withstand weathering while maintaining its appeal over time. To maintain it, it must be cleaned and polished with specific products and when unused for prolonged periods and exposed to UV rays, Unopiù recommends storing the furniture in a sheltered place.

It ↗

L'acciaio è una lega composta principalmente da ferro e carbonio. L'acciaio inox è un materiale inossidabile dalle eccezionali caratteristiche tecniche, estetiche e dalle straordinarie proprietà di durata. L'alta resistenza alla corrosione lo rende maggiormente duraturo e affidabile nel tempo. Il fascino contemporaneo dell'acciaio si sposa perfettamente a una estrema versatilità, rendendolo un materiale superiore dagli usi pressoché infiniti. L'acciaio è il materiale d'elezione per molti prodotti per outdoor di Unopiù, che sfrutta le eccezionali caratteristiche dell'acciaio per creare arredi durevoli e di alta qualità in una versione raffinata, valorizzando con successo un materiale considerato industriale legandolo a oggetti dall'elegante design. Unopiù utilizza acciaio inox AISI304, materiale nobile dalla elevata resistenza in ambienti aggressivi, in particolare alla corrosione e a tutti gli agenti atmosferici.

MANUTENZIONE

È un materiale eccezionale, capace di resistere alle sollecitazioni degli agenti atmosferici mantenendo nel tempo il suo appeal. Per mantenerlo deve essere pulito e lucidato con prodotti specifici e in caso di periodi prolungati di inutilizzo con esposizione ai raggi UV, Unopiù consiglia di riporre gli arredi in un luogo riparato.

Fr ↗

L'acier est un alliage composé principalement de fer et de carbone. L'acier inoxydable est un matériau inoxydable doté de propriétés techniques, esthétiques et de durabilité exceptionnelles. Sa grande résistance à la corrosion le rend plus durable et plus fiable au fil du temps. L'attrait contemporain de l'acier va de pair avec son extrême polyvalence, ce qui en fait un matériau de qualité supérieure aux emplois presque infinis. Unopiù exploite les caractéristiques exceptionnelles de l'acier – son matériau d'élection – pour créer des meubles durables et de qualité supérieure dans une version raffinée, parvenant à valoriser un matériau considéré comme industriel en l'associant à des objets au design élégant. Unopiù utilise l'acier inoxydable AISI304, un matériau noble qui présente une grande résistance aux environnements agressifs, notamment à la corrosion et à toutes les intempéries.

ENTRETIEN

Il s'agit d'un matériau exceptionnel, en mesure de résister aux intempéries tout en conservant son attrait au fil du temps. Pour l'entretenir, il faut le nettoyer et le polir avec des produits spécifiques et, en cas d'inutilisation prolongée avec exposition aux rayons UV, Unopiù recommande de stocker le meuble dans un endroit abrité.

Synthetic Fibre

WAPROLACE®



En ~

WaProLace® is a state-of-the-art synthetic material, registered by Unopiù and designed to withstand the challenges of outdoor environments - such as the attack of climatic agents, salt, chlorine, mould, parasites, fungi, bacteria and sunscreens - while maintaining its colour and characteristics and perfectly reproducing the warm, genuine appearance of natural fibre texture. WaProLace® is a recyclable and biodegradable material that is lightweight, smooth to the touch, impermeable to liquids, stain-resistant, antistatic and easy to clean; it is resistant to temperature variations and can withstand harsh winter weather. WaProLace® synthetic fibre is made of polyethylene, treated to make it anti-oxidising, UV-resistant and fireproof. Unopiù's decision to use WaProLace® in the creation of many of its outdoor furniture lines reflects the company's commitment to creating weather-resistant furniture. Both aesthetically and in terms of performance, the remarkable features of this synthetic fibre are guaranteed, making WaProLace® a high-quality and sustainable material.

MAINTENANCE

WaProLace® fibre can be washed with water and mild soap, and rinsed well. Once dry, it can be treated with a special product that revives the colour and protects the fibres. Everything you need is contained in the Unopiù cleaning kit.

It ~

WaProLace® è un materiale sintetico di ultima generazione, registrato da Unopiù e progettato per resistere alle sfide degli ambienti outdoor – come l'attacco di agenti climatici, salsedine, cloro, muffe, parassiti, funghi, batteri e creme solari – mantenendo sempre inalterati colore e caratteristiche e riproducendo perfettamente l'aspetto caldo e genuino della tessitura delle fibre naturali. WaProLace® è un materiale riciclabile e biodegradabile, leggero, liscio al tatto, impermeabile ai liquidi, antimacchia, antistatico e semplice da pulire; è resistente alle variazioni di temperatura e può sopportare un clima invernale rigido. La fibra sintetica WaProLace® è realizzata in polietilene, trattato per renderlo antiossidante, resistente ai raggi UV ed ignifugo. La decisione di Unopiù di utilizzare WaProLace® nella creazione di molte delle sue linee di arredo per esterni rispecchia l'impegno dell'azienda nel creare mobili resistenti agli agenti atmosferici. Sia a livello estetico sia prestazionale, le notevoli prerogative di questa fibra sintetica sono garantite, rendendo WaProLace® un materiale sostenibile di alta qualità ed eleganza d'uso.

MANUTENZIONE

La fibra WaProLace® può essere lavata con acqua e sapone neutro, e ben risciacquata, una volta asciugata può essere trattata con apposito prodotto che ravviva il colore e protegge le fibre. Tutto il necessario è contenuto nel kit di pulizia Unopiù.

Fr ~

WaProLace® est un matériau synthétique de pointe, enregistré par Unopiù et conçu pour résister aux défis des environnements extérieurs – tels que l'attaque des agents climatiques, du sel, du chlore, des moisissures, des parasites, des champignons, des bactéries et des crèmes solaires – tout en conservant sa couleur et ses caractéristiques et en reproduisant parfaitement l'aspect chaleureux et authentique de la texture de la fibre naturelle. WaProLace® est un matériau recyclable et biodégradable qui est léger, lisse au toucher, imperméable aux liquides, résistant aux taches, antistatique et facile à nettoyer ; résiste aux variations de température et aux rigueurs de l'hiver. La fibre synthétique WaProLace® est composée de polyéthylène traité pour la rendre antioxydante, résistante aux UV et ignifuge. La décision d'Unopiù d'utiliser WaProLace® pour la création de nombreuses lignes de mobilier d'extérieur reflète l'engagement de l'entreprise dans la création de meubles résistants aux intempéries. Tant sur le plan esthétique qu'en termes de performances, les propriétés remarquables de cette fibre synthétique sont garanties, ce qui fait de WaProLace® un matériau durable d'une qualité exceptionnelle et d'une grande élégance d'utilisation.

ENTRETIEN

La fibre WaProLace® peut être lavée avec de l'eau et du savon neutre, bien rincée et, une fois séchée, traitée avec un produit spécial qui ravive la couleur et protège les fibres. Le kit de nettoyage Unopiù contient tout ce dont vous avez besoin.

Rope

POLYOLEFIN ROPE / CORDA POLIOLEFINICA / CORDE POLYOLÉFINE



En ~

Compared to any other man-made fibre, including polyester and nylon, polyolefin rope is more resistant to chemicals - at room temperature, this rope has a high resistance to the effects of alkaline acids. Polyolefin rope is resistant to fungi and bacteria and is well tolerated by living tissue, as long as it does not contain any special stabilisers or additives that - if they were to transpire to the outside - could alter its strength properties. The polyolefin rope chosen by Unopiù is solution-dyed using pigments purchased from a few selected, highly qualified suppliers: this dyeing process guarantees not only excellent colour uniformity but also very high resistance. Polyolefin rope perfectly combines the typical characteristics of the finest natural fabrics, such as their soft, pleasant feel and practicality, with the strength of a synthetic fibre.

MAINTENANCE

Woven polyolefin rope is a material that provides excellent performance in outdoor environments due to its practicality and softness, which is typical of natural fabrics, combined with the extreme resistance resulting from the use of a synthetic material. To keep its attractive appearance over time, it does not require any maintenance treatment, but if desired, it can be washed periodically to remove dirt and dust that may get stuck in the weave. To avoid damaging the material during this process, Unopiù suggests using lukewarm clean water (max. 30°), a mild detergent such as Marseille soap or one for delicate fabrics (never bleach or ammonia), and a soft synthetic brush. After washing, Unopiù recommends drying the rope in the shade, possibly in the open air but away from heat sources.

It ~

Rispetto a qualsiasi altra fibra artificiale, inclusi poliestere e nylon, la corda poliolefinica è maggiormente resistente agli agenti chimici – a temperatura ambiente, questa corda presenta un'elevata resistenza agli effetti degli acidi alcalini. La corda in polipropilene è resistente a funghi e batteri ed è ben tollerata dai tessuti vivi, purché non contenga stabilizzanti o additivi particolari che – se dovessero traspirare verso l'esterno – potrebbero alterarne le proprietà di resistenza. La corda poliolefinica scelta da Unopiù è tinta in massa utilizzando pigmenti acquistati da pochi fornitori selezionati, altamente qualificati: questo processo di tintura garantisce non solo un'ottima uniformità del colore ma anche una resistenza molto elevata. La corda poliolefinica combina perfettamente le caratteristiche tipiche dei tessuti naturali più pregiati, come morbidezza, piacevolezza al tatto e praticità, e la resistenza di una fibra sintetica.

MANUTENZIONE

La corda poliolefinica intrecciata è un materiale che offre ottime prestazioni negli ambienti esterni grazie alla sua praticità e morbidezza, tipiche dei tessuti naturali, unite all'estrema resistenza dovuta all'utilizzo di un materiale sintetico. Per mantenersi bella nel tempo non necessita di alcun trattamento di manutenzione, ma se lo si desidera si può provvedere a lavarla periodicamente per eliminare sporco e polvere che possono insinuarsi nell'intreccio. Per non danneggiare il materiale durante questa operazione, Unopiù suggerisce di utilizzare acqua pulita tiepida (max 30°), un detergente neutro come il sapone di Marsiglia o uno per i tessuti delicati (mai candeggina o ammoniaca), e infine una spazzola morbida sintetica. Una volta terminato il lavaggio, Unopiù consiglia di far asciugare la corda all'ombra, possibilmente all'aria aperta ma lontano da fonti di calore.

Fr ~

Comparée à toute autre fibre synthétique, y compris le polyester et le nylon, la corde polyoléfine est plus résistante aux produits chimiques – à température ambiante, cette corde présente une résistance élevée aux effets des acides alcalins. La corde polyoléfine est résistante aux champignons et aux bactéries et bien tolérée par les tissus vivants, pour autant qu'elle ne contienne pas de stabilisateurs spéciaux ou d'additifs qui, s'ils se propageaient à l'extérieur, pourraient en altérer les propriétés de résistance. La corde polyoléfine choisie par Unopiù est teintée dans la masse à l'aide de pigments achetés auprès de quelques fournisseurs sélectionnés et hautement qualifiés : ce procédé de teinture garantit non seulement une excellente uniformité des couleurs, mais aussi une très grande résistance. La corde polyoléfine combine parfaitement les caractéristiques typiques des meilleurs tissus naturels, telles que la douceur, le côté agréable au toucher et la praticité, avec la résistance d'une fibre synthétique.

ENTRETIEN

La corde en polyoléfine tissée est un matériau qui offre d'excellentes performances dans les environnements extérieurs grâce à sa praticité et à sa douceur, typiques des tissus naturels, combinées à l'extrême résistance résultant de l'utilisation d'un matériau synthétique. Pour rester belle au fil du temps, elle ne requiert aucun traitement d'entretien, mais si vous le souhaitez, il est possible de la laver régulièrement pour éliminer la saleté et la poussière qui peuvent s'infiltrer dans le tissage. Pour éviter d'endommager le matériau lors de cette opération, Unopiù conseille d'utiliser de l'eau propre tiède (max. 30°), un détergent neutre comme le savon de Marseille ou un détergent pour tissus délicats (jamais d'eau de Javel ni d'ammoniaque) et, enfin, une brosse synthétique douce. Après le lavage, Unopiù recommande de faire sécher la corde à l'ombre, si possible à l'air libre, mais loin des sources de chaleur.

Fabrics

ACRYLIC FABRICS / TESSUTI SINTETICI / TISSUS ACRYLIQUES

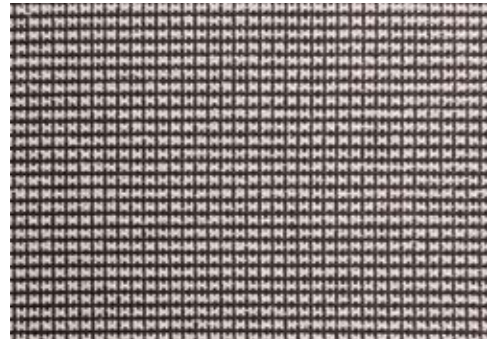

En ~

Unopiù offers a wide range of fabrics that are resistant to sunlight and bad weather, available in a range of no less than 39 colours in different weights and finishes, enabling you to create multiple colour combinations of seat, back and decorative cushions. The fabrics are made of 100% acrylic, solution-dyed with stain- and mould-resistant fibre, and are characterised by their soft, cool and pleasant feel. All the Unopiù fabrics are certified as Standard 100 by Oeko-Tex® - the textile industry's highest safety standard.

MAINTENANCE

Acrylic fabrics should be brushed occasionally and can be washed by hand or in the washing machine (max. 30°) without a spin cycle using a mild soap such as Marseille soap. Unopiù recommends drying them naturally in sunlight. When ironing them, insert a damp cloth between the iron and the fabric to protect against excessive heat and to restore the fabric's natural softness. During the winter or long periods of inactivity or persistent rain, Unopiù suggests removing the cushions. All the cleaning and washing instructions can be found on the label inside the cushion.

It ~

Unopiù propone un ampio ventaglio di tessuti resistenti alla luce solare e alle intemperie, disponibili in una gamma di ben 39 colori in diverse grammature e finiture, il che consente di realizzare molteplici combinazioni cromatiche tra cuscini di seduta, schienale e cuscini decorativi. I tessuti sono realizzati in acrilico 100%, tinto in massa con fibra antimacchia e antimuffa, e si contraddistinguono per la morbidezza, freschezza e piacevolezza al tatto. Tutti i tessuti Unopiù sono certificati Standard 100 by Oeko-Tex® – il più alto standard di sicurezza dell'industria tessile.

MANUTENZIONE

I tessuti acrilici vanno spazzolati occasionalmente e possono essere lavati a mano o in lavatrice (massimo a 30°) senza centrifuga utilizzando un sapone neutro, come quello di Marsiglia. Unopiù consiglia l'asciugatura naturale alla luce del sole. Effettuare la stiratura inserendo un panno umido tra ferro da stiro e tessuto, a protezione dell'eccessivo calore e per restituire al tessuto la sua naturale morbidezza. Durante l'inverno e in caso di lunghi periodi di inutilizzo o di pioggia persistente, Unopiù suggerisce di riporre al riparo i cuscini. Tutte le istruzioni di pulizia e lavaggio sono presenti sull'etichetta all'interno del cuscino.

Fr ~

Unopiù propose une large gamme de tissus résistants à la lumière du soleil et aux intempéries, disponibles dans une palette de 39 couleurs, dans différents poids et finitions, permettant de multiples combinaisons de couleurs pour les coussins d'assise, de dossier et de décoration. Les tissus sont composés à 100 % d'acrylique, teintés dans la masse avec des fibres résistantes aux taches et aux moisissures, et se caractérisent par leur douceur, leur fraîcheur et leur toucher agréable. Tous les tissus Unopiù sont certifiés Standard 100 par Oeko-Tex® - la norme de sécurité la plus élevée de l'industrie textile.

ENTRETIEN

Les tissus en acrylique doivent être brossés de temps en temps et peuvent être lavés à la main ou au lave-linge (max. 30°) sans essorage avec un savon doux tel que le savon de Marseille. Unopiù recommande le séchage naturel à la lumière du soleil. Repasser en plaçant une pattemouille entre le fer et le tissu afin de le protéger contre la chaleur excessive et de lui redonner sa douceur naturelle. Pendant l'hiver et en cas de longues périodes d'inactivité ou de pluie persistante, Unopiù conseille de mettre les coussins à l'abri. Toutes les instructions de nettoyage et de lavage figurent sur l'étiquette à l'intérieur du coussin.

Fabrics

RECYCLED PET / PET RICICLATO / PET RECYCLÉ



En ~

The Unopiù rug collection is made of 100% recycled PET. The continuous polyester yarn is produced by recycling common PET bottles, which are collected and sent for recycling to create a handmade, innovative and sustainable product. Unopiù carpets made of recycled PET are certified as Standard 100 by Oeko-Tex® – the textile industry's highest safety standard, guaranteed by independent institutes - which certifies products in the textile industry that have passed specific tests for harmful substances and meet certain ecological and safety requirements. Oeko-Tex® certification also ensures that products comply with REACH, the European regulation on the Registration, Evaluation, Authorisation and Restriction of Chemicals. The absence of substances that are hazardous to human health - and therefore potentially poisonous to ecosystems - also guarantees that the materials bearing this certification are environmentally sustainable.

MAINTENANCE

Rugs made of recycled PET should be washed outdoors with mild soap and water, rubbing them by hand with gentle movements.

It ~

La collezione di tappeti Unopiù è realizzata al 100% in PET riciclato. Il filo continuo di poliestere è prodotto riciclando comuni bottiglie in PET, raccolte e avviate al riciclo per creare un prodotto artigianale, innovativo e sostenibile. I tappeti Unopiù in PET riciclato hanno la certificazione Standard 100 by Oeko-Tex® – il più alto standard di sicurezza dell'industria tessile, garantito da istituti indipendenti – che certifica prodotti nell'industria tessile che hanno superato test specifici per sostanze nocive e soddisfano determinati requisiti ecologici e di sicurezza. La certificazione Oeko-Tex® garantisce inoltre che i prodotti siano conformi al REACH (Registrazione, Valutazione, Autorizzazione e Restrizione delle sostanze chimiche), il regolamento europeo sulla registrazione, valutazione, autorizzazione e restrizione delle sostanze chimiche. L'assenza di sostanze pericolose per la salute dell'uomo – e quindi potenziali veleni per gli ecosistemi – garantisce anche la sostenibilità ambientale dei materiali che portano questa certificazione.

MANUTENZIONE

I tappeti in PET riciclato vanno lavati all'aperto con acqua e sapone neutro, strofinandoli a mano con movimenti leggeri.

Fr ~

La collection de tapis Unopiù est entièrement composée de PET recyclé. Le fil de polyester continu s'obtient en recyclant des bouteilles PET ordinaires, qui sont collectées et envoyées au recyclage pour créer un produit artisanal, innovant et durable. Les tapis Unopiù en PET recyclé sont certifiées Standard 100 par Oeko-Tex® – la norme de sécurité la plus élevée de l'industrie textile, garantie par des instituts indépendants – qui certifie les produits de l'industrie textile ayant passé des tests spécifiques pour les substances nocives et répondant à certaines exigences en matière d'écologie et de sécurité. La certification Oeko-Tex® garantit également que les produits sont conformes au REACH (Registration, Evaluation, Authorisation and Restriction of Chemicals), le règlement européen en matière d'enregistrement, d'évaluation, d'autorisation et de restriction des substances chimiques. L'absence de substances dangereuses pour la santé humaine – et donc de poisons potentiels pour les écosystèmes – garantit également la durabilité environnementale des matériaux portant cette certification.

ENTRETIEN

Les tapis en PET recyclé doivent être lavés en plein air avec de l'eau et du savon doux, en les frottant à la main avec des mouvements délicats.

Stores and info

ITALY

MILANO

Via Pontaccio, 9 - 20121 Milano
Tel. +39 02 72094197

GENOVA

Via 12 Ottobre, 94/R
16121 Genova
Tel. +39 010 2759165

TORINO

Corso Marche, 36 - 10146 Torino
Tel. +39 011 4240098

VITERBO

S. S. Ortana, km 14,500
01038 Soriano nel Cimino
Tel. +39 0761 7581

SPAIN

MADRID

Calle Lagasca, 73
28001 Madrid
Tel. +34 91 659 26 20

FRANCE

PARIS

212 boulevard Saint Germain
75007 Paris
Tel. +33 1 55 35 00 42

BORDEAUX

55, Rue de Touleyre, RD 1113
33140 Cadaujac
Tél. +33 (0) 5 56 30 01 32

CANNES

Palace Center 1, Z.I. des Tourrades
06210 Mandelieu
Tél. +33 (0) 4 92 19 57 77

MARSEILLE

286, Avenue du Millet, Z.I. Les Paluds
13400 Aubagne
Tél. +33 (0) 4 42 18 60 80

GERMANY

MÜNCHEN

Sendlinger Str. 10,
80331 München
Tel. +49 (0) 89 - 512 666 800

ORDERS PROJECTS AND ESTIMATES

ufficiotecnico@unopiu.it
T +39 0761 758 888
lun-ven 10-13 / 15-19 / sab 10-19

CONTRACT

T +39 0761 758986
contract@unopiu.it

CUSTOMER SERVICE

T +39 0761 758 111
assistenza.clienti@unopiu.it
customer.service@unopiu.co.uk - ENG
kundenservice@unopiu.de - DE
service.apresvente@unopiu.fr - FR
postventa@unopiu.es - ES

ORDERS

ordini@unopiu.it - IT
order@unopiu.co.uk - ENG
estero@unopiu.it - EU / WORLD - UK - AT - CH
pedidos@unopiu.es - ES
info@unopiu.fr - FR
info@unopiu.de - DE

www.unopiu.it

ECOLIGHT

Unopiù, sensitive and attentive to the protection of the environment, complies with the European RoHS/WEEE standard. It is part of the ECOLIGHT consortium that provides for the collection and the disposal of end-of-life products according to strictly ecological standards.

FACEBOOK

facebook.com/unopiu/

INSTAGRAM

instagram.com/unopiu.official/

E condividi le tue foto con l'hashtag
#unopiu



FSC
www.fsc.org

The mark of
responsible forestry

FSC™ C201162

Unopiù is an FSC™ Forest Stewardship Council™ certified company, guaranteeing the quality of the materials used and respect for nature. Certificate TUEV-COC-002147



ISO 9001
Certificato n° 452255 QM08

—
Project:
YellowPark

Testi a cura di:
Francesca Tagliabue

Photos by:
Fabrizio Bergamo
Adriano Brusaferrì
Francesco Caredda
Giulio Ghirardi
Mattia Greggi
Mauro Mattioli
Thomas Pagani
Alberto Strada
Pierrick Verny
Gionata Xerra

Printed:
May 2024

Unopiù S.p.A

Headquarters
S.S. Ortana Km. 14,5
01038 Soriano nel Cimino (VT)

Registered Office
Via Pontaccio, 9
20121 Milano

info@unopiu.it
marketing@unopiu.it

unopiu.com

